

Quantum Elite and Quantum Connect

Videowall Processing Systems

PRELIMINARY



Safety Instructions

Safety Instructions • English

⚠ WARNING: This symbol, , when used on the product, is intended to alert the user of the presence of uninsulated dangerous voltage within the product's enclosure that may present a risk of electric shock.

ATTENTION: This symbol, , when used on the product, is intended to alert the user of important operating and maintenance (servicing) instructions in the literature provided with the equipment.

For information on safety guidelines, regulatory compliances, EMI/EMF compatibility, accessibility, and related topics, see the Extron Safety and Regulatory Compliance Guide, part number 68-290-01, on the Extron website, www.extron.com.

Sicherheitsanweisungen • Deutsch

WARNUNG: Dieses Symbol , auf dem Produkt soll den Benutzer darauf aufmerksam machen, dass im Inneren des Gehäuses dieses Produktes gefährliche Spannungen herrschen, die nicht isoliert sind und die einen elektrischen Schlag verursachen können.

VORSICHT: Dieses Symbol , auf dem Produkt soll dem Benutzer in der im Lieferumfang enthaltenen Dokumentation besonders wichtige Hinweise zur Bedienung und Wartung (Instandhaltung) geben.

Weitere Informationen über die Sicherheitsrichtlinien, Produkthandhabung, EMI/EMF-Kompatibilität, Zugänglichkeit und verwandte Themen finden Sie in den Extron-Richtlinien für Sicherheit und Handhabung (Artikelnummer 68-290-01) auf der Extron-Website, www.extron.com.

Instrucciones de seguridad • Español

ADVERTENCIA: Este símbolo, , cuando se utiliza en el producto, avisa al usuario de la presencia de voltaje peligroso sin aislar dentro del producto, lo que puede representar un riesgo de descarga eléctrica.

ATENCIÓN: Este símbolo, , cuando se utiliza en el producto, avisa al usuario de la presencia de importantes instrucciones de uso y mantenimiento recogidas en la documentación proporcionada con el equipo.

Para obtener información sobre directrices de seguridad, cumplimiento de normativas, compatibilidad electromagnética, accesibilidad y temas relacionados, consulte la Guía de cumplimiento de normativas y seguridad de Extron, referencia 68-290-01, en el sitio Web de Extron, www.extron.com.

Instructions de sécurité • Français

AVERTISSEMENT : Ce pictogramme, , lorsqu'il est utilisé sur le produit, signale à l'utilisateur la présence à l'intérieur du boîtier du produit d'une tension électrique dangereuse susceptible de provoquer un choc électrique.

ATTENTION : Ce pictogramme, , lorsqu'il est utilisé sur le produit, signale à l'utilisateur des instructions d'utilisation ou de maintenance importantes qui se trouvent dans la documentation fournie avec le matériel.

Pour en savoir plus sur les règles de sécurité, la conformité à la réglementation, la compatibilité EMI/EMF, l'accessibilité, et autres sujets connexes, lisez les informations de sécurité et de conformité Extron, réf. 68-290-01, sur le site Extron, www.extron.com.

Istruzioni di sicurezza • Italiano

AVVERTENZA: Il simbolo, , se usato sul prodotto, serve ad avvertire l'utente della presenza di tensione non isolata pericolosa all'interno del contenitore del prodotto che può costituire un rischio di scosse elettriche.

ATTENZIONE: Il simbolo, , se usato sul prodotto, serve ad avvertire l'utente della presenza di importanti istruzioni di funzionamento e manutenzione nella documentazione fornita con l'apparecchio.

Per informazioni su parametri di sicurezza, conformità alle normative, compatibilità EMI/EMF, accessibilità e argomenti simili, fare riferimento alla Guida alla conformità normativa e di sicurezza di Extron, cod. articolo 68-290-01, sul sito web di Extron, www.extron.com.

Instrukcje bezpieczeństwa • Polska

OSTRZEŻENIE: Ten symbol, , gdy używany na produkt, ma na celu poinformować użytkownika o obecności izolowanego i niebezpiecznego napięcia wewnątrz obudowy produktu, który może stanowić zagrożenie porażenia prądem elektrycznym.

UWAGI: Ten symbol, , gdy używany na produkt, jest przeznaczony do ostrzeżenia użytkownika ważne operacyjne oraz instrukcje konserwacji (obsługi) w literaturze, wyposażone w sprzęt.

Informacji na temat wytycznych w sprawie bezpieczeństwa, regulacji wzajemnej zgodności, zgodność EMI/EMF, dostępności i Tematy pokrewne, zobacz Extron bezpieczeństwa i regulacyjnego zgodności przewodnik, część numer 68-290-01, na stronie internetowej Extron, www.extron.com.

Инструкция по технике безопасности • Русский

ПРЕДУПРЕЖДЕНИЕ: Данный символ, , если указан на продукте, предупреждает пользователя о наличии неизолированного опасного напряжения внутри корпуса продукта, которое может привести к поражению электрическим током.

ВНИМАНИЕ: Данный символ, , если указан на продукте, предупреждает пользователя о наличии важных инструкций по эксплуатации и обслуживанию в руководстве, прилагаемом к данному оборудованию.

Для получения информации о правилах техники безопасности, соблюдении нормативных требований, электромагнитной совместимости (ЭМП/ЭДС), возможности доступа и других вопросах см. руководство по безопасности и соблюдению нормативных требований Extron на сайте Extron: www.extron.com, номер по каталогу - 68-290-01.

安全说明 • 简体中文

警告:  产品上的这个标志意在警告用户该产品机壳内有暴露的危险电压，有触电危险。

注意:  产品上的这个标志意在提示用户设备随附的用户手册中有重要的操作和维护(维修)说明。

关于我们产品的安全指南、遵循的规范、EMI/EMF 的兼容性、无障碍使用的特性等相关内容，敬请访问 Extron 网站，www.extron.com，参见 Extron 安全规范指南，产品编号 68-290-01。

安全記事 • 繁體中文

警告: ⚠ 若產品上使用此符號, 是為了提醒使用者, 產品機殼內存在著可能會導致觸電之風險的未絕緣危險電壓。

注意: ⚠ 若產品上使用此符號, 是為了提醒使用者, 設備隨附的用戶手冊中有重要的操作和維護 (維修) 說明。

有關安全性指導方針、法規遵守、EMI/EMF 相容性、存取範圍和相關主題的詳細資訊, 請瀏覽 Extron 網站: www.extron.com。然後參閱《Extron 安全性與法規遵守手冊》, 準則編號 68-290-01。

安全上のご注意 • 日本語

警告: この記号 ⚠ が製品上に表示されている場合は、筐体内に絶緣されていない高電圧が流れ、感電の危険があることを示しています。

注意: この記号 ⚠ が製品上に表示されている場合は、本機の取扱説明書に記載されている重要な操作と保守(整備)の指示についてユーザーの注意を喚起するものです。

安全上のご注意、法規遵守、EMI/EMF適合性、その他の関連項目については、エクストロンのウェブサイト www.extron.com より『Extron Safety and Regulatory Compliance Guide』(P/N 68-290-01) をご覧ください。

안전 지침 • 한국어

경고: 이 기호 ⚠가 제품에 사용될 경우, 제품의 인클로저 내에 있는 접지되지 않은 위험한 전류로 인해 사용자가 감전될 위험이 있음을 경고합니다.

주의: 이 기호 ⚠가 제품에 사용될 경우, 장비와 함께 제공된 책자에 나와 있는 주요 운영 및 유지보수(정비) 지침을 경고합니다.

안전 가이드라인, 규제 준수, EMI/EMF 호환성, 접근성, 그리고 관련 항목에 대한 자세한 내용은 Extron 웹 사이트(www.extron.com)의 Extron 안전 및 규제 준수 안내서, 68-290-01 조항을 참조하십시오.

Copyright

© 2011-2020 Extron Electronics. All rights reserved. www.extron.com

Trademarks

All trademarks mentioned in this guide are the properties of their respective owners.

The following registered trademarks (®), registered service marks (SM), and trademarks (TM) are the property of RGB Systems, Inc. or Extron Electronics (see the current list of trademarks on the [Terms of Use](#) page at www.extron.com):

Registered Trademarks (®)

Extron, Cable Cubby, ControlScript, CrossPoint, DTP, eBUS, EDID Manager, EDID Minder, Flat Field, FlexOS, Glitch Free, Global Configurator, Global Scriptor, GlobalViewer, Hideaway, HyperLane, IP Intercom, IP Link, Key Minder, LinkLicense, LockIt, MediaLink, MediaPort, NetPA, PlenumVault, PoleVault, PowerCage, PURE3, Quantum, ShareLink, Show Me, SoundField, SpeedMount, SpeedSwitch, StudioStation, System *INTEGRATOR*, TeamWork, TouchLink, V-Lock, VideoLounge, VN-Matrix, VoiceLift, WallVault, WindoWall, XPA, XTP, XTP Systems, and ZipClip

Registered Service Mark (SM): S3 Service Support Solutions

Trademarks (TM)

AAP, AFL (Accu-RATE Frame Lock), ADSP (Advanced Digital Sync Processing), Auto-Image, AVEdge, CableCover, CDRS (Class D Ripple Suppression), Codec Connect, DDSP (Digital Display Sync Processing), DMI (Dynamic Motion Interpolation), Driver Configurator, DSP Configurator, DSVP (Digital Sync Validation Processing), eLink, EQIP, Everlast, FastBite, Flex55, FOX, FOXBOX, IP Intercom HelpDesk, MAAP, MicroDigital, Opti-Torque, PendantConnect, ProDSP, QS-FPC (QuickSwitch Front Panel Controller), Room Agent, Scope-Trigger, SIS, Simple Instruction Set, Skew-Free, SpeedNav, Triple-Action Switching, True4K, Vector 4K, WebShare, XTRA, and ZipCaddy

FCC Class A Notice

This equipment has been tested and found to comply with the limits for a Class A digital device, pursuant to part 15 of the FCC rules. The Class A limits provide reasonable protection against harmful interference when the equipment is operated in a commercial environment. This equipment generates, uses, and can radiate radio frequency energy and, if not installed and used in accordance with the instruction manual, may cause harmful interference to radio communications. Operation of this equipment in a residential area is likely to cause interference. This interference must be corrected at the expense of the user.

ATTENTION:

- The Twisted Pair Extension technology works with unshielded twisted pair (UTP) or shielded twisted pair (STP) cables; **but to ensure FCC Class A and CE compliance, STP cables and STP Connectors are required.**
- La technologie extension paires torsadées fonctionne avec les câbles paires torsadées blindées (UTP) ou non blindées (STP). Afin de s'assurer de la compatibilité entre FCC Classe A et CE, les câbles STP et les connecteurs STP sont nécessaires.

NOTES:

- (This 1st paragraph is for TP ONLY, delete for all others products) This unit was tested with shielded I/O cables on the peripheral devices. Shielded cables must be used to ensure compliance with FCC emissions limits.
- (if only this paragraph is used, reformat to single NOTE format.) For more information on safety guidelines, regulatory compliances, EMI/EMF compatibility, accessibility, and related topics, see the [Extron Safety and Regulatory Compliance Guide](#) on the Extron website.

VCCI-A Notice

この装置は、クラスA 情報技術装置です。この装置を家庭環境で使用すると、電波妨害を引き起こすことがあります。その場合には使用者が適切な対策を講ずるよう要求されることがあります。

VCCI-A

Battery Notice

This product contains a battery. **Do not open the unit to replace the battery.** If the battery needs replacing, return the entire unit to Extron (for the correct address, see the Extron Warranty section on the last page of this guide).

CAUTION: Risk of explosion. Do not replace the battery with an incorrect type. Dispose of used batteries according to the instructions.

ATTENTION : Risque d'explosion. Ne pas remplacer la pile par le mauvais type de pile. Débarrassez-vous des piles usagées selon le mode d'emploi.

Conventions Used in this Guide

Notifications

The following notifications are used in this guide:

 **WARNING:** Potential risk of severe injury or death.
AVERTISSEMENT : Risque potentiel de blessure grave ou de mort.

CAUTION: Risk of minor personal injury.
ATTENTION : Risque de blessure mineure.

ATTENTION:

- Risk of property damage.
- Risque de dommages matériels.

NOTE: A note draws attention to important information.

TIP: A tip provides a suggestion to make working with the application easier.

Software Commands

Commands are written in the fonts shown here:

```
^AR Merge Scene, ,0p1 scene 1,1 ^B 51 ^W^C.0  
[01] R000400300004000080000600 [02] 35 [17] [03]  
[Esc][X1]*[X17]*[X20]*[X23]*[X21]CE←
```

NOTE: For commands and examples of computer or device responses used in this guide, the character “0” is the number zero and “O” is the capital letter “o.”

Computer responses and directory paths that do not have variables are written in the font shown here:

```
Reply from 208.132.180.48: bytes=32 times=2ms TTL=32  
C:\Program Files\Extron
```

Variables are written in slanted form as shown here:

```
ping xxx.xxx.xxx.xxx -t  
SOH R Data STX Command ETB ETX
```

Selectable items, such as menu names, menu options, buttons, tabs, and field names are written in the font shown here:

```
From the File menu, select New.  
Click the OK button.
```

Specifications Availability

Product specifications are available on the Extron website, www.extron.com.

Extron Glossary of Terms

A glossary of terms is available at <http://www.extron.com/technology/glossary.aspx>.



Contents

Introduction..... 3

About this Guide.....	3
About the Quantum Videowall Processors.....	3
Models.....	4
Features.....	4
Functional Overview.....	7
RAPT Bus for Source Transfer.....	7
Display Architecture.....	9
Scenario Examples.....	10
Application Diagrams.....	16

Installation and Maintenance 20

Installation Steps.....	20
Rear Panel Features.....	22
Quantum Elite 615 Rear Panel.....	22
Quantum Elite 408 and Quantum Connect Rear Panels.....	24
Card Connections and Functions.....	26
Control Card.....	26
Input Cards.....	28
Output Cards.....	41
Input and Output Card Arrangements.....	47
Keyboard, Mouse, Monitor, USB, and Media Cards.....	48
Ethernet Connections.....	53
Front Panel Features.....	54
Quantum Elite 615 Front Panels.....	54
Quantum Elite 408 and Quantum Connect Front Panels.....	57
Maintenance.....	59
Cleaning Ventilation Grilles and Filters.....	59
Removing and Replacing Components.....	59

Operation..... 61

Powering On and Off.....	61
Using the Control Panel.....	63
Starting the Control Panel.....	63
Control Panel Buttons.....	64
Loading Image Files (Quantum Elite Models Only).....	64
Changing Network Settings.....	65
Updating Firmware.....	65
Shutting Down Using the Control Panel.....	68
Committing the Current Settings to Flash Memory.....	68
Accessing the Quantum Control Software.....	69
Computer System Requirements.....	69
Installing the Software.....	69
Starting the Software.....	70

QC 101 Controller..... 71

Overview of the QC 101.....	71
Installation and Connections.....	72
QC 101 Rear Panel Connections.....	72
Installation Overview.....	73
Connectivity Options.....	73
Connecting for RS-232 Control.....	74
Configuring the QC 101.....	75
Setting the QC 101 IP Address.....	75
Configuring the RS-232 Connection.....	78
Front Panel Indicators.....	79

Reference Information	80
Mounting	80
UL Guidelines for Rack Mounting.....	80
Rack Mounting the Quantum Processor	81
Mounting the QC 101	82
Network Setup	83
What is an IP Address?.....	83
Choosing IP Addresses	83
Subnet Mask	84
Pinging for the IP Address	84
Subnetting, a Primer	85

Introduction

This section gives an overview of the Extron Quantum Videowall Processors, describes significant features of the series, and provides sample application diagrams. The following topics are covered:

- [About this Guide](#)
- [About the Quantum Videowall Processors](#)
- [Features](#)
- [Functional Overview](#)
- [Application Diagrams](#)

About this Guide

This guide discusses how to install, configure, and operate the Quantum Elite and Quantum Connect videowall processors.

Throughout this guide, the terms “Quantum” and “processor” are used interchangeably to refer to both Quantum Elite models and the Quantum Connect.

About the Quantum Videowall Processors

The Quantum Elite 615, Quantum Elite 408, the Quantum Connect 82, and the Quantum Connect 84 are multi-window scalable and expandable videowall processors that can be configured for a variety of input, output, and window capabilities. These processors feature high performance video scaling technology that produces very high quality images. The Elite models can be populated at the factory with any combination of DVI-I or HDMI output cards, each of which supports up to 128 video graphic source windows, and with input cards for composite or S-video, RGB or HD component video, HDMI, DVI, and SDI (including 3G-SDI, HD-SDI, and SD-SDI) sources. The two Quantum Connect models are available with only HDMI input and output cards.

NOTES:

- Input capacity is based on an input-output card configuration with one slot occupied by an output card.
- Output capacity is based on an input-output card configuration with one slot occupied by an input card.

You can preprogram or create a variety of display scenarios as needed using the Quantum Elite or the Quantum Connect control software interfaces for setup and system operation. Many source signals can be shown at small sizes, a few at large sizes, or many combinations of both. The Quantum high performance image scaling technology accurately preserves the original image quality at all window sizes.

Models

Quantum Elite

- The **Quantum Elite 615** has a 6U high, 15-slot card frame. It has a maximum input capacity of 28 single-link DVI-D, 28 HDMI, 28 SDI, 28 RGB or HD component video, or 168 composite or S-video. Maximum output capacity is 28 DVI-I or HDMI. Multiple Quantum Elite 615 card cages can be used to create very large display arrays.
- The **Quantum Elite 408** has a 4U high, 8-slot card frame with a maximum input capacity of 14 single-link DVI-D, 14 HDMI, 14 SDI, 14 RGB or HD component video, or 84 composite or S-video. Maximum output capacity is 14 DVI-I or HDMI.

Additional DVI, HDMI, SDI, or RGB source signals can be streamed over an IP network to the Elite processors using the Extron QGE 100 IP encoder.

Quantum Connect

The **Quantum Connect 82 and 84** models have 4U high, eight-slot card frames with four HDMI input cards (eight HDMI inputs).

The Quantum Connect is ideal for small to medium videowalls with 2 to 14 screens. Two models are available:

- **Connect 82** is configured with one HDMI output card (two HDMI outputs per card).
- **Connect 84** is configured with two HDMI output cards (four HDMI outputs per card).

NOTE: The Connect models do **not** support the following features that are provided on the Elite models:

- Input and output cards other than HDMI
- Customized configurations to order
- QGE 100 source types
- Picture and image file source types
- Window borders or text
- Clock and timer source types
- Multiple processor systems
- Edge-blended displays

Features

- **Card frame videowall processing system** — The Quantum processor allows for various combinations of input and output cards to match specific source and videowall configurations. It is a fully modular system, allowing each unit to be individually configured to best suit the end user application.
- **Input configurations** — The Quantum processor can be configured with various combinations of inputs within the available card slots.

All models:

- **HDMI input:** The dual HDMI/DVI input card accepts two HDMI or DVI sources at resolutions up to 1920x1200 and HDTV 1080 @ 60 Hz, as well as custom resolutions.

NOTE: Appropriate HDMI to DVI cables or adapters are required for DVI signal input on this card.

Quantum Elite:

- **DVI input:** The dual DVI-D input card accepts two digital or analog DVI sources at resolutions up to 1920x1200 and HDTV 1080p @ 60 Hz as well as custom resolutions.
- **SDI input:** The dual SDI input card accepts two 3G-SDI, HD-SDI, or SD-SDI sources in any combination at 480i, 576i, 720p, 1080i, and 1080p resolutions.
- **High-resolution analog input:** The RGB or YPrPb dual input card accepts RGB graphic and HD component video signals at resolutions up to 1920x1200 and HDTV 1080p @ 60 Hz, as well as custom resolutions.
- **Composite video and S-video input:** The 12-channel standard definition video input card accepts up to 12 composite or S-video sources in any combination.
- **Output** — Each output supports rates from 640x480 (VGA) to 1920x1200 and HDTV 1080p @ 60 Hz.
- **HDMI output:** The dual HDMI output card includes two HDMI outputs for HDMI or DVI video connection to two displays in the videowall.

NOTE: Appropriate HDMI to DVI cables or adapters are required for DVI signal output on this card.

- **DVI output (Quantum Elite only):** The dual DVI/RGB output card includes two DVI-I outputs for digital or analog video connection to two displays in the videowall.
- **Scalable and expandable configuration (Quantum Elite only)** — The Quantum Elite systems are scalable and can be expanded with additional input or output cards or by cascading card frames together for a larger videowall or additional input sources.
- **HDCP-compliant input/output options** — HDCP-encrypted content can be displayed on HDCP-compatible displays when Quantum HDMI input and output cards are used.
- **HDCP Visual Confirmation signal** — A green window with an alert message is displayed when HDCP-encrypted content is transmitted to a non-HDCP compliant display, providing immediate visual confirmation that protected content cannot be viewed on the display.
- **Key Minder HDCP compliance verification** — Key Minder authenticates and maintains continuous HDCP encryption between input and output devices to ensure quick and proper display of HDCP-encrypted source signals on the videowall.
- **Up to 128 video or graphic windows per dual output card** — Extensive windowing capabilities include the ability to display up to 128 windows of video and graphics for each pair of displays in the videowall.
- **IP streaming of hundreds of RGB, HDMI, or DVI inputs (Quantum Elite only)** — In addition to the input cards, additional DVI or RGB graphics sources can be streamed over an IP network to the Quantum Elite, using the optional Extron QGE 100 Quantum Graphics Encoders.
- **Upload and display stored images** — JPEG, GIF, PNG, and BMP image files can be uploaded to the Quantum and displayed within the windows or used as backgrounds behind them.
- **High speed RAPT bus** — The dedicated high speed 10 Gbps video and graphic Real-time Asymmetric Packetized Transfer (RAPT) bus enables large numbers of high resolution input signals to be processed simultaneously while preserving real time control response and optimal image quality at full frame rates.

- **Image up-scaling and down-scaling** — High performance image scaling technology provides high quality up-scaling and down-scaling of high resolution RGB or HD video signals.
- **Solid state flash storage (Quantum Elite 615 only)** — The Quantum Elite 615 model features CompactFlash-based data storage for the operating system and image files. This avoids the need for a hard disk drive and delivers continuous system operation and enhanced reliability. Write-protected flash storage eliminates the risk of virus retention and allows for easy removal of data in secure environments.
- **Quantum Control Software** — The Quantum Elite Control Software and the Quantum Connect Control Software are Microsoft® Windows®-based applications that run on your computer and control the Quantum processors.

This software enables the Quantum to output multiple source signals to a display.

NOTE: Each Quantum model has its own control program. The Quantum Elite Control Software cannot be used with Quantum Connect and vice versa.

- **EDID Minder** — The Extron EDID Minder automatically manages the Extended Display Identification Data (EDID) for all the input sources. By default, input EDIDs match the current output resolution of the processor. Also available is a user assigned mode, which allows pre-stored EDIDs, based on user selected resolutions, to be manually assigned to the sources. By maintaining continuous EDID communication with all sources, EDID Minder ensures that all sources power up properly and maintain their video outputs whether or not they are actively connected to the display device through the Quantum outputs.

Using the Quantum Control Software you can set the EDID properties for each of the inputs installed in your Quantum card frame as well as view the current EDID that has been set for each input.

- **Quantum Control Panel** — The Quantum processor is a host device with Microsoft Windows XP embedded. The Quantum Control Panel is a Windows-based program that is resident on the Quantum internal disk or flash drive and enables you to perform various setup tasks, such as setting the processor IP address or updating its firmware. To view the Control Panel screens, attach a PS/2 or USB keyboard and mouse and a monitor to the appropriate connectors on the rear panel.
- **QC 101 Controller (optional)** — The QC 101 C (for the Quantum Connect) and the QC 101 E (for the Quantum Elite models) are optional controllers with embedded operating systems. These controllers attach to a control system (such as the Extron IPCP or IPL Pro via RS-232) and to the Quantum via Ethernet. The QC 101 C connects to one Quantum Connect chassis, while the QC 101 E can connect to up to eight Quantum Elite chassis via an Ethernet switch. The QC 101 controllers are delivered with the Quantum Control Software loaded and can be used to create and store configuration projects for the Quantum processors.
- **Redundant, hot-swappable fans** — An individual fan can be removed without powering down the processor. The optimized cooling system requires no additional rack space for ventilation.
- **Redundant, hot-swappable power supplies (Quantum Elite 615 only)** — Either of two individual power supplies can be removed and replaced without the need to power down the processor.
- **Reliability** — Content from connected video sources continues to display if a system crash occurs. The system returns to its previous operational state when rebooted.
- **Ethernet communication** — An Ethernet port provides system control and operation from a computer with the Quantum Control Software loaded.

- **USB port** — Two USB ports are provided to access image files on a USB flash drive or to connect a USB keyboard and mouse to access the Quantum Control Panel.
- **Motion adaptive deinterlacing** — The SDI input card provides motion adaptive deinterlacing for NTSC, PAL, and 1080i input signals. Film mode detection is provided to properly deinterlace content originating from film.

Functional Overview

The Quantum can display a large number of sources in real time on a target display. This section gives an overview of the features and functions that can affect the system performance. The following key factors can affect system capabilities:

- **Number of input and output card slots** — The number of input and output cards determines how many video inputs and display outputs are available. The Quantum Elite 615 card frame can accommodate up to 15 cards, while the Quantum Elite 408 can have up to 8 cards. The Quantum Connect has 4 input cards and 1 (Connect 82) or 2 (Connect 84) output cards.
- **RAPT bandwidth** — The RAPT (Real-time Asymmetric Packetized Transfer) bus carries video and RGB source data between the input and output cards. It can carry the equivalent of 48 full-resolution standard definition video sources in real time. If more data needs to be transported, a scheme of bandwidth management is implemented.
- **Rectangulation limit** — The maximum number of windows that can be displayed by a single output card is 128 rectangles per output channel pair (windows can be displayed on one or both channels).

RAPT Bus for Source Transfer

The RAPT is a high-speed data bus used exclusively for the transfer of digitized video and RGB source data between the input and output cards. It is also used to carry any QGE 100 source signals to the output cards.

Real time performance

The RAPT bus delivers data in real time. This means that it is able to display a source at its full temporal resolution, maintaining the same scan rate as the original source without dropping any fields or frames. The RAPT bus remains operational if an operating system crash occurs, allowing crucial source content to be maintained on the target display. The RAPT bus can carry the equivalent of 48 full-resolution, full-motion standard definition video sources in real time, using 4:2:2 sampling and single-field deinterlacing, as summarized in the [table](#) on the next page.

Source Type	Sampling	Deinterlacing	Maximum Number of Real Time Sources	
			At 50 Hz	At 60 Hz
NTSC	4:2:2	Single field	–	48
		Three field	–	24
PAL/SECAM	4:2:2	Single field	48	–
		Three field	24	–
HD 1080i	4:4:4	Single field	8	6
		Three field	4	3
HD 1080p	4:4:4	n/a	4	3
HD 720p	4:4:4	n/a	9	7
UXGA	4:4:4	n/a	4	3
SXGA+	4:4:4	n/a	5	4
SXGA	4:4:4	n/a	6	5
WXGA	4:4:4	n/a	8	7
XGA	4:4:4	n/a	10	8
SVGA	4:4:4	n/a	17	14

Optimizing the number of displayed sources

The maximum number of sources that can be displayed can be significantly increased if you display them at less than their native spatial resolution. For example, if sources are displayed at one quarter of their native spatial resolution, the RAPT bus can accommodate four times as many sources while preserving full temporal resolution.

Low resolution sources

Source Format		Maximum Number of Real Time Sources
Resolution	Deinterlacing	
NTSC	Single field	–
	Three field	–
Full native resolution: NTSC (720x480) PAL/SECAM (720x576)	Single field	48
	Three field	24
Quarter resolution: NTSC (360x240) PAL/SECAM (360x288)	Single field	192*
	Three field	96

* A maximum of 156 sources can be viewed simultaneously by using 13 input cards and 2 output cards.

High-definition sources

Resolution		Maximum Number of Real Time Sources
HD 720p	Full native	7
	Quarter	28
HD 1080p	Full native	3
	Quarter	12

Display Architecture

When Quantum is controlled by the Quantum Control Software, source signals are placed on the display in windows, which are fully resizable and can be positioned anywhere on the displays.

NOTES:

- The Quantum Control Software remembers the display layout that was in effect before the system was powered down.
- By default, each new Quantum system is configured with a single, full-size window that is displayed with a Quantum logo design. This logo is stored on the internal flash drive or hard disk.
- For further details on controlling source window content, size, and positioning, see the *Quantum Control Software User Guide*.

Source layers

The output image has two layers:

- **PCI source layer** — Used to display source signals delivered via the PCI bus, such as stored images and window border attributes
- **RAPT source layer** — Used to display source signals delivered via the RAPT bus, that is, digitized sources from the input cards and QGE 100 sources

When no source windows are present, the PCI source layer is black and the RAPT source layer fully transparent, making the entire display appear black.

The layer on which source windows are placed is determined by the Quantum processor and control software, and needs no user intervention.

Rectangulation Limit (RAPT Source Layer)

There is no limit to the number of source windows that can be placed on the PCI source layer. However, the maximum number of windows that can be displayed at one time on the RAPT source layer is dependent on a **rectangulation limit**, which is the maximum number of rectangles needed to draw the display layout.

For example, the following display layouts both use two windows, but note the different number of rectangles used to draw each layout:



Figure 1. Rectangulation Example

In the example above, you can see that the most efficient display layout (using the fewest rectangles) is for the source windows to be displayed as an array, with no gaps or overlaps.

The output card supports layouts that require a maximum of 128 rectangles in total, shared between both output channels; for example, 64 on each channel or 128 on one channel.

Therefore, up to 128 video, RGB, DVI, HDMI, and QGE 100 sources can be displayed on a single screen if the rectangulation limit is not exceeded.

Scenario Examples

The following scenario examples illustrate various applications that might be required on a site. For each scenario, the effect on the number of card slots, the RAPT bandwidth, and the rectangulation limit is shown using three bar graphs.

Wherever possible, the layout examples show source windows at their normal aspect ratio. Some windows are shown stretched horizontally or vertically to make optimum use of the display space. RAPT bandwidth and rectangulation usage are based on the window layout shown. Window layouts can be changed to suit specific applications, but different layouts alter the given usage values.

Scenario 1 – Maximum number of video sources on a single screen

Screen layout – Scenario 1

In this scenario, a single 1600x1200 display device displays 128 video source windows.

1	2	3	4	5	6	7	8	9	10	11	12
13	14	15	16	17	18	19	20	21	22	23	24
25	26	27	28	29	30	31	32	33	34	35	36
37	38	39	40	41	42	43	44	45	46	47	48
49	50	51	52	53	54	55	56	57	58	59	60
61	62	63	64	65	66	67	68	69	70	71	72
73	74	75	76	77	78	79	80	81	82	83	84
85	86	87	88	89	90	91	92	93	94	95	96
97	98	99	100	101	102	103	104	105	106	107	108
109	110	111	112	113	114	115	116	117	118	119	120
121	122	123	124	125	126	127	128				

Figure 2. Example of a Single 1600x1200 Display Showing the Maximum Number of Windows Possible on One Screen

Because each window is smaller than the native source resolution, the input card scales each source down to the required size. This greatly reduces the amount of source data transferred across the RAPT bus to the output card and allows a large number of sources to be displayed simultaneously in real time.

Hardware requirements – Scenario 1

The hardware requirements for scenario 1, 128 inputs displayed on one screen, are:

- 1 output card (Only one output channel is used to drive a single 1600x1200 screen.)
- 11 input cards, providing 132 source inputs. (Only 128 can be viewed simultaneously.)
- A Quantum Elite 615 (15-card) card frame

System capacity – Scenario 1

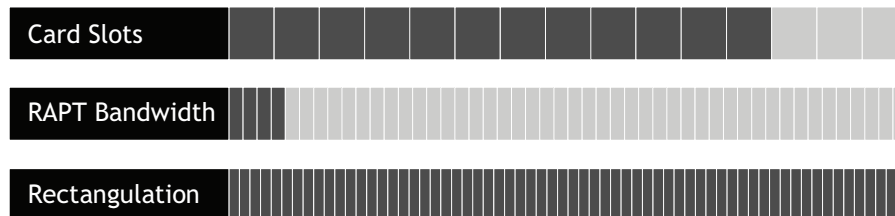

Figure 3. System Capacity for Scenario 1

The limit of 128 source windows is imposed by the rectangulation limit of the output card. All sources are displayed in real time.

RAPT bandwidth usage assumes that all sources are using single-field deinterlacing. Using three-field deinterlacing doubles the amount of source data without exceeding the real time RAPT limit.

Expansion Options – Scenario 1

On the Quantum Elite 615, you have three spare card slots to which you can add more input cards, increasing the choice of sources. Alternatively, you can add output cards to spread out the windows and increase their size.

Scenario 2 – Maximum number of full resolution video sources on a tiled display

Screen layout – Scenario 2

In this scenario, 12 UXGA (1600x1200) displays create a 4x3 tiled display with 48 video source windows arranged in an 8x6 array. The total display size is 6400x3600 pixels, making each window 800x600 pixels.

1	2	3	4	5	6	7	8
9	10	11	12	13	14	15	16
17	18	19	20	21	22	23	24
25	26	27	28	29	30	31	32
33	34	35	36	37	38	39	40
41	42	43	44	45	46	47	48

Figure 4. Example of Tiled Full Resolution Video Sources on a Tiled Display

Because each window is larger than the native source resolution, each source is transferred across the RAPT bus at its native resolution and then scaled up to the required size by the output card.

Hardware requirements – Scenario 2

The hardware requirements for scenario 2, video sources on a 4x3 tiled display, are:

- 6 output cards (driving 12 UXGA screens)
- 4 input cards (providing 48 source inputs)
- A Quantum Elite 615 card frame

System capacity – Scenario 2

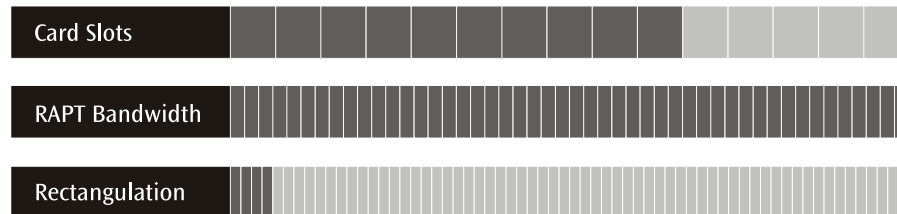

Figure 5. System Capacity for Scenario 2

The limit of 48 real time source windows is imposed by the available RAPT bandwidth and the available screen space. This assumes that all sources are using single-field deinterlacing.

Expansion options – Scenario 2

With the Quantum Elite 615, you have five spare card slots to which you can add more output cards to provide more screens, or you can add more input cards to increase the choice of sources.

NOTE: Increasing the number of full resolution source windows exceeds the real time limit of the RAPT bus, so the Quantum uses its bandwidth management scheme.

Scenario 3 – Maximum number of video sources on a tiled display

Screen layout – Scenario 3

In this scenario, six UXGA (1600x1200) display devices create a 3x2 tiled display of 144 video source windows arranged in a 12x12 array. The total display size is 4800x2400 pixels, making each window approximately 133x100 pixels.

1	2	3	4	5	6	7	8	9	10	11	12
13	14	15	16	17	18	19	20	21	22	23	24
25	26	27	28	29	30	31	32	33	34	35	36
37	38	39	40	41	42	43	44	45	46	47	48
49	50	51	52	53	54	55	56	57	58	59	60
61	62	63	64	65	66	67	68	69	70	71	72
73	74	75	76	77	78	79	80	81	82	83	84
85	86	87	88	89	90	91	92	93	94	95	96
97	98	99	100	101	102	103	104	105	106	107	108
109	110	111	112	113	114	115	116	117	118	119	120
121	122	123	124	125	126	127	128	129	130	131	132
133	134	135	136	137	138	139	140	141	142	143	144

Figure 6. Example of the Maximum Number of Video Sources on a Tiled Display

Because each window is smaller than the native source resolution, the input card scales each source down to the required size. This greatly reduces the amount of source data to be transferred across the RAPT bus to the output card, allowing a large number of sources to be displayed simultaneously in real time.

Hardware requirements – Scenario 3

- 3 output cards driving 6 UXGA screens
- 12 input cards providing 144 inputs
- A Quantum Elite 615 card frame

System capacity – Scenario 3

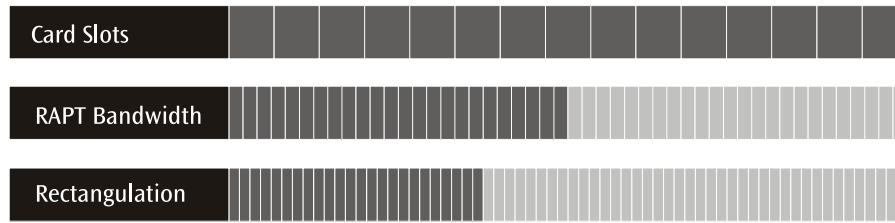

Figure 7. System Capacity for Scenario 3

The limit of 144 real time video source windows is imposed by the maximum number of card slots being used.

Expansion options – Scenario 3

Assuming that all video sources are using single-field deinterlacing, approximately 50 percent of the RAPT bandwidth is being used. Rectangulation is also well below its limit, so there is plenty of room for adding RGB graphics (QGE 100) sources.

NOTE: A maximum of 25 QGE 100 sources can be displayed simultaneously by a Quantum processor at any time.

Scenario 4 – Maximum number of sources on the largest display

Screen layout – Scenario 4

In this scenario, eight UXGA displays create a 4x2 tiled display of 132 video source windows arranged in a 16x8 array. The total display size is 6400x2400 pixels, making each window 400x300 pixels.

1	2	3	4	5	6	7	8	9	10	11	12	13	14	15	16
17	18	19	20	21	22	23	24	25	26	27	28	29	30	31	32
33	34	35	36	37	38	39	40	41	42	43	44	45	46	47	48
49	50	51	52	53	54	55	56	57	58	59	60	61	62	63	64
65	66	67	68	69	70	71	72	73	74	75	76	77	78	79	80
81	82	83	84	85	86	87	88	89	90	91	92	93	94	95	96
97	98	99	100	101	102	103	104	105	106	107	108	109	110	111	112
113	114	115	116	117	118	119	120	121	122	123	124	125	126	127	128
129	130	131	132												

Figure 8. Example of the Maximum Video Sources on the Largest Display

Because each window is smaller than the native source resolution, the input card scales each source down to the required size. This greatly reduces the amount of source data to be transferred across the RAPT bus to the output card, allowing a large number of sources to be displayed simultaneously in real time.

Hardware requirements – Scenario 4

- 4 output cards driving 8 UXGA screens
- 11 input cards providing 132 source inputs
- A Quantum Elite 615 card frame.

System capacity – Scenario 4

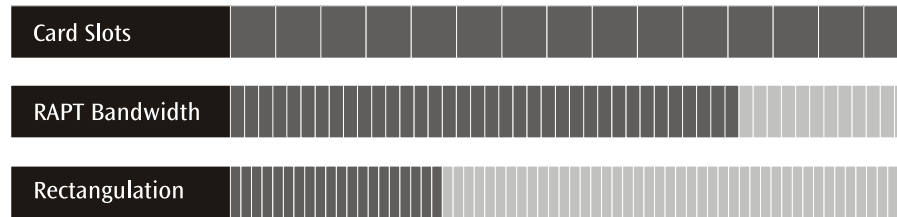

Figure 9. System Capacity for Scenario 4

The limit of 132 real time video source windows is imposed by the maximum number of card slots being used.

Expansion options – Scenario 4

Assuming that all video sources are using single-field deinterlacing, approximately 75 percent of the RAPT bandwidth is being used. Rectangulation is also well below its limit, so there is plenty of room for adding RGB graphics (QGE 100) sources.

NOTE: A maximum of 25 QGE 100 sources can be displayed simultaneously by a Quantum processor at any time.

Application Diagrams

The following application diagrams show examples of how the Quantum Connect and Quantum Elite can be connected.

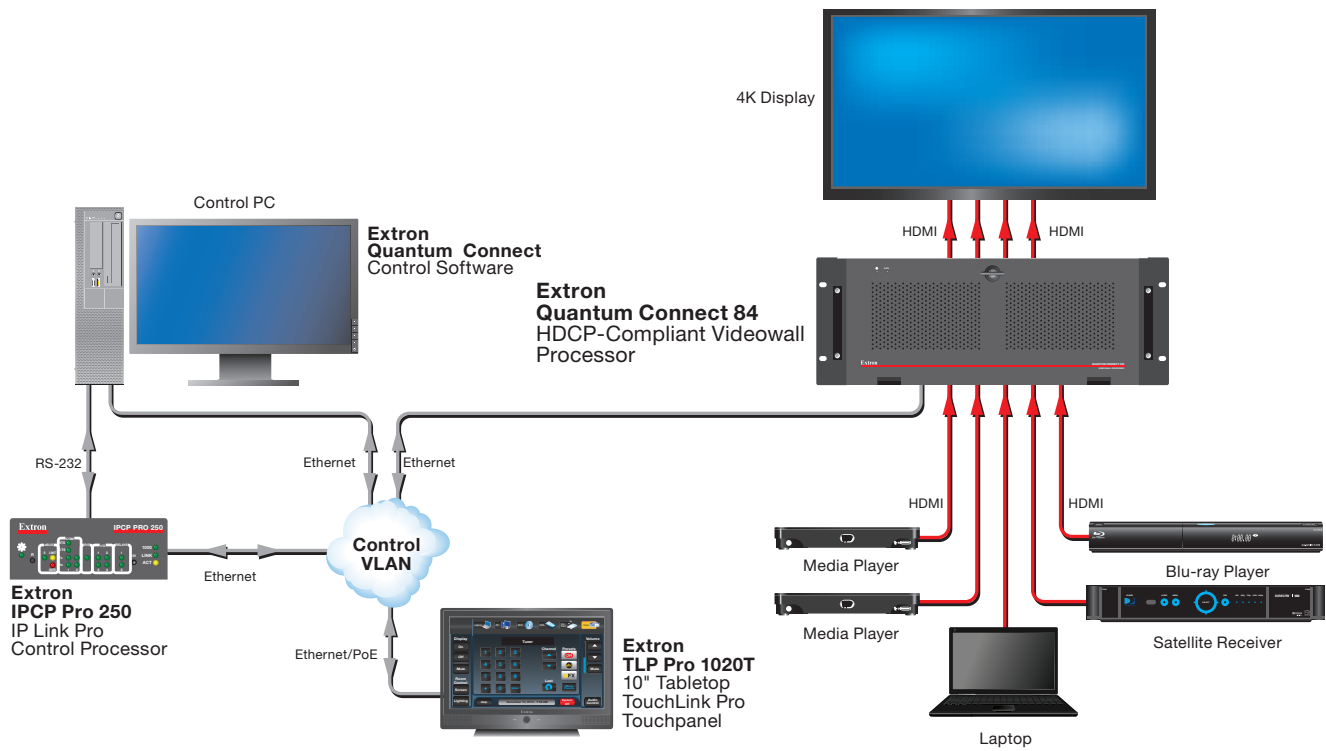

Figure 10. Connection Diagram for a Quantum Connect

NOTE: The Quantum Connect model does not support the use of the Media I and Media II network ports that are available on the Elite models.

HDCP-Compliant Displays

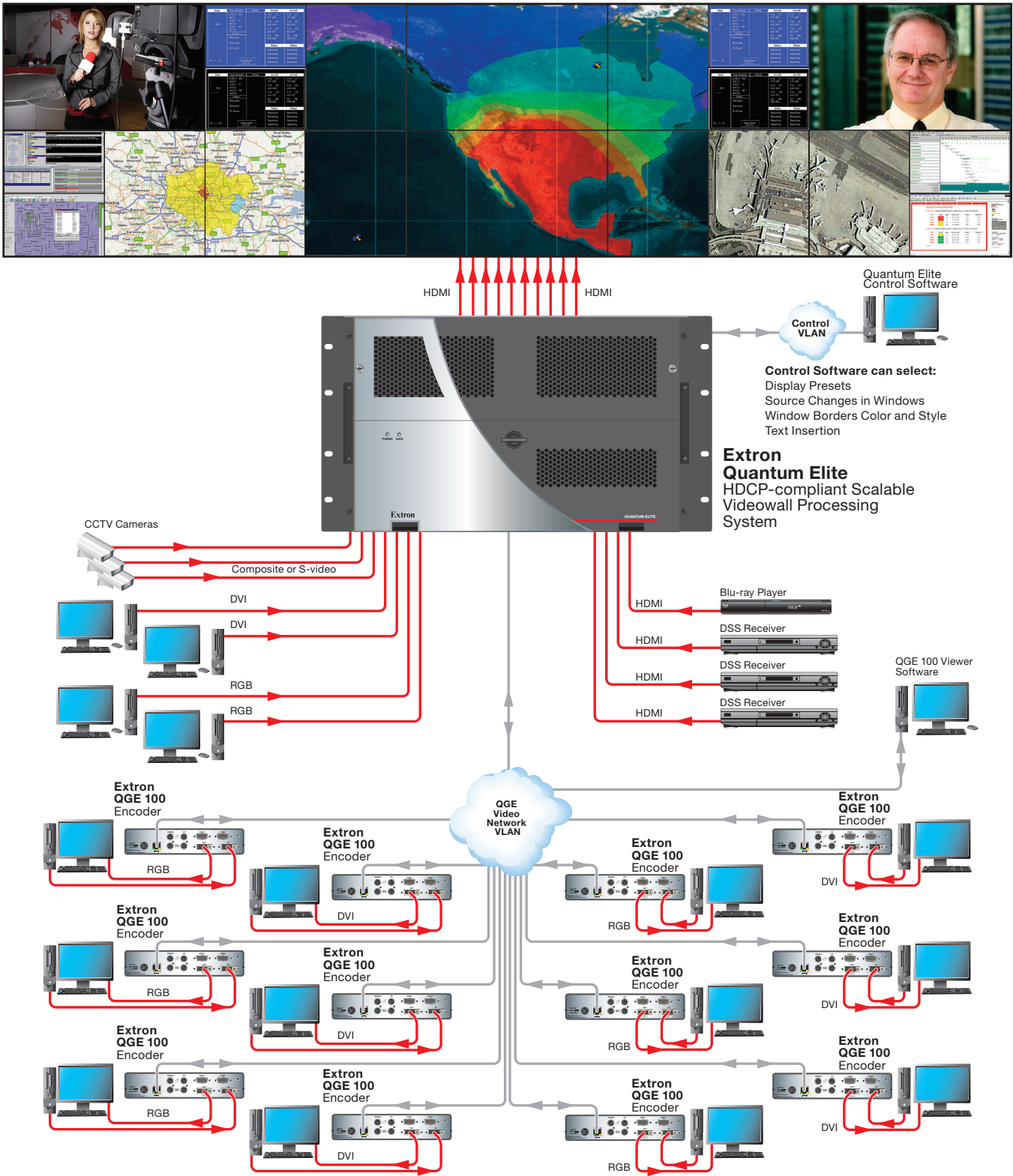

Figure 11. Connection Diagram for Quantum Elite 615

HDCP-Compliant Displays

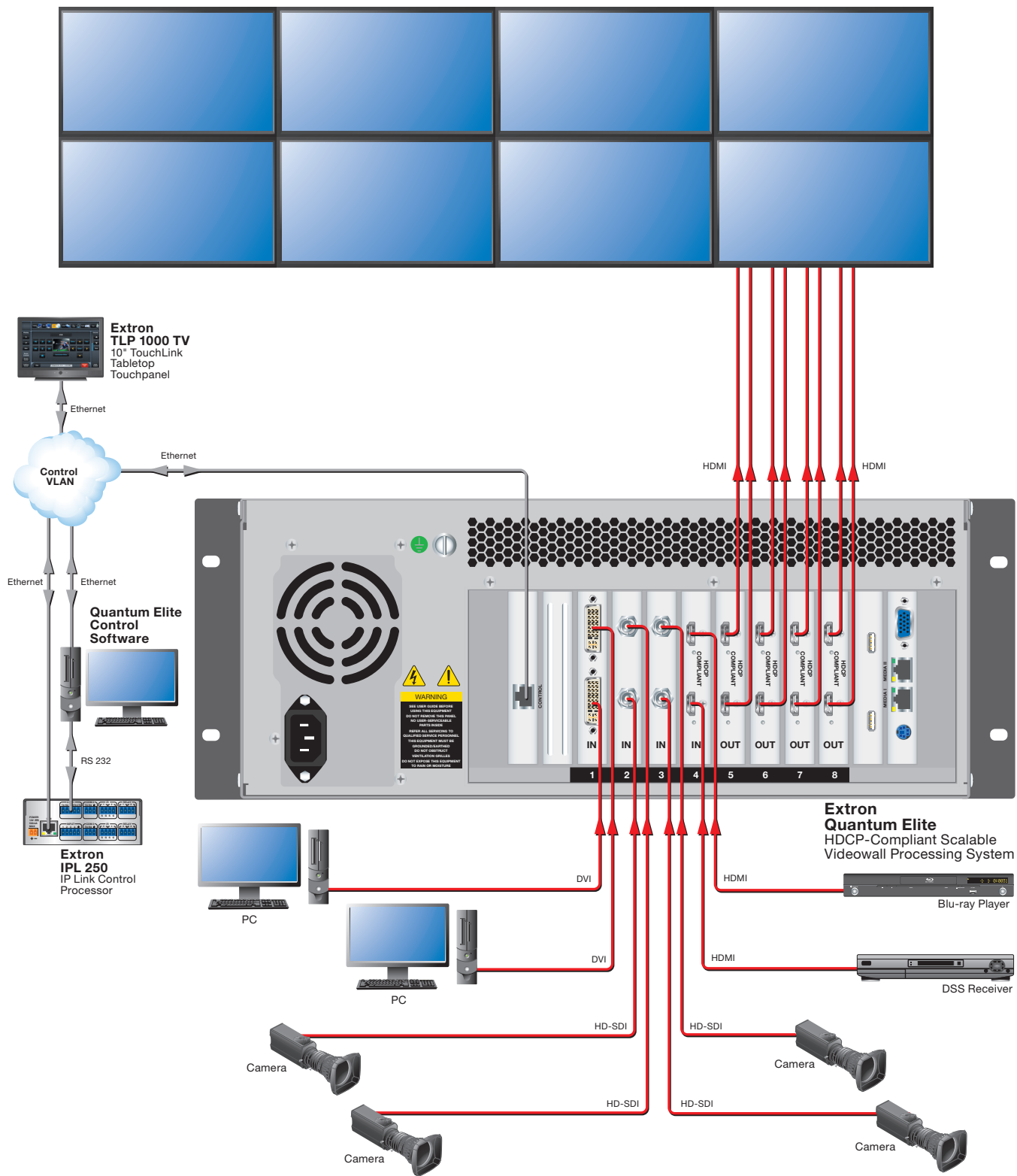

Figure 12. Connection Diagram for a Quantum Elite 408

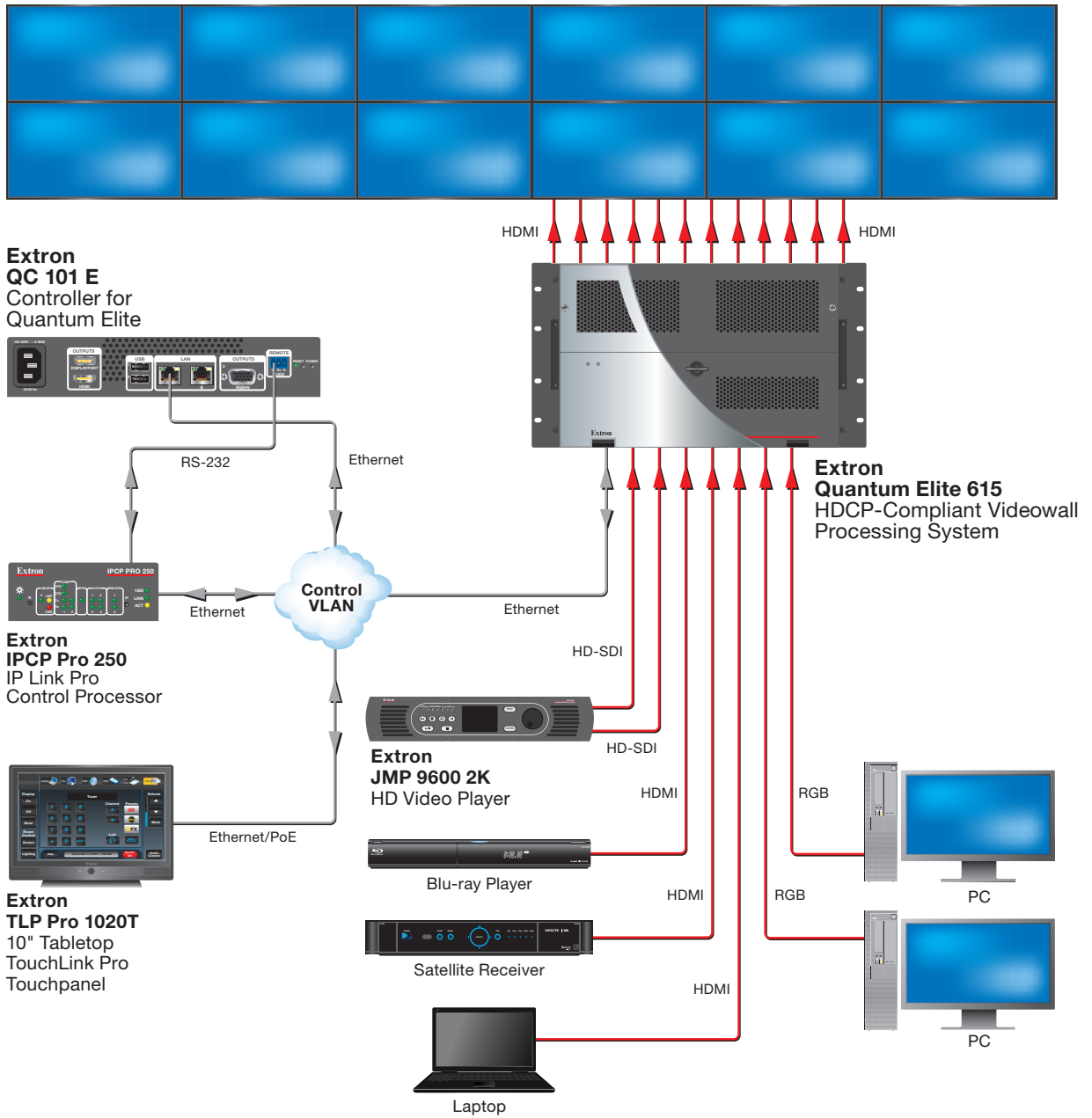

Figure 13. Connection Diagram for Quantum Elite with a QC 101 E Controller

Installation and Maintenance

This section provides the steps to install the Quantum processor. It also describes the rear panel components and provides instructions for cabling. The following topics are included:

- [Installation Steps](#)
- [Rear Panel Features](#)
- [Card Connections and Functions](#)
- [Ethernet Connections](#)
- [Front Panel Features](#)
- [Maintenance](#)

Installation Steps

The Quantum processor can be mounted in a 19-inch equipment rack or placed on a table or other furniture. To install and set up the Quantum processor for a videowall, follow the steps below (see the [application diagrams](#) starting on page 14 for connection examples).

1. Disconnect power from the processor and turn off all other equipment in the system.
2. If desired, mount the processor to a rack (see [Mounting](#) on page 78).
3. Make cable connections in any order between appropriate devices and the Quantum rear panel ports as needed:
 - Control Ethernet
 - DVI, RGB, HDMI, SDI, and video inputs
 - DVI and HDMI outputs

NOTE: With adapters, RGB is available on the DVI ports and DVI is available on the HDMI ports.

 - USB
 - Monitor
 - Keyboard and mouse
 - QC 101 controller (optional)
 - Media I and Media II Ethernet for QGE 100 video networks (Quantum Elite models only)
4. Connect power to the IEC connector.
5. Power on all connected devices.

6. Set the Quantum power switch or switches to On. (The power switches are on the front panel behind the access door. See [Front Panel Features](#), beginning on page 52.)

WARNING: To avoid the risk of electric shock or product damage due to condensation, always allow the Quantum processor to become acclimated to ambient temperature and humidity for at least 30 minutes before switching it on. This is particularly important when you are moving the unit from a cold to a warm location.

AVERTISSEMENT : Afin d'éviter un risque éventuel de choc électrique ou d'endommagement du Quantum dû à la condensation, laisser toujours le temps à la source d'alimentation de s'adapter à la température et à l'humidité ambiantes, pendant au moins 30 minutes, avant de les brancher. Ceci est particulièrement important lorsque vous déplacez l'unité depuis un lieu frais vers un lieu chaud.

7. (Optional) Configure the IP address using the Control Panel. The Quantum processor is a host device with a Windows XP operating system of which the Control Panel is a component. To view and use the Control Panel, you must have a keyboard, mouse, and monitor connected to the appropriate cards in the Quantum chassis (see [Keyboard, Mouse, Monitor, USB, and Media Cards](#) on page 46 for information on connecting these items. See [Using the Control Panel](#) on page 61 for information on this feature).
8. (Optional) Configure the IP address of the QC 101 Controller. This optional controller connects to a control system via RS-232 and to the Quantum processor via Ethernet. It has an embedded operating system and is provided with the Quantum Control Software. Attach a monitor, keyboard, and mouse to this controller to configure it. See [QC 101 Controller](#), beginning on page 69, for more information on this controller.
9. Install and set up the Quantum Control software on your computer (see the *Quantum Control Software User Guide*, available on the provided Quantum software CD). See [Installing the Software](#) on page 67 for information on obtaining and starting the Windows-based control software.
10. Use the Quantum Control Software to configure sources and displays for your videowall system (see the control program help file for the procedures).

NOTE: Steps 8 and 9 can be performed without the inputs, outputs, or any other hardware being connected to the Quantum.

Rear Panel Features

The Quantum rear panels provide slots for cards containing video input and output connectors, RJ-45 network connectors, connectors for a keyboard, mouse, and monitor, and USB connectors. It also contains the power connector and two vents.

Quantum Elite 615 Rear Panel

The Quantum Elite 615 rear panel has 15 slots in which cards can be installed to order, plus three slots in which cards are permanently installed. It also contains the main power connector and the vents.

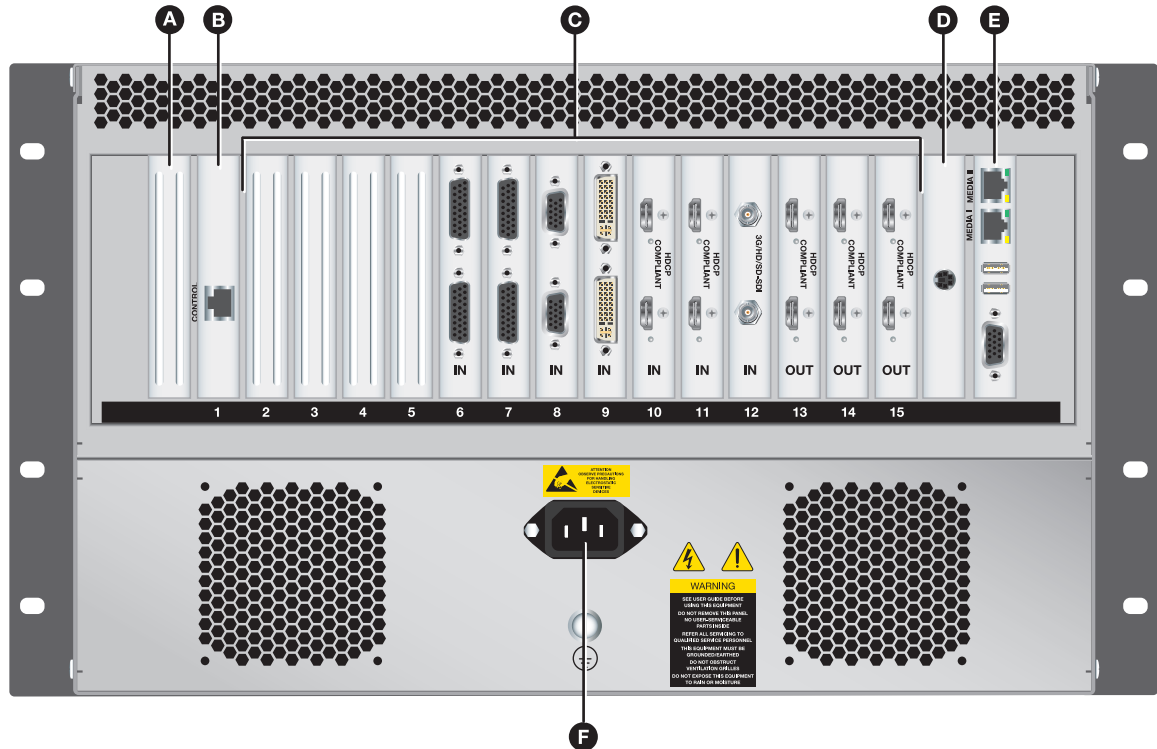

Figure 14. Quantum Elite 615 Rear Panel

- | | |
|---------------------------------|---|
| A Slot 0 | D PS/2 keyboard card |
| B Control card | E Media I and Media II network, USB, and monitor ports |
| C Input and output cards | F Power connector |

A Slot 0 — By default, this slot is empty. If all other input and output slots are full, an additional input card can be installed in this slot.

B Control card — This slot holds the card containing the Control port. To enable control via the Quantum Control Software, use this RJ-45 Ethernet connector (shown at right) to connect the Quantum to a network, a single computer, or a QC 101 controller. See **Control Card** on the next page, **Ethernet Connections** on page 51, and **QC 101 Controller**, beginning on page 69, for more information.



- **ACT LED** — The amber Activity LED blinks to indicate network activity.
- **LINK LED** — The green Link LED lights steadily to indicate a good network connection.

- C Input and output cards** — The slots numbered 2 through 15 on the rear panel contain input and output cards. When you order the Quantum, you specify the desired number and type of input cards and output cards. You receive the system with all cards installed.

On the Quantum Elite models, replacement card kits are available to order. These cards must be installed by a trained technician.

NOTE: The system must contain at least one input card and one output card.

Cards are installed in slots 15 through 2, from right to left, starting with slot 15, which must contain an output card (see [Input card locations](#) on page 26 and [Output card locations](#) on page 39 for more information on card placement).

- D PS/2 keyboard card** — Connect a PS/2 keyboard (provided with the unit) to the mini DIN connector when you need to perform basic system setup or troubleshooting using the Control Panel (see [Using the Control Panel](#) on page 61).
- E Media I and Media II network, USB, and monitor ports** — On the Quantum Elite 615, the following ports are contained on this card:
- **Media I and II network ports:** These two 2 gigabit Ethernet (1000Base-T) ports can be used to connect the Quantum Elite 615 to external local area networks (LANs) or wide area networks (WANs) to access remote Quantum QGE 100 sources. Connect Category (CAT) 5 STP patch cables between these RJ-45 connectors and the network.
 - **USB ports:** Connect optional USB storage devices to these USB type A ports to enable loading of image files or software upgrades. A USB keyboard and mouse also can be attached to these ports to provide access to the Control Panel. (A USB mouse is provided with the unit.)
 - **Monitor port:** Connect an optional monitor to this 15-pin VGA connector to enable viewing of internal settings during basic setup, servicing, and fault diagnostic procedures. This port is not used for normal operation.
- F Power connector** — Connect the supplied IEC power cord between this male IEC connector and an AC power source. (A power switch on the front panel powers the unit on and off.)

Quantum Elite 408 and Quantum Connect Rear Panels

The Quantum Elite 408 and Quantum Connect 84 and 82 rear panels have 11 slots in which cards are installed:

- **Quantum Elite 408** — Has eight slots in which cards can be installed to order, plus three slots in which cards are permanently installed. The rear panel also contains the power connector and vents.
- **Quantum Connect 82 and 84** — Have eight slots that contain HDMI input and output cards. Connect 84 has four HDMI input cards and two HDMI output cards. Connect 82 has four input cards and one output card.

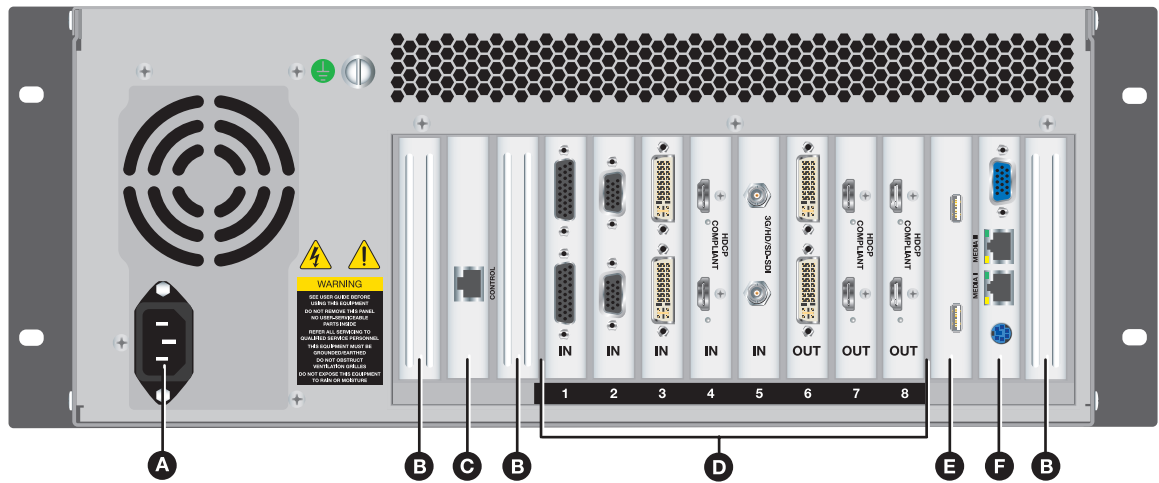

Figure 15. Quantum Elite 408 Rear Panel

- | | |
|--------------------------|--|
| A Power connector | D Input and output cards |
| B Unused slots | E USB card |
| C Control card | F Monitor, Media I and Media II network, and keyboard and mouse ports |

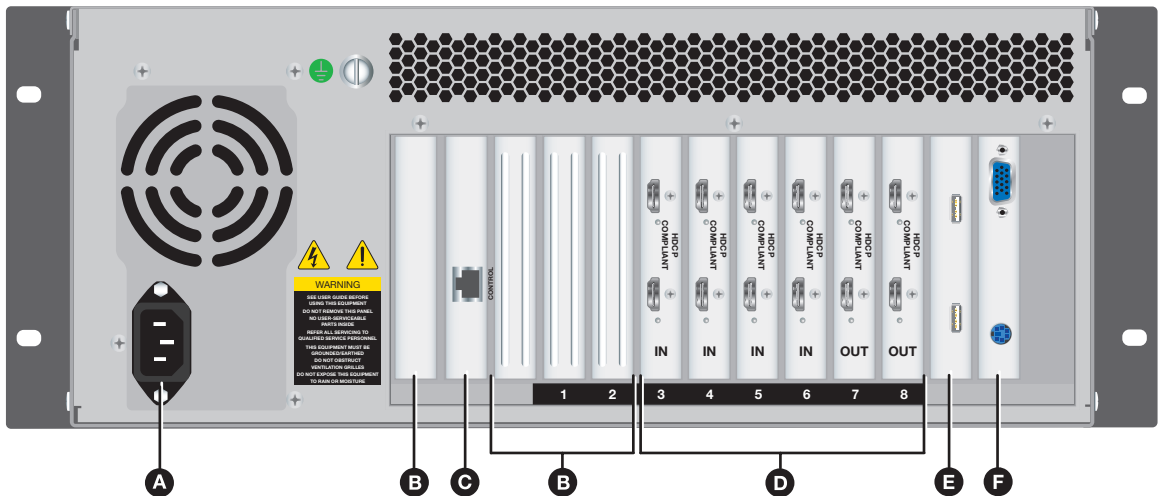

Figure 16. Quantum Connect 84 Rear Panel

- | | |
|--------------------------|--------------------------------------|
| A Power connector | D HDMI input and output cards |
| B Unused slots | E USB card |
| C Control card | F Keyboard and mouse ports |

A Power connector — Connect the supplied IEC power cord between this male IEC connector and an AC power source. (A power switch on the front panel powers the unit on and off.)

B Unused slots — No cards are installed in these slots.

C Control card — This slot holds the card containing the Control port. To enable control via the Quantum Control Software, use this RJ-45 Ethernet connector (shown at right) to connect the Quantum to a network, a single computer, or a QC 101 controller. See **Control Card** on the next page, **Ethernet Connections** on page 51, and **QC 101 Controller**, beginning on page 69, for more information.



- **Act LED** — The amber Activity LED blinks to indicate network activity.
- **Link LED** — The green Link LED lights steadily with a good network connection.

D Input and output cards — The slots numbered 1 through 8 on the rear panel contain input and output cards.

- **Quantum Elite** — When you order a Quantum Elite, you specify the desired number and type of input cards and output cards. You receive the system with all cards installed.

On the Quantum Elite models, replacement card kits are available to order. These cards must be installed by a trained technician.

NOTE: The system must contain at least one input card and one output card.

Cards are installed in slots 8 through 1, from right to left, starting with slot 8, which must contain an output card (see **Input card locations** on page 26 and **Output card locations** on page 39 for more information on card placement).

- **Quantum Connect 82 and 84** — Each of these models is available in only one configuration. Connect 84 has four HDMI input cards, installed in slots 3 through 6, and two HDMI output cards, installed in slots 7 and 8. Connect 82 has four HDMI input cards, installed in slots 4 through 7, and one output card, installed in slot 8.

E USB card — Connect optional USB storage devices to these USB type A ports to enable loading of image files or software upgrades. A USB keyboard and mouse also can be attached to these ports to provide access to the Control Panel. (A USB mouse is provided with the unit.)

F Monitor, Media I and Media II network, and keyboard and mouse ports — The following ports are contained on this card:

- **Monitor port:** Connect an optional monitor to this 15-pin VGA connector to enable viewing of internal settings during basic setup, servicing, and fault diagnostic procedures. (This port is not used for normal operation.)
- **Keyboard and mouse port:** Use a splitter cable if you want to attach a PS/2 keyboard (provided with the unit) and a PS/2 mouse (not provided) to this mini DIN connector. Use this port when you need to perform basic system setup or troubleshooting (see **Connecting a PS/2 keyboard, USB mouse, and monitor** on page 46).
- **Media I and II network ports (Elite models only):** These two Ethernet ports (one 1000Base-T and one 100Base-T) can be used to connect the Elite 408 to external LANs or WANs to access remote Quantum QGE sources (optional). Connect CAT5 STP patch cables between these connectors and the network.

NOTE: A Quantum processor can simultaneously display a maximum of 25 QGE 100 sources.

Card Connections and Functions

This section describes the cards that can be installed in the Quantum processor and provides instructions for connecting to the ports on each card, along with a connection example for each.

Control Card

The Control card is installed in the second slot from the left in all models. Connect a computer that is running the Quantum Control Software to the fast Ethernet (100Base-T) Control port on this card to enable you to control the Quantum processor and to set up videowall applications via the computer.

As an alternative to the computer, connect this port directly to the QC 101 Controller or to a network to which the QC 101 controller also is connected.

NOTE: Ensure that the controller and the quantum processor are on the same subnet.

Direct and indirect connections

The connection from the Quantum Control port to the computer can be direct or indirect (see [figure 17](#) on the next page). For a single videowall processor you can use either method, but for a setup with multiple processors you must use the indirect method (for example, via a network switch).

Computer connections:

- A **direct** connection uses a single cable that is connected between the network port of the computer and the Quantum Control port. A 6-foot (1.8 meters) crossover cable is provided.
- An **indirect** connection is made via a switch, router, or local area network, using a straight-through, **not** a crossover, cable (not provided).

QC 101 connections:

- A **direct** connection uses a single cable that is connected between the LAN port of the QC 101 and the Quantum Control port.
- An **indirect** connection is made from the QC 101 LAN port via the network, using a straight-through cable (not provided). This type of connection can be used to connect one or multiple Quantums to the QC 101.

The network port on the computer or the network hub, router, or LAN must be able to support a 100Base-T connection. When the Quantum processor is delivered, it is set with the following default addresses and values:

- **IP address:** 192.168.254.254
- **Subnet mask:** 255.255.0.0
- **Gateway:** 0.0.0.0

To change these addresses, use the Quantum Control Panel (see [Using the Control Panel](#) on page 61).

NOTE: To enable communications between the computer or QC 101 and the processor, the Quantum IP address and subnet mask must be compatible on both:

- The subnet mask must be the same for all devices.
- The IP addresses must be different, but on the same subnet.

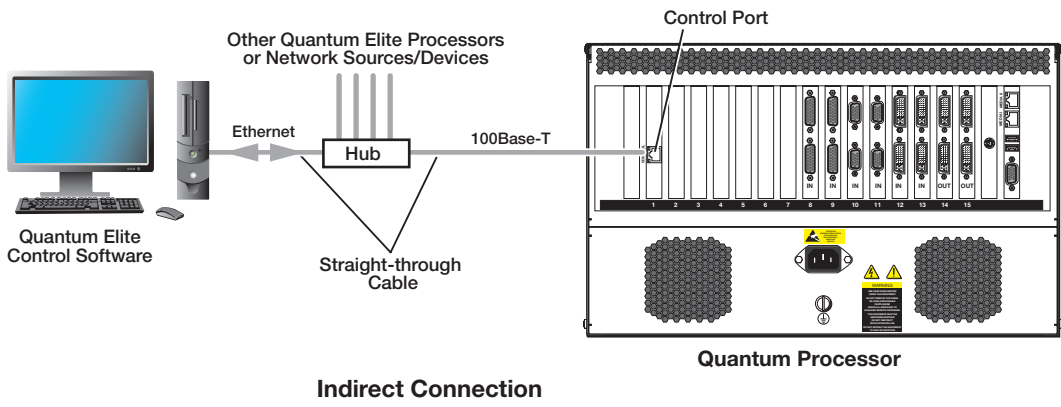
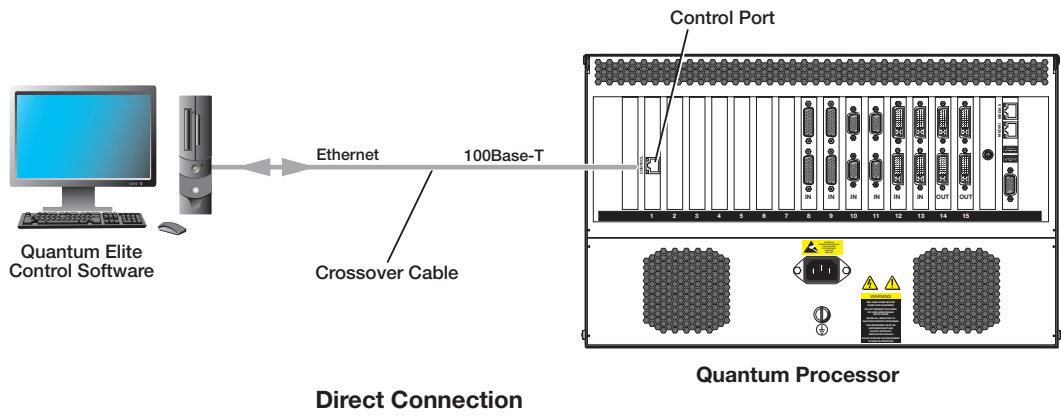

Figure 17. Ethernet Control Port Connection Types

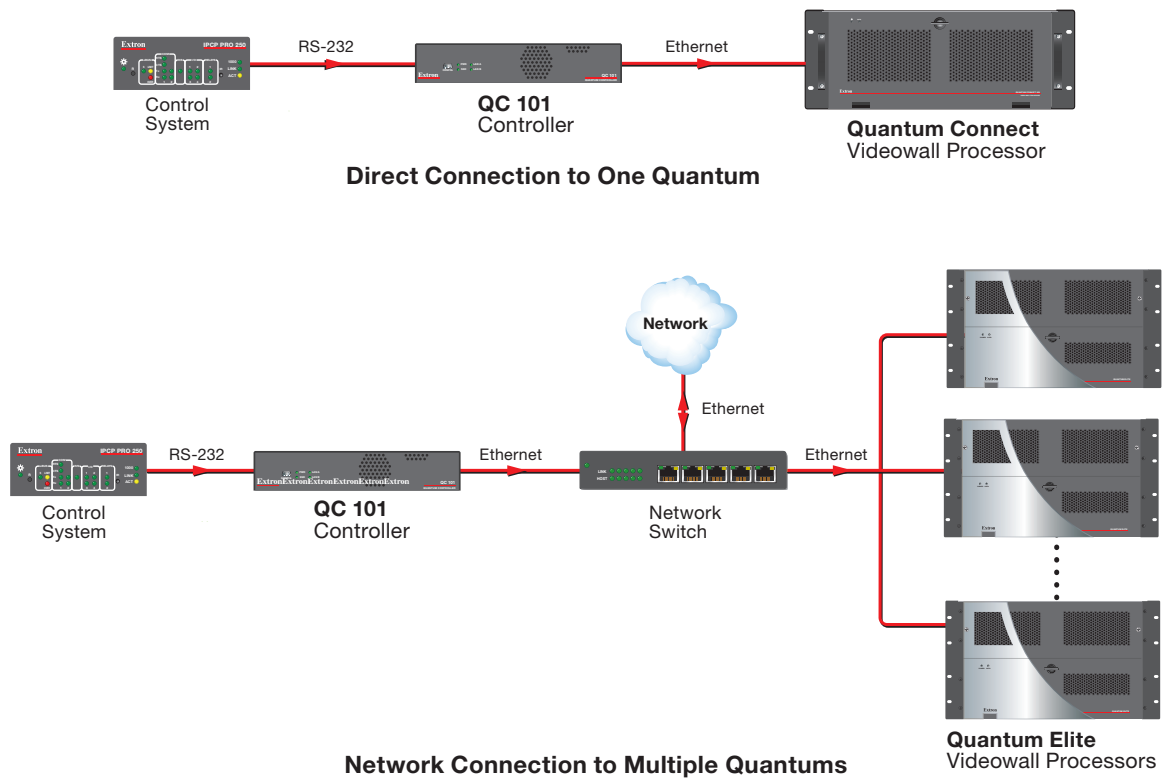

Figure 18. QC 101 Connection Examples

Input Cards

Analog and digital video sources such as computers, cameras, Blu-ray™ or DVD players, and video servers are input to the Quantum processor through one or more of the Quantum input cards. These cards provide digitization, deinterlacing, and down-scaling of sources as well as full source auto-detection.

Input card locations

Any combination of the four input card types can be installed in the slots available for inputs as follows:

- **Quantum Elite 615** — Slots 2 through 14, plus slot 0 if all the other slots in the card frame are full, enabling up to 14 input cards to be installed.
- **Quantum Elite 408** — Slots 1 through 7.
- **Quantum Connect** — Slots 3 through 6 (Connect 84) or slots 4 through 7 (Connect 82) are preconfigured with HDMI input cards that cannot be replaced.

NOTES:

- At least one input card is required.
- Slot 15 on the Elite 615 and slot 8 on the Elite 408 and Connect can contain only output cards. They cannot be used for inputs.
- If your Quantum Elite has multiple types of input cards, the cards must be installed in the following order, from **right to left**:
 1. **SDI** (installed to the left of the last output card)
 2. **HDMI** (installed to the left of the last SDI card)
 3. **DVI** (installed to the left of the last HDMI card)
 4. **RGB/YUV** (installed to the left of the last DVI card)
 5. **Video/S-video** (installed to the left of the last RGB card)All cards of the same signal type must be placed next to each other in the card frame.
- The number of sources that can be displayed simultaneously depends on the rectangulation of the output cards (see **Output Cards** on page 39).

EDID management

The Quantum EDID Minder manages the EDID for all the inputs. By default, input EDID is set to 1920x1200 @ 60 Hz. In addition, the user assigned mode allows pre-stored EDIDs, based on user selected resolutions, to be manually assigned to the sources. By maintaining continuous EDID communication with all sources, EDID Minder ensures that all sources power up properly and maintain their video outputs whether or not they are actively connected to the display device through the Quantum outputs.

Alternatively, you can set the EDID properties for each of the inputs installed in your Quantum card frame using the Quantum Control Software. The software also lets you view the current EDID that has been set for each input. The following EDIDs can be selected for an input at 50 or 60 Hz:

- | | | | |
|--------------------------------------|-------------|-------------|---------------------|
| • 640x480 | • 1280x768 | • 1366x768 | • 1600x1200 |
| • 800x600 | • 1280x800 | • 1440x900 | • 1920x1200* |
| • 848x480 | • 1280x1024 | • 1400x1050 | • 720p |
| • 1024x768 | • 1360x768 | • 1680x1050 | • 1080p |
| • Current display EDID (on output 1) | | | |

*Default

If no project file has been saved on the Quantum, the default EDID setting of 1920x1200 at 60 Hz is applied.

See the *Quantum Control Software User Guide*, provided on the Quantum CD, for details on selecting and monitoring EDIDs.

Source down-scaling

Each input card has an on-board scaler that down-scales the video sources in size to 1/16 of the original source (horizontally, vertically, or both). For simplicity, the example in the diagram below assumes that each screen in the target display has the same resolution as the source.

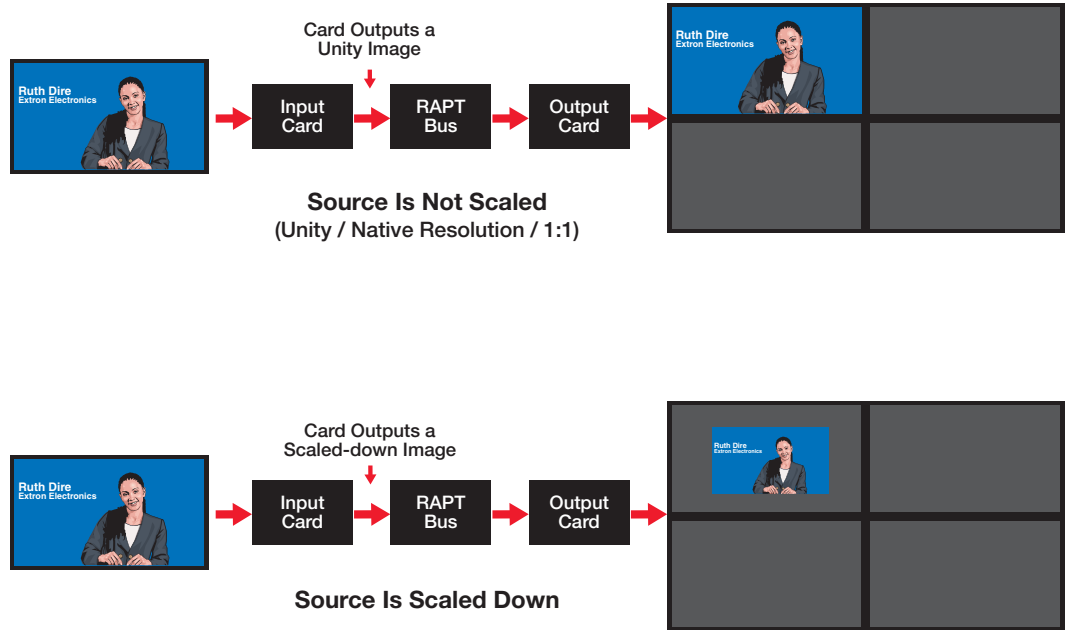

Figure 19. Example of a Source Displayed Full-Sized and Down-scaled

NOTE: Sources emanating from the PCI bus (such as image files) are down-scaled to the appropriate size by the output card graphics processor (GPU).

Up-scaling (magnification) is achieved by a scaler on the output card (see [Source up-scaling](#) on page 41).

Detailed information on connecting to these input cards is provided in the following sections.

Video/S-video input card (Quantum Elite only)

The Video/S-video input card enables you connect up to 12 composite video sources, S-video (YC) sources, or both types in combination. You can connect input devices to one or both connectors via one or two of the provided breakout adapter cables.

The Quantum Elite 615 card frame can accommodate up to 14 Video/S-video input cards, allowing up to 168 video source inputs. The Quantum Elite 408 and the Quantum Connect card frames can each hold up to 7 video cards, allowing up to 84 inputs.

The Video/S-video input card performs the following:

- **Auto-detection of source types:** Full auto-detection is provided on each input.

NOTE: PAL 60 format is not supported. PAL 60 is commonly output by European VCRs when playing back an NTSC tape.

Automatic gain control (AGC) ensures optimum source display with signals as low as 20% of normal amplitude.

NOTE: Due to the dynamic nature of AGC an identical source fed to different inputs may not display with identical results.

- **Deinterlacing:** Sources that are connected to the Video/S-video input card are interlaced scan and need to be converted to a progressive scan (deinterlaced).
- **Down-scaling of composite and S-video sources:** Independent horizontal and vertical scaling is possible down to 1/16 of native resolution. For example, a source of 720x486 pixels can be scaled down to approximately 45x31 pixels.

More than one scaled version of each source is possible, subject to the maximum number of sources supported by the scaler.

In the following table, “Real Time” refers to the number of windows that can be created without any reduction in frame rate. “Absolute” refers to the maximum number of windows that can be created.

Source Type	Deinterlacing	Maximum Number of Sources Supported per Card*	
		Real Time	Absolute
Video/S-video (PAL, NTSC, SECAM)	Single field	30	64
	Three field	15	64

* Also dependant on the source capacity of the RAPT bus

Connecting composite video sources

- **Input connectors:** The Video/S-video input card contains two female 26-pin D type connectors, to which the breakout cables are attached for composite video or S-video.
- **Breakout cables (adapters):** Each of the two provided breakout cables has a male 26-pin, high-density, D-type connector attached to 12 flying leads terminated in BNC connectors (see the [figure 20](#) on the next page). The BNC connectors are labeled 1 through 12. (The second breakout cable, if connected, is used only for S-video connections.)

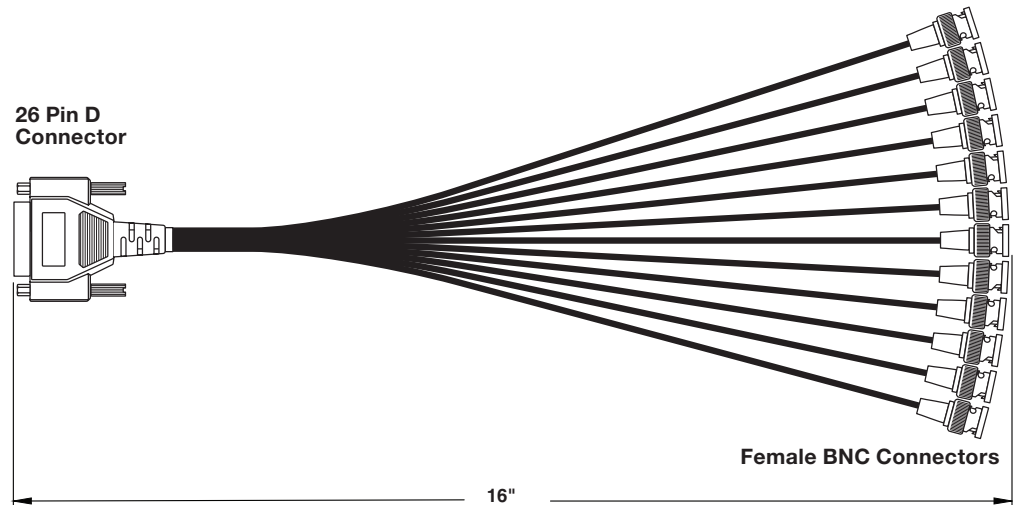

Figure 20. Breakout Cable for Video and S-video Sources

- **Cables:** The recommended cable type to connect a source device to the breakout cable is a low-loss 75 ohms coaxial cable. Cabling distance between the source and the Video/S-video input card can be up to 32 feet (10 meters).

To connect composite video sources to the Video/S-video input card:

1. Connect the 26-pin D connector of the breakout cable to the **top** connector on the Video/S-video card. (The bottom connector is used only for S-video sources.)
2. Connect a BNC cable from each composite video input device to one of the BNC connectors of the breakout cable, starting with the connector labeled **1** (or the lowest numbered BNC connector available).

Connecting S-video sources

To connect S-video sources, use both provided breakout cables and both connectors on the Video/S-video input card, as follows:

1. Connect both breakout cables to the 26-pin D connectors on the Video/S-video input card.
2. Connect a BNC cable from an S-video input device to the lowest-numbered BNC connector available on **both** breakout cables, as follows:
 - Connect the **Y** (luma) cable of the source to the breakout cable attached to the **top** D-type connector on the Video/S-video input card.
 - Connect the device **C** (chroma) cable of the source to the breakout cable attached to the **bottom** connector on the card.
 - Ensure that the Y and C cables of the S-video device are attached to the BNC connectors with the **same** number on both breakout cables.

NOTE: The breakout cable connected to the bottom connector on the Video/S-video input card should have only the C cables of S-video devices attached.

- Repeat step 2 for any additional S-video devices that you want to connect.

Connector pin assignments

Top connector:

Pin	Function	Pin	Function	Pin	Function
1	CVBS or Y 1 in	10	Ground	19	CVBS or Y 7 in
2	CVBS or Y 2 in	11	Ground	20	CVBS or Y 8 in
3	CVBS or Y 3 in	12	Ground	21	CVBS or Y 9 in
4	CVBS or Y 4 in	13	Ground	22	CVBS or Y 10 in
5	CVBS or Y 5 in	14	Ground	23	CVBS or Y 11 in
6	CVBS or Y 6 in	15	Ground	24	CVBS or Y 12 in
7	Ground	16	Ground	25	Ground
8	Ground	17	Ground	26	Ground
9	Ground	18	Ground		

Bottom connector:

Pin	Function	Pin	Function	Pin	Function
1	C 1 in	10	Ground	19	C 7 in
2	C 2 in	11	Ground	20	C 8 in
3	C 3 in	12	Ground	21	C 9 in
4	C 4 in	13	Ground	22	C 10 in
5	C 5 in	14	Ground	23	C 11 in
6	C 6 in	15	Ground	24	C 12 in
7	Ground	16	Ground	25	Ground
8	Ground	17	Ground	26	Ground
9	Ground	18	Ground		

Video and S-video connection example

The diagram below shows an example of composite and S-video sources connected to the Video/S-video input card via breakout cables.

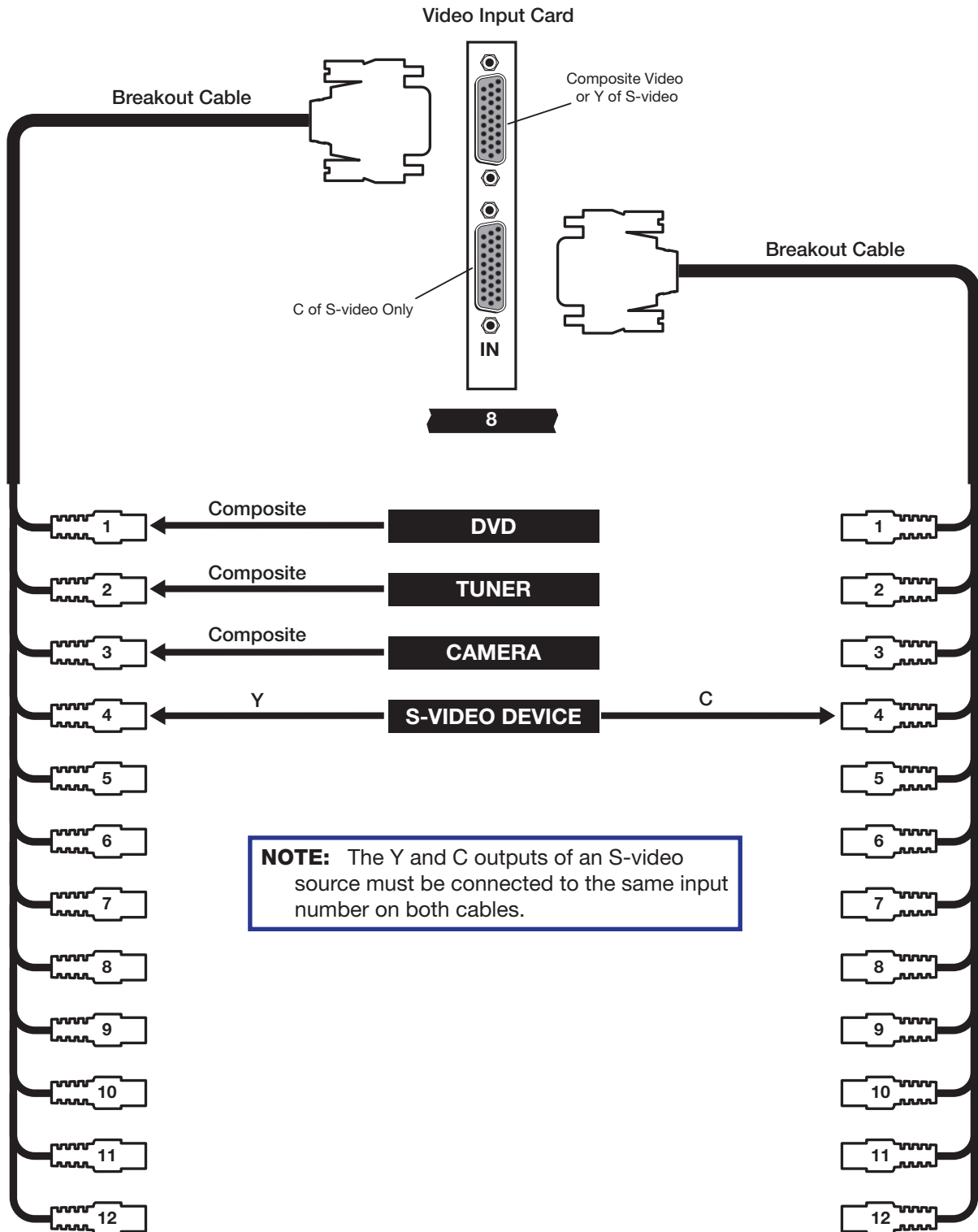

Figure 21. Video/S-video Input Card Connection Example

Analog RGB/YUV input card (Quantum Elite only)

Analog RGB/YUV cards are installed immediately to the left of the DVI cards. Connect one or two analog RGB graphics sources or HD video sources (in RGB or component YPrPb format) to the VGA connectors on this card.

- **Input connectors:** The RGB/YUV input card contains two female 15-pin VGA connectors. The Quantum Control Software identifies the inputs by the connector to which they are attached. The upper connector is recognized as input 1. The bottom connector is input 2.

Example: The top VGA connector on the card in slot 4 is identified as 4.1.

- **Cables:** The recommended cable type for this RGB connection is a low-loss 75 ohms cable with a maximum length of 32 feet (10 meters). If more inputs are required, you can use multiple card frames.

The Quantum Elite 615 model can accommodate up to 14 input cards, allowing a maximum of 28 RGB or HD source inputs (two per card). The Quantum Elite 408 can accommodate up to 7 input cards, allowing a maximum of 14 RGB/YPrPb video source inputs.

Down-scaling of RGB or HD video sources

The on-board scaler provides down-scaling of RGB and HD sources. Independent horizontal and vertical scaling is possible down to 1/16 of native resolution. For example, a source of 1600x1200 pixels can be scaled down to around 100x75 pixels.

More than one scaled version of each source is possible, subject to the maximum number of sources supported by the scaler.

In the following table, “Real Time” refers to the number of windows that can be created without any reduction in frame rate. “Absolute” refers to the maximum number of windows that can be created.

Source Type	Maximum Number of Sources Supported per Card*		
	Real Time		Absolute
	50 Hz	60 Hz	
HD 1080i	7	5	64
HD 1080p	3	2	64
HD 720p	8	6	64
UXGA	3	3	64
SXGA+	5	4	64
SXGA	5	4	64
WXGA	7	6	64
XGA	9	7	64
SVGA	15	12	64

* Also depends on the source capacity of the RAPT bus.

RGB/YUV connector pin assignments

The following diagram shows the pin assignments for the 15-pin high-density D-type connectors on the RGB/YUV input card.

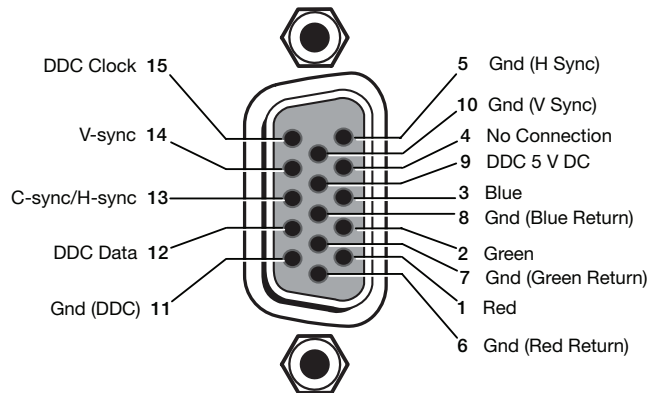

Figure 22. Pin Assignments for the RGB Connectors

RGB or component video connection example

The diagram below shows an example of RGB and component video sources connected to the RGB/YUV input card.

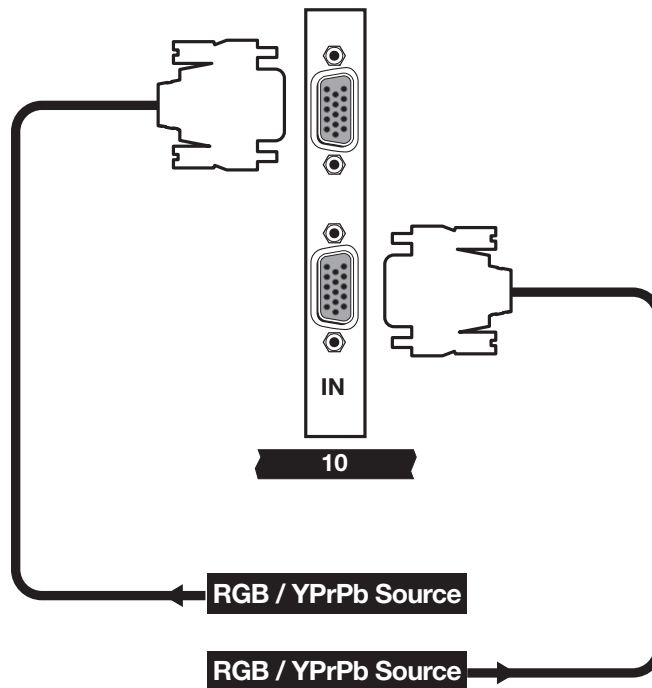

Figure 23. RGB/YUV Input Card Connection Example

DVI input card (Quantum Elite only)

The DVI input cards are installed immediately to the left of the HDMI input cards in the card frame. Connect one or two DVI-D video or graphics sources to the input connectors on this card. The two DVI connectors are identical and can be used interchangeably. They provide down-scaling of sources as required.

- **Input connectors:** The DVI input card contains two female 29-pin DVI-I connectors.
- **Cables:** DVI single or dual link video cables are recommended for this DVI connection, 16 feet (5 meters) maximum. (Dual link signals are not supported.)

The Quantum Elite 615 model can accommodate up to 14 input cards, allowing a maximum of 28 DVI video source inputs (two per card). The Quantum Elite 408 can accommodate up to 7 input cards, allowing a maximum of 14 DVI video source inputs. If more inputs are required, multiple card frames can be used.

Connector pin assignments

The following diagram shows the pin assignments for the 29-pin DVI-I connectors on the DVI input card.

Pin	Signal	Pin	Signal	Pin	Signal
1	TMDS data 2-	9	TMDS data 1-	17	TMDS data 0-
2	TMDS data 2+	10	TMDS data 1+	18	TMDS data 0+
3	Ground (2/4)	11	Ground (1/3)	19	Ground (0/5)
4	Not used	12	Not used	20	Not used
5	Not used	13	Not used	21	Not used
6	DDC clock	14	+5 V power	22	Ground (clock)
7	DDC data	15	Ground (for 5 V)	23	TMDS clock+
8	Not used	16	Hot plug detect	24	TMDS clock-

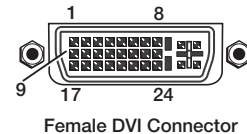

NOTE: The analog pins (C1 through C5, shown at right) are not enabled.

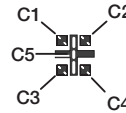

Figure 24. DVI Input Connector Pin Assignments

DVI input card connection example

The following diagram shows an example of DVI sources connected to the DVI input card.

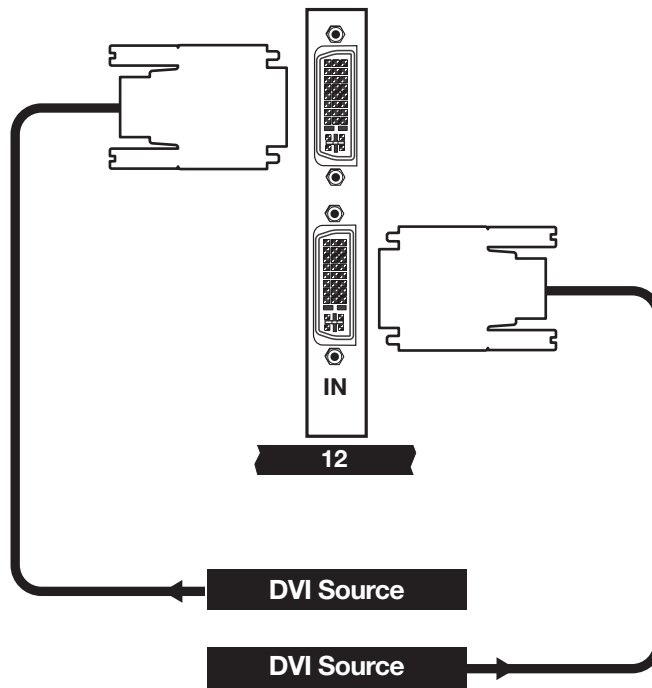

Figure 25. DVI Input Connection Example

HDMI Input Card (all models)

The HDMI input cards are installed immediately to the left of the SDI cards in the card frame of a Quantum Elite. On the Quantum Connect models, HDMI input cards are preinstalled and cannot be removed or replaced. They are HDCP-compliant when used with Quantum HDMI output cards and HDCP-compliant displays. Connect one or two HDMI video or graphics sources to the input connectors on this card. The two HDMI connectors are identical and can be used interchangeably. They provide down-scaling of sources as required.

NOTE: The HDMI connectors also support DVI signals. Appropriate HDMI to DVI cables or adapters are required for DVI signal input on this card.

- **Input connectors:** The HDMI input card has two female HDMI type A connectors.
- **Cables:** HDMI single or dual link video cables are recommended for this HDMI connection, 25 feet (7.6 meters) maximum. (Dual link signals are not supported.)
- **HDCP Compliance LEDs:** The HDMI input card contains two tri-color LEDs (one for each connector) that light to indicate the HDMI source signal status and HDCP compliance:

Input LED Color	Status Definition
Off	No signal
Red	Unsupported signal
Green	Unencrypted HDMI or DVI signal
Amber	HDCP encrypted HDMI or DVI signal

- HDMI LockIt Cable Lacing bracket:** An Extron LockIt cable lacing bracket is provided with the Quantum to enable you to secure the HDMI device cable to the HDMI input connector to prevent intermittent or complete signal loss due to a loose cable connection. Above each connector is a hole into which an HDMI connection mounting screw (provided) can be inserted to attach the lacing bracket to the Quantum rear panel. (See the provided *LockIt HDMI Lacing Bracket Installation Guide* card for more information on attaching the bracket.)

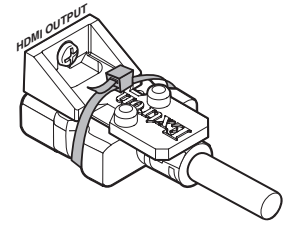

Top Mounted

- The Quantum Elite 615 can accommodate up to 14 input cards, allowing a maximum of 28 HDMI video source inputs (two per card). The Quantum Elite 408 and the Quantum Connect can each have up to 7 HDMI input cards, with a maximum of 14 HDMI video inputs. If more inputs are required, multiple card frames can be used.

HDMI connector pin assignments

Pin	Signal	Pin	Signal	Pin	Signal
1	TMDS data 2+	7	TMDS data 0+	13	CEC*
2	TMDS data 2 shield	8	TMDS data 0 shield	14	Reserved (NC)
3	TMDS data 2-	9	TMDS data 0-	15	SCL (DDC clock)
4	TMDS data 1+	10	TMDS clock+	16	SDA (DDC data)
5	TMDS data 1 shield	11	TMDS clock shield	17	DDC/CEC ground
6	TMDS data 1-	12	TMDS clock-	18	+5 V power
				19	Hot plug detect

*Not supported

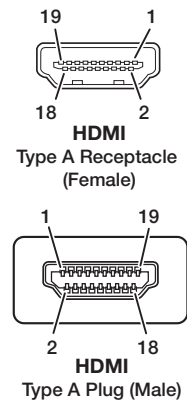

Figure 26. HDMI Connector Pin Assignments

HDMI input card connection diagram

Figure 26 shows a diagram of HDMI sources connected to the HDMI input card.

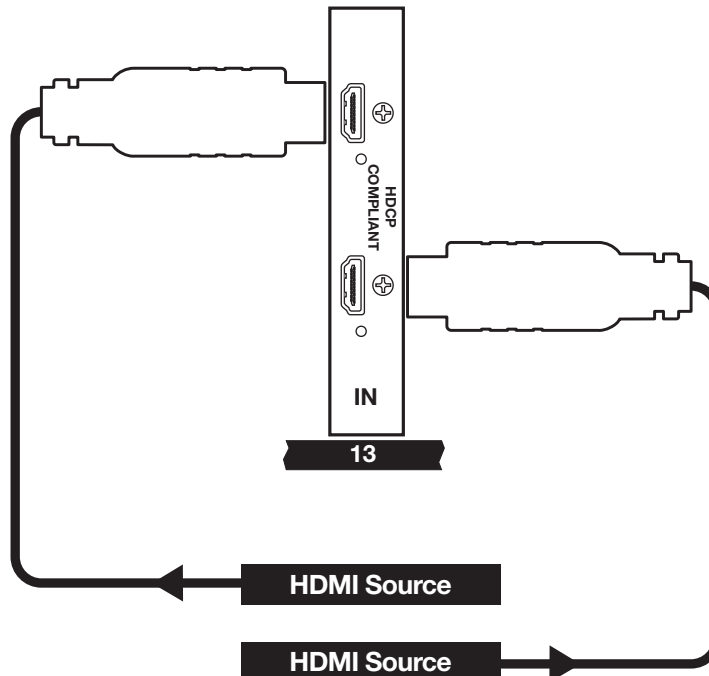

Figure 27. HDMI Input Connection Example

3G-SDI Input Card (Quantum Elite only)

Connect one or two 3G-SDI, HD-SDI, or SD-SDI video or graphics sources to the input connectors on this card (in any combination of SDI signal types). These cards are installed immediately to the left of the output cards in the card frame.

NOTE: The Quantum detects the SDI input signal format (3G-SDI, HD-SDI, or SD-SDI) and sets the input to support it.

- **Input connectors:** The SDI input card has two female HD-BNC connectors.
- **Adapter cables:** For each SDI card, two female BNC-to-male HD-BNC adapter cables are provided to enable connection of devices with standard BNC cabling to the HD-BNC connectors on the card.
- **Motion adaptive deinterlacing:** The SDI card features an advanced deinterlacing process, which ensures that NTSC, PAL, and 1080i sources are supported and deinterlaced properly prior to being placed onto the RAPT bus. By default, deinterlacing is enabled. To save bandwidth on the RAPT bus if deinterlacing is not a priority, you can disable the deinterlacing.
- **Film mode detection:** All advanced film mode cadences are supported and can be automatically detected (see the *Quantum Control Software User Guide* for information on enabling and disabling film mode auto-detection).

The Quantum Elite 615 can accommodate up to 14 input cards, allowing a maximum of 28 SDI video source inputs (two per card). The Quantum Elite 408 and the Quantum Connect can each have up to 7 SDI input cards, with a maximum of 14 SDI video inputs. If more inputs are required, multiple card frames can be used.

Input resolutions

The SDI card supports the following SMPTE input resolutions:

Resolution	Refresh Rates (Hz)
480i	59.94
576i	50
720p	23.98, 24, 25, 29.97, 30, 50, 59.94, 60
1080i	50, 59.94, 60
1080p	23.98, 24, 25, 29.97, 30, 50, 59.94, 60

Figure 28 on the next page shows a diagram of SDI sources connected to the SDI input card.

SDI input card connection example

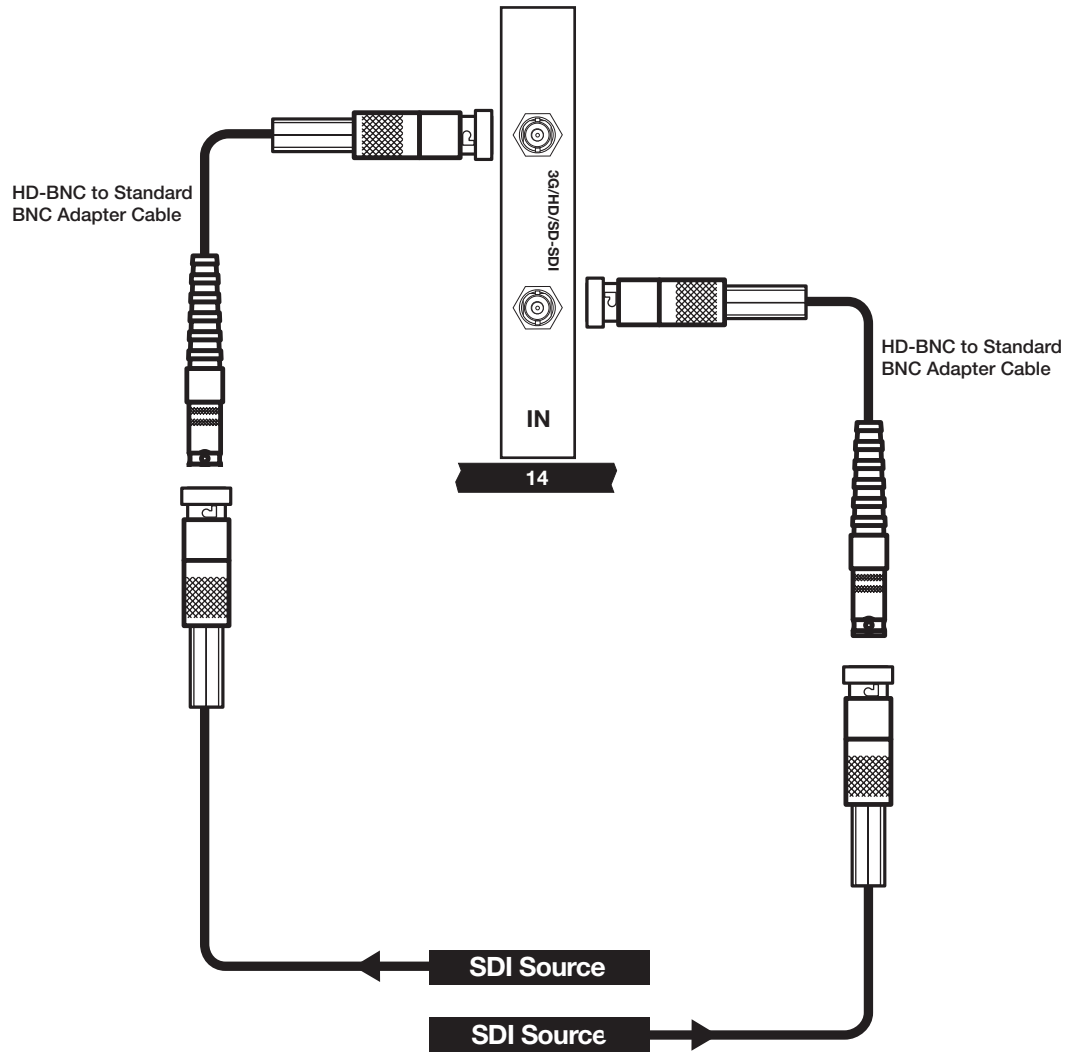

Figure 28. SDI Input Connection Example

Output Cards

The Quantum DVI-I and HDMI output cards provide the final output to a display device. They integrate all inputs to be displayed in a layout that you define using the control software (see the *Quantum Control Software User Guide* for information on using the program to set up displays). They also provide up-scaling of sources.

The HDMI output cards are HDCP-compliant when used with Quantum HDMI input cards and HDCP-compliant displays.

Source signals are delivered to the output cards via either the RAPT or the PCI bus.

- **Connectors:** The output cards contain either two female 29-pin DVI-I connectors or two female type A HDMI connectors, to which you can connect one or two display devices. Each output channel is capable of driving a standalone display device or one screen element in a videowall.

NOTE: You can also connect DVI display devices to the HDMI output connectors using a DVI-to-HDMI cable or adapter.

The Quantum Control Software identifies the outputs by the connector to which they are attached. The upper connector is recognized as output 1; the bottom connector, as output 2.

- **HDMI LockIt bracket:** An Extron LockIt cable lacing bracket is provided with the Quantum to enable you to secure the HDMI device cable to the HDMI output connector (see the provided *LockIt HDMI Lacing Bracket Installation Guide* card for information on attaching the bracket).
- **Signal formats:** The output signal format can be analog (RGB on DVI-I connectors) or digital (DVI or HDMI), with resolutions from VGA (640x480) to WXGA (1920x1200) or 1080p (1920x1080) and refresh rates up to 60 Hz.
- **Cables:** The recommended cable types for the output connections are:
 - **Digital signals:**
 - **DVI:** Single or dual link digital video cable with a maximum length of 16 feet (5 meters).
 - **HDMI:** Singlelink high-speed HDMI video cable with a maximum length of 25 feet (7.6 meters).
 - **Analog signals:** DVI to analog video cable with a maximum length of 32 feet (10 meters).

Output card locations

Place the first output card in the **first** slot on the **right** (slot 15 on the Quantum Elite 615, slot 8 on the Quantum Elite 408 or the Quantum Connect). If your system has both DVI-I and HDMI output cards, install the first HDMI card in the rightmost slot. Place any additional HDMI output cards in the slots immediately to the left of the first HDMI card. Install the DVI output cards in the slots to the left of the last HDMI card.

- The Quantum Elite 615 can accommodate up to 14 output cards, allowing a maximum of 28 display outputs.
- The Quantum Elite 408 can accommodate up to 7 output cards, allowing a maximum of 14 display outputs.
- The Quantum Connect 84 has 2 output cards preinstalled and the Connect 82 has 1.

LEDs on the HDMI output card

The HDMI output card contains two tri-color LEDs (one for each connector) that light to indicate the HDMI output signal status and HDCP compliance:

Output LED Color	Status Definition
Off	Not defined in the output array
Red	Not applicable
Green	Unencrypted (non-compliant) HDMI or DVI signal
Amber	HDCP encrypted (compliant) HDMI or DVI signal

Connecting a display to the output card

You can connect up to two display devices to an output card. The top connector is for output channel 1; the bottom connector is for output channel 2.

The outputs can drive analog or digital display devices at a variety of resolutions (see the *Quantum Control Software User Guide* to configure the display connections).

When connecting an analog display, you can use either a DVI-A type connector and cable or the provided DVI-to-VGA adapter (to allow connection of a conventional 15-pin style VGA cable).

Output connector pin assignments

Figure 26 shows the pin assignments for the DVI output connectors.

NOTE: The pin assignments are the same for HDMI input and output connectors (see [HDMI connector pin assignments](#) on page 36).

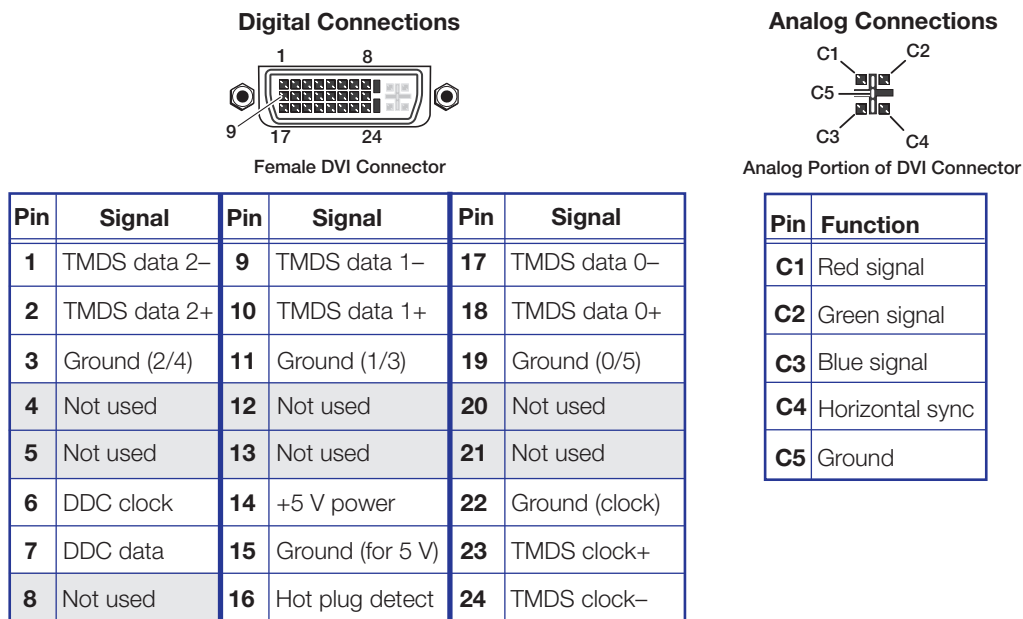

Figure 29. DVI Output Connector Pin Assignments

Source up-scaling

The on-board scaler on the output card provides up-scaling of video, RGB, DVI, HDMI, and QGE 100 sources. Independent horizontal and vertical scaling is possible up to 16 times native resolution. For example, a source of 720x486 pixels can be scaled up to approximately 11520x7776 pixels.

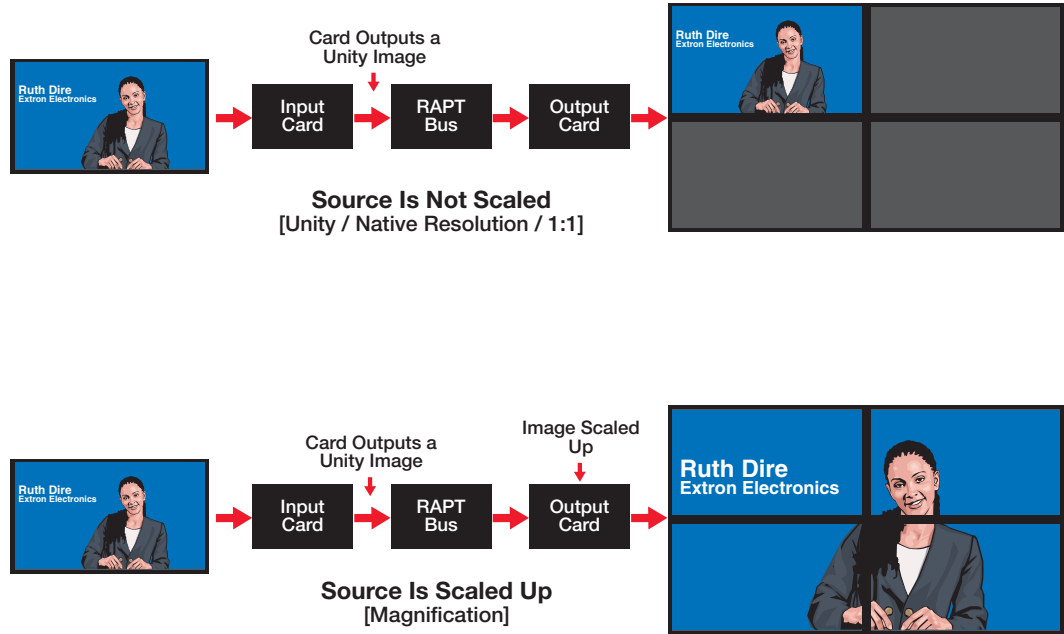

Figure 30. Example of a Source Displayed Full-sized and Up-scaled

NOTE: Where image files need to be up-scaled, these are rendered at the appropriate size by the graphics processor (GPU). This ensures maximum image sharpness.

Down-scaling of video, RGB, HDMI, and DVI sources is performed by a scaler on the input cards (see [Source down-scaling](#) on page 27 for further details).

Output Channels

The two output channels on each card can be used to drive separate displays or individual screen elements within a larger tiled display.

In a tiled display, each output card channel pair can be configured to output any region of the overall display.

Output Channel Identification

The control software identifies each output channel by the slot number in which the output card is installed and by the card channel number (1 or 2).

For example, if two output cards are installed in slots 7 and 8, the output channels are identified as 7.1, 7.2, 8.1, and 8.2 (see the DVI example in figure 28).

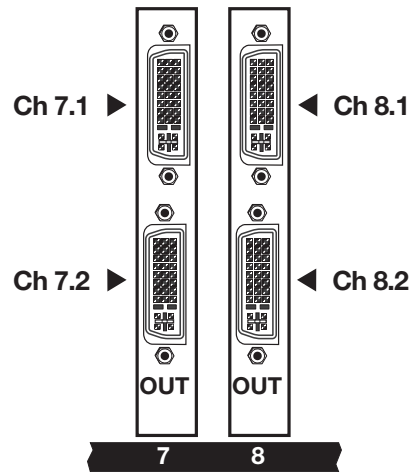

Figure 31. DVI Channel Identification Example

Output Channel Mapping

When connecting multi-screen displays, consider the order in which screens are connected to the various output channels.

You can use the Quantum Control Software to map any output card to any location on the target display (see the *Quantum Control Software User Guide*, available at www.extron.com, for details and procedures for mapping). There are three ways to use the output channels of each card and the method you choose determines how you connect each screen.

- **Dual channel horizontal** — The channels drive two screens placed side by side.
- **Dual channel vertical** — The channels drive two screens placed one above the other.
- **Single channel** — Only channel 1 is used, and channel 2 is not connected. Use this method when the maximum number of windows need to be displayed on a single screen, or if there is an odd number of screens in the array.

Choose the method (or combination of methods) that best suits the layout of the display.

Connection and mapping examples

All of the display layout examples in figures 32 (below) and **figure 33** (on the next page) show channel numbering as seen from a viewing position in front of the screen. The digits to the left of the decimal point are the slot number of the card, and the digit to the right of the decimal point is the output channel number. Note that the actual slot numbers may vary between systems, but Extron recommends that you start with the lowest numbered card slot in the top left corner.

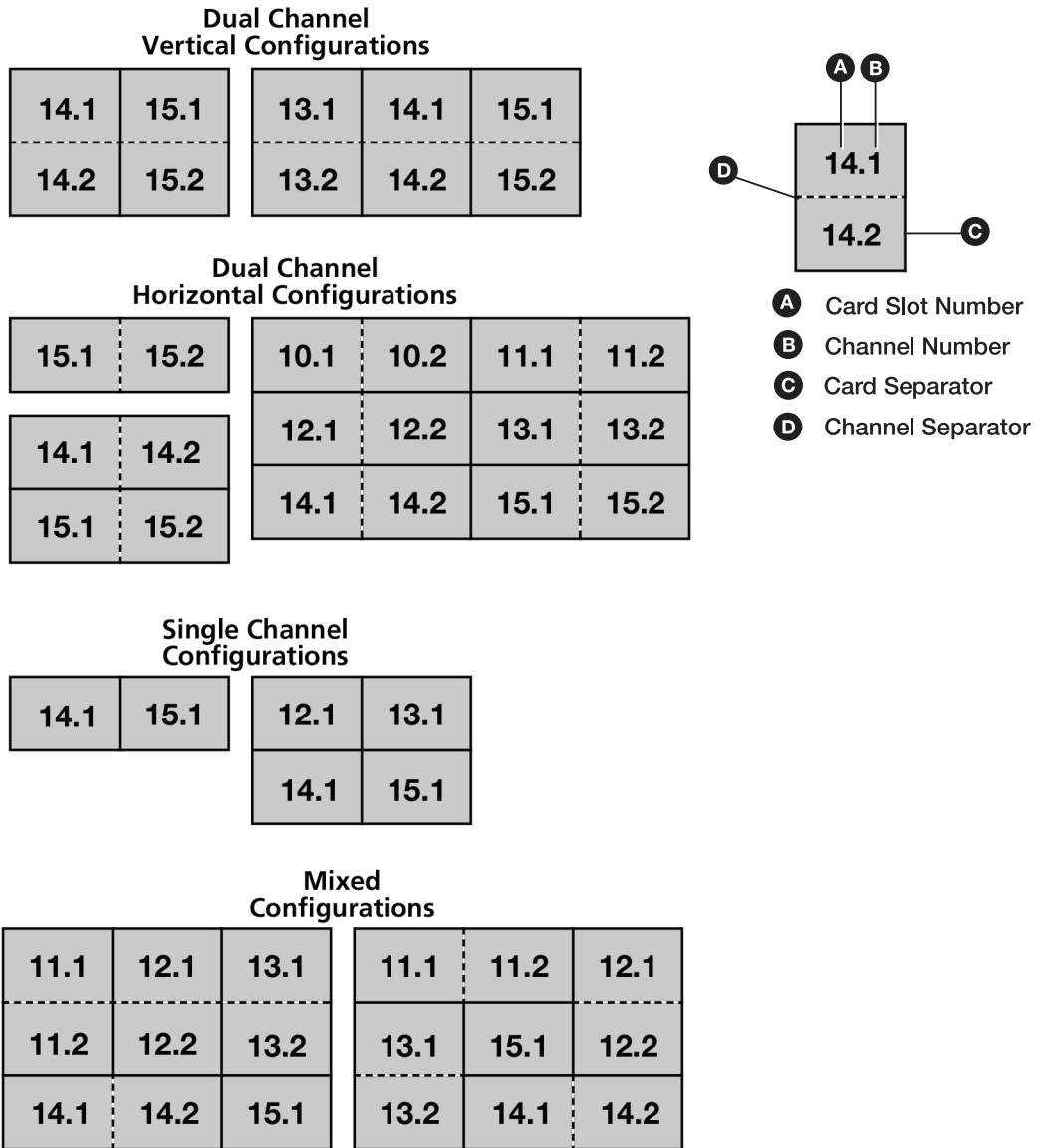

Figure 32. Channel Mapping Examples for Quantum Elite 615

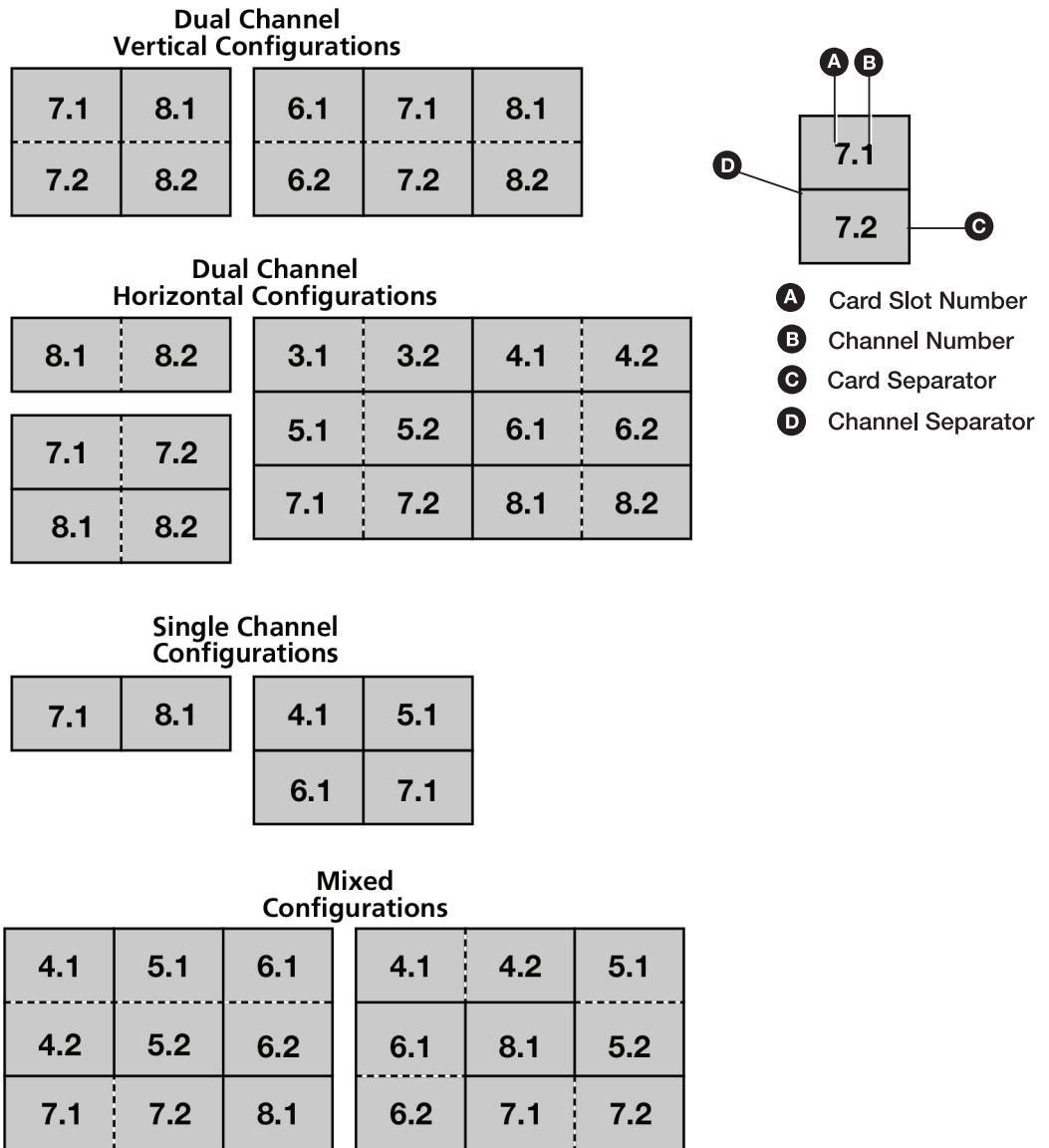

Figure 33. Channel Mapping Examples for Quantum Elite 408 and Quantum Connect

Input and Output Card Arrangements

The Quantum card frames are configured to order. Therefore, the combination and position of cards varies depending on your specified configuration. At least one output card and one input card are required. Other than that, any number or combination of input and output cards can be used, depending on the number of input or output channels required and the number of available slots.

NOTE: In a standard configuration, output cards are installed in the highest numbered slots, in other words, slot 15 downwards on the Quantum Elite 615 or slot 8 downwards on the Quantum Elite 408. On the Quantum Connects, output cards are installed in slot 8 (82 models) or 7 and 8 (84 models). Input cards are installed in the remaining slots nearest the output cards.

Maximum number of inputs and outputs – Quantum Elite 615

Output Cards	Output Channels	Input Cards	Video Input channels	RGB, HD, DVI, and SDI Input Channels
1	2	14	168	28
2	4	13	156	26
3	6	12	144	24
4	8	11	132	22
5	10	10	120	20
6	12	9	108	18
7	14	8	96	16
8	16	7	84	14
9	18	6	72	12
10	20	5	60	10
11	22	4	48	8
12	24	3	36	6
13	26	2	24	4
14	28	1	12	2

Maximum number of inputs and outputs – Quantum Elite 408 and Quantum Connect

Output Cards	Output Channels	Input Cards	Video Input Channels	RGB, HDMI, DVI, and SDI Input Channels
1	2	7	84	14
2	4	6	72	12
3	6	5	60	10
4	8	4	48	8
5	10	3	36	6
6	12	2	24	4
7	14	1	12	2

NOTES:

- A maximum of 128 sources can be viewed simultaneously with one output card.
- QGE 100 sources are transported over IP and require only a single video input card to transfer QGE data to the RAPT bus.

Keyboard, Mouse, Monitor, USB, and Media Cards

The two cards installed in the first two slots on the right side of the rear panel contain the connectors listed below. The locations of these connectors depend on the Quantum model.

- PS/2 keyboard connector
- Monitor connector
- USB ports (2)
- Media I and Media II network ports (Elite models only)

Connecting a PS/2 keyboard, USB mouse, and monitor

To access the Quantum Control Panel screens, connect a PS/2 or USB keyboard and USB mouse (provided) and a separate monitor (not provided) to the keyboard (or keyboard/mouse) and monitor connectors on the rear panel. The Control Panel screens enable you to perform such tasks as changing network settings, resetting the unit to its default settings, and placing the processor in service mode (see [Using the Control Panel](#) on page 61). The PS/2 keyboard, USB mouse, and the monitor are not required during normal operation of the processor.

NOTE: The Control Panel software resides on the Quantum processor and is used only for the system setup and trouble-shooting activities. This is not the same software as the Quantum Control Software, which is loaded on your computer for use in setting up the sources and displays and creating and managing presentations.

Keyboard and mouse PS/2 port pin assignments

Pin	Function
1	Data
2	No connection
3	Ground
4	+5 VDC supply
5	Clock
6	No connection

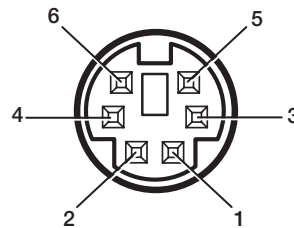

Figure 34. Pin Assignments for the Mini DIN Keyboard and Mouse Connector

Monitor connector pin assignments

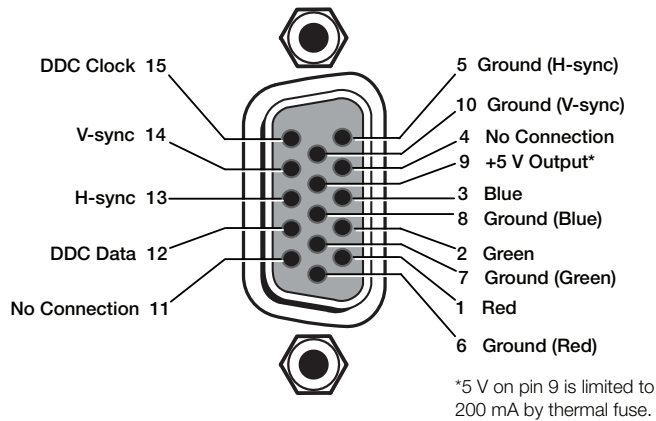

Figure 35. Pin Assignments for the Monitor Connector

Quantum Elite 408 and Quantum Connect keyboard, mouse, and monitor connections

On the Quantum Elite 408 and the Quantum Connect, one mini DIN connector for both the keyboard and the mouse is on the last card on the right in the card cage. For a PS/2 keyboard and mouse, connect a splitter cable (provided) from this connector to the cables of the keyboard and mouse (see figure 36). For a USB keyboard and mouse, connect them to the two USB connectors (see [figure 37](#) on the next page).

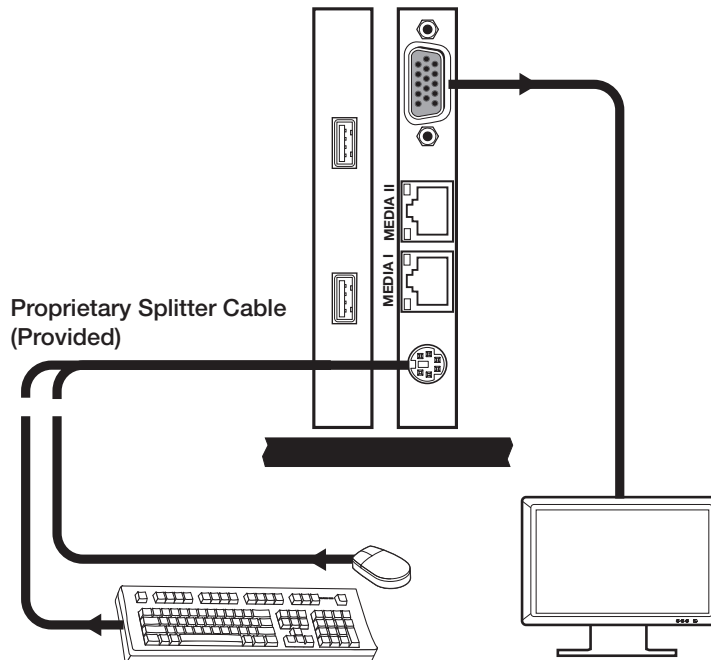

Figure 36. Connecting a PS/2 Keyboard, Mouse, and Monitor to a Quantum Elite 408 or a Quantum Connect

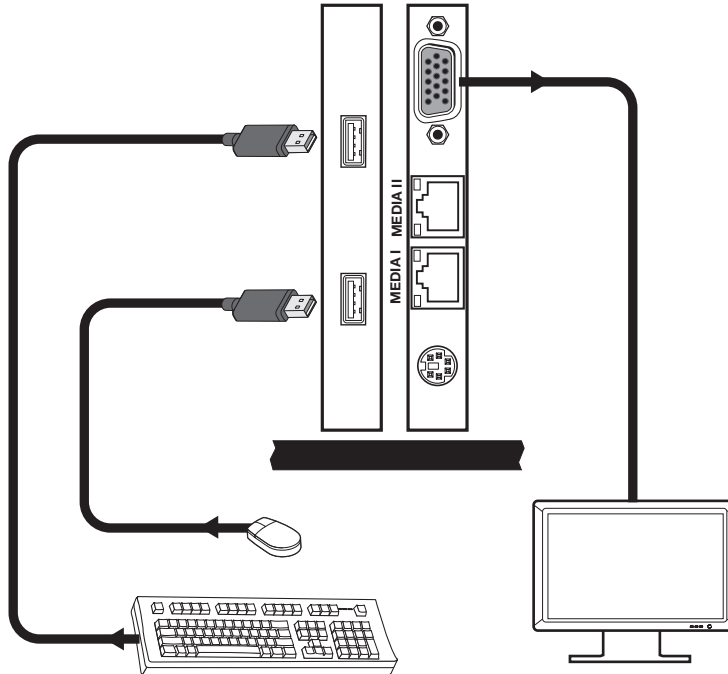

Figure 37. Connecting a USB Keyboard and Mouse to the Quantum Elite 408 or Quantum Connect

Quantum Elite 615 keyboard, mouse, and monitor connections

On the Quantum Elite 615, a mini DIN connector for the keyboard is located on the second card from the right in the card cage. The monitor connector is on the last card on the right (along with the USB connectors and the two Media network ports). Figure 35 shows how a keyboard, mouse, and monitor can be connected to a Quantum Elite 615.

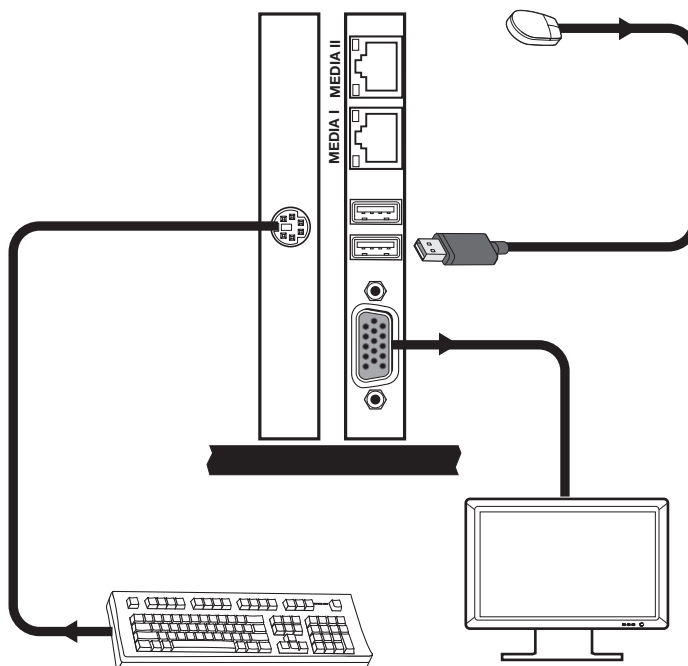

Figure 38. Connecting a Keyboard and Mouse to the PS/2 and USB Ports on the Quantum Elite 615

USB ports

All Quantum models have two USB ports, to either of which you can connect an optional USB storage device (such as a flash drive) or a USB keyboard, mouse, or both to access the Quantum Control Panel (see figure 39).

Using the Control Panel screens, you can perform functions such as loading image files to the Quantum from the connected USB storage device or uploading firmware directly from the storage device to the Quantum processor (see [Using the Control Panel](#) on page 61).

NOTE: Firmware can be uploaded **only** via the USB ports.

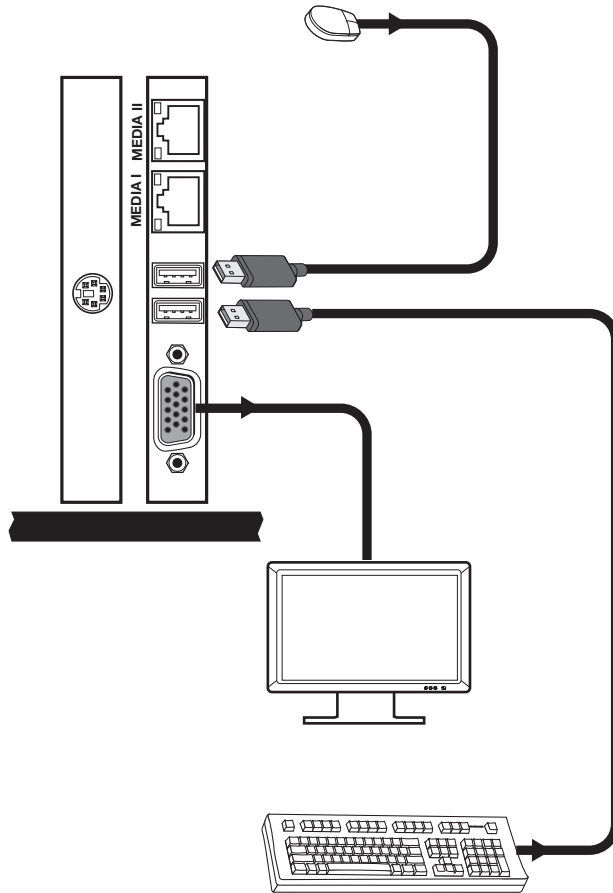

Figure 39. Connecting a Keyboard and Mouse to the USB Ports on the Elite 615

Media I and Media II network ports (Quantum Elite models only)

The Media I and Media II network ports allow the Quantum Elite to be connected to external Ethernet LANs or WANs in order to access remote QGE 100 RGB sources or network-based files or media.

NOTE: The Quantum Connect processor does not support the use of the Media I and Media II ports.

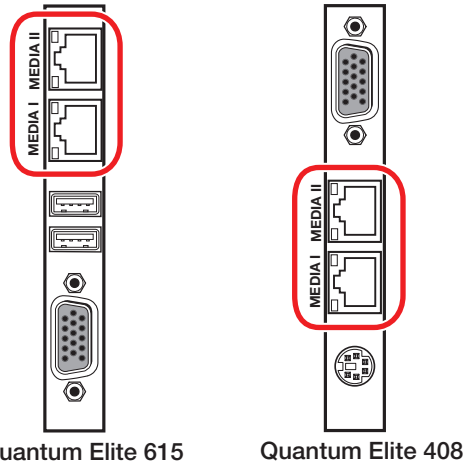

Figure 40. Media I and Media II Ports on Quantum Elite Models

Capturing QGE 100 RGB Graphics Sources

You can capture applications running on remote computers by using the QGE 100 Quantum Graphics Encoder, which provides for efficient, lossless transportation of RGB computer graphics over a standard IP network. The QGE 100 is a hardware-based graphics capture device that connects between the source computer and its keyboard, mouse, and the monitor. It allows the Quantum Elite to capture the desktop of the source computer and display it on the target display. On average, the QGE streams data at approximately 5 to 10 frames per second. It is best suited to sources with low to moderate motion content.

QGE 100 sources are delivered to the Quantum over an IP network. The Video/S-video input card transfers source data from the PCI bus to the RAPT bus. For this reason, at least one Video/S-video input card must be installed in every Quantum Elite card frame to use QGE sources.

NOTE: By using the QGE 100 lossless compression, RGB data bandwidth is dramatically reduced and results in more efficient use of the RAPT bus.

Connecting to the Media ports

On the Quantum Elite 615, the two Media ports are on the same card with the monitor and USB ports, installed in the first slot on the right. On the Quantum Elite 408, the network connectors are on the card that also contains the PS/2 keyboard/mouse and Monitor ports, which is in the second slot from the right. (The rightmost slot is not used.)

The Ethernet port speeds are:

- **Quantum Elite 615:** Media I and Media II are both 1000Base-T (gigabyte Ethernet)
- **Quantum Elite 408:** Media I is 100Base-T (fast Ethernet), while Media II is 1000Base-T (gigabyte Ethernet).

Use a CAT5 STP cable to connect the Quantum to your computer or the network node (see [Ethernet Connections](#) on the next page to cable these network ports).

Ethernet Connections

The Control port on all Quantum models and the Media I and Media II network ports on the Elite models are Ethernet ports on RJ-45 connectors. The Link and Activity LEDs on these RJ-45 connectors (shown at right) indicate the status of the Ethernet connection. The green Link LED indicates that the processor is properly connected to an Ethernet LAN. This LED should light steadily. The amber ACT (Activity) LED indicates transmission of data on the connector. This LED should flicker while the Quantum communicates.



Use a CAT 5 shielded twisted pair (STP) cable to connect these ports to a computer (direct connection) or to a hub or router (indirect connection) to enable the processor to be controlled by the Quantum Control Software or to obtain image files from a QGE 100 or the Internet. Ethernet cables are limited to a length of 328 feet (100 meters).

NOTES:

- Do not use standard telephone cables. Telephone cables do not support Ethernet or Fast Ethernet.
- Do not stretch or bend the cables, because this can cause transmission errors.

You can make either a direct or an indirect Ethernet connection between the Quantum and your computer or network using the appropriate cable:

- **Crossover cable** — **Direct** connection between the computer and the Quantum processor. A 6-foot (1.8 meters) crossover cable is provided with the Quantum.
- **Straight-through (patch) cable** — **Indirect** connection between the Quantum processor and an Ethernet LAN via a router, hub, or QC 101 controller

For more detailed information on these two types of connections, see [Direct and indirect connections](#) on page 24.

The Ethernet cable must be properly terminated for your application as either a crossover or a straight-through cable. Figure 41 shows how to wire the Ethernet connector for each connection type.

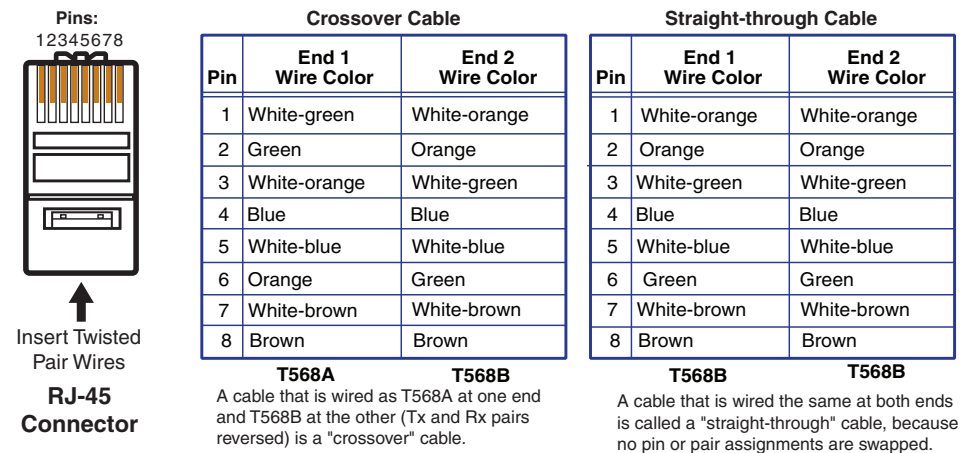

Figure 41. RJ-45 Connector Wiring

Front Panel Features

Each Quantum front panel is covered by an access panel, or door, which you unlatch in order to reach most of the front panel features.

Quantum Elite 615 Front Panels

Access panels — Quantum Elite 615

The Quantum Elite 615 front panel is covered by two access panels. The upper access panel covers the four fan modules. The lower access panel covers the rest of the front panel features (see [Front panel — Quantum Elite 615](#) on the next page).

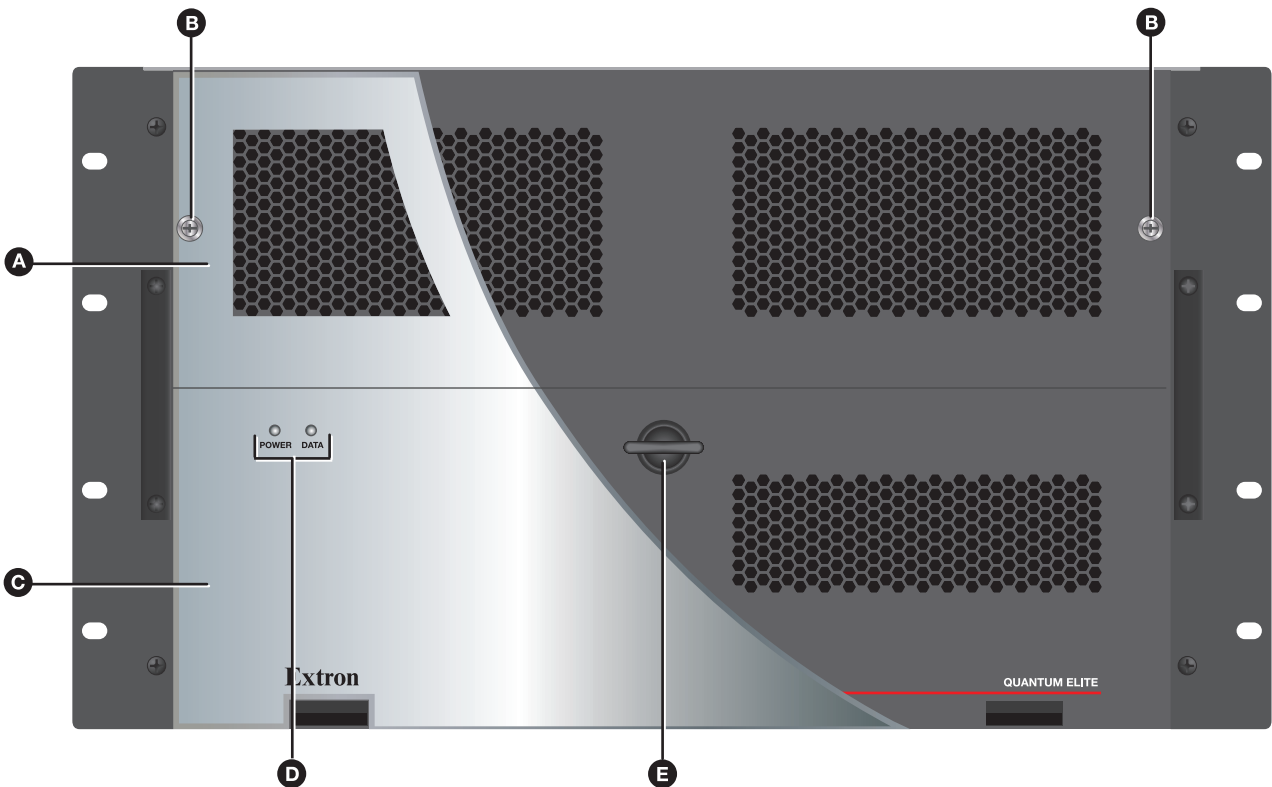

Figure 42. Quantum Elite 615 Access Panels

- A Upper access panel** — Covers the top section of the front panel, which contains the four fan modules.
- B Thumbscrews** — Loosen these screws by hand or using a screwdriver in order to lift the upper access panel and reach the fan modules.
- C Lower access panel** — Covers the bottom section of the front panel, which contains the card frame Power switch, the indicator LEDs, the flash drive, and the power supply units (PSUs).
- D LED windows** — Holes through which the Power and Data LEDs, which are attached to the front panel, can be seen when the lower access panel is closed.
- E Lower panel latch** — Releases the lower access panel. Rotate this latch one-quarter turn to the left, then grasp it firmly and pull outward to access the lower front panel.

Front panel — Quantum Elite 615

The following front panel features are located behind the upper and lower access panels.

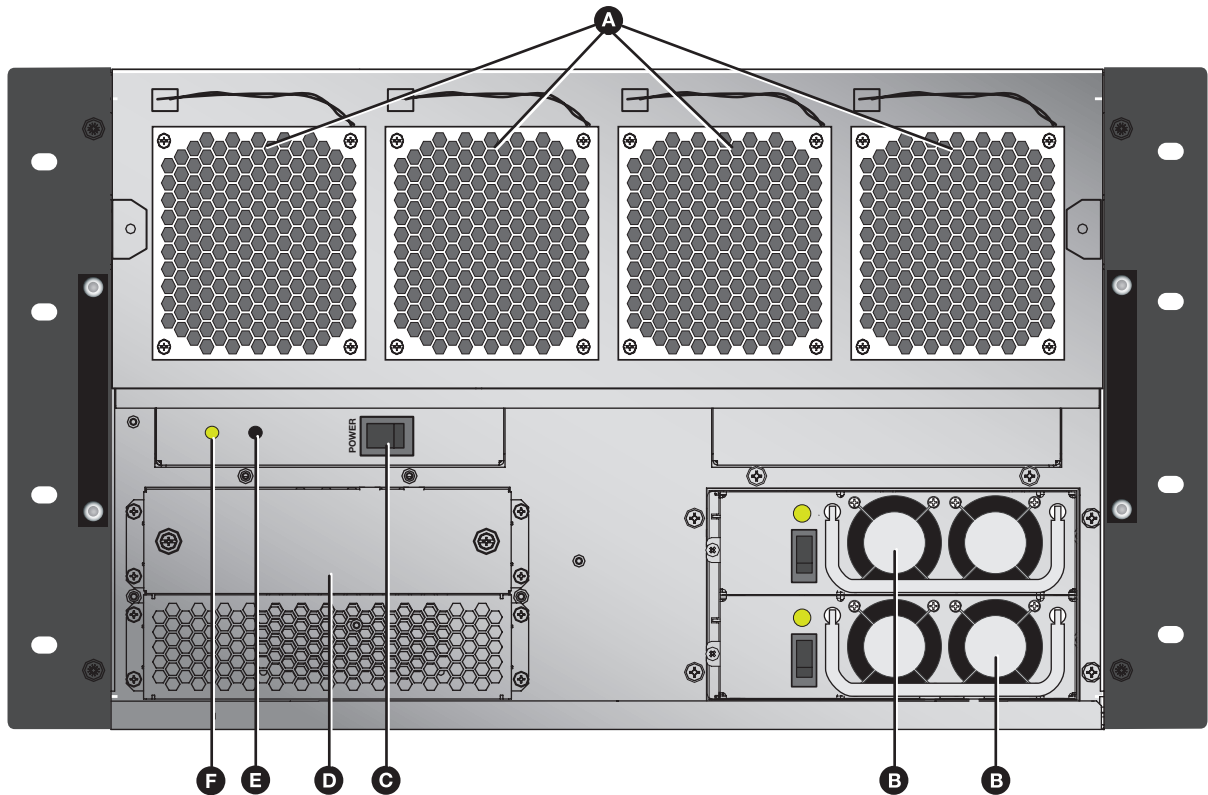

Figure 43. Quantum Elite 615 Front Panel

- | | |
|------------------------------------|------------------------------|
| A Fans | D Flash drive bay |
| B Power supply units (PSUs) | E Data LED |
| C Power switch | F Power indicator LED |

- A Fans** — These four cooling fans, located behind the upper access panel, provide forced-air ventilation, drawing air in through the upper access panel and exhausting via the rear panel vents. The fan modules are hot-swappable — if a fan fails, it can be replaced while the unit is powered on (see [Replacing a fan](#) on page 57).

These fans may need to be cleaned periodically (see [Cleaning Ventilation Grilles and Filters](#) on page 57).

ATTENTION:

- If a fan fails, replace it as soon as possible to avoid overheating.
- Si un ventilateur tombe en panne, remplacez-le dans les plus brefs délais afin d'éviter la surchauffe.

- B Power supply units (PSUs)** — These two removable power supplies operate in a redundant configuration. They are hot-swappable — if one fails, it can be replaced while the processor is operating (see [Replacing a power supply \(Quantum Elite 615 only\)](#) on page 58). Each PSU has a Power rocker switch that powers the PSU on and off. It is not necessary to turn these switches to Off when you power off the processor.

ATTENTION:

- **Both** power supplies must be powered on at all times during operation of the processor.
- If a power supply fails, replace it as soon as possible.
- Les deux alimentations doivent être allumées en permanence pendant l'utilisation du processeur.
- Si l'une des alimentations tombe en panne, remplacez-la dans les plus brefs délais.

- C Power switch** — This rocker switch powers the processor on and off.

ATTENTION:

- If your Quantum processor front panel contains a black rectangular **Reset** button (located directly below the Power switch), **do not** press it. Doing so could damage the operating system.
- Si la face avant de votre processeur Quantum dispose d'un bouton de réinitialisation rectangulaire noir (situé juste en dessous de l'interrupteur d'alimentation), n'appuyez pas dessus. Cela pourrait endommager le système d'exploitation.

- D Flash drive bay** — This dual slot flash drive bay contains the following cards:

- **Drive C: (top slot)** — Stores the operating system and hardware drivers.
- **Drive D: (bottom slot)** — Stores system configuration data. This card can also be used to store local source content, such as an image file containing a background for the target display.

You can manage the contents of drive D: using the Control Panel (see [Using the Control Panel](#) on page 61).

- E Data LED** — This amber LED blinks when data is being written to or read from drive D.
- F Power indicator LED** — This bicolor LED lights **green** when the unit is powered on and both power supplies are functioning. It lights **red** when a power supply has failed.

Quantum Elite 408 and Quantum Connect Front Panels

Access panel — Quantum Elite 408 and Quantum Connect

The access panel is a door that covers and protects the items on the front panel of the Quantum Elite 408 and of the Quantum Connect.

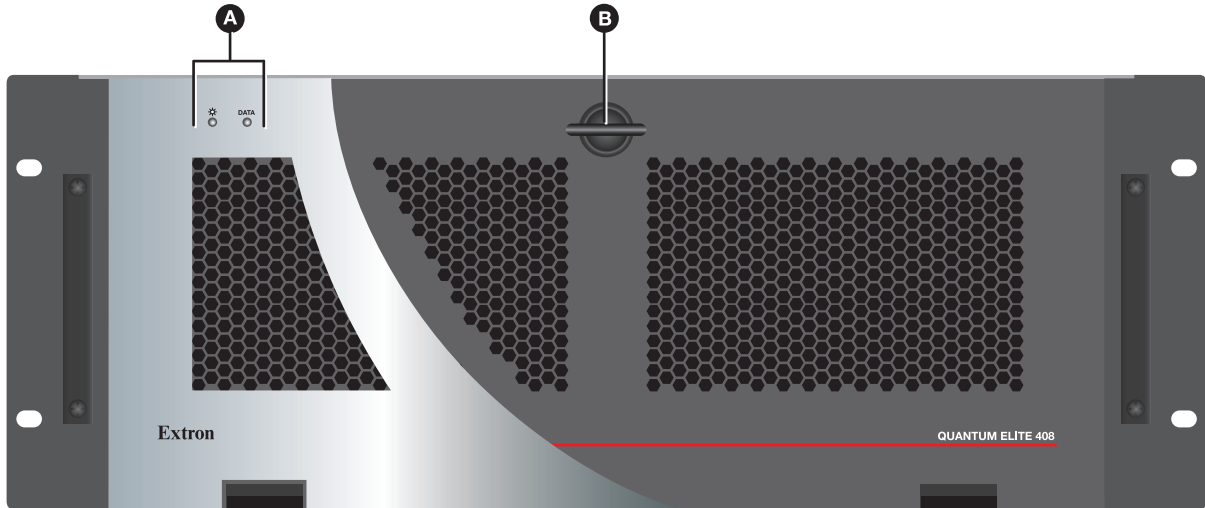

Figure 44. Quantum Elite 408 Access Panel

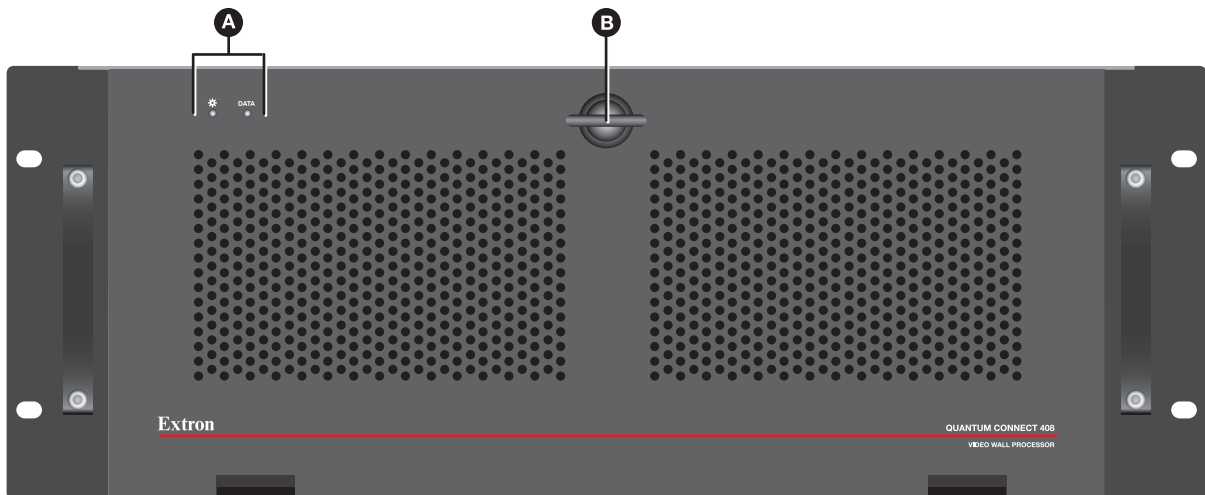

Figure 45. Quantum Connect Access Panel

- A LED windows** — Holes through which the Power and Data LEDs, which are attached to the front panel, can be seen when the access panel is closed.
- B Panel latch** — Releases the access panel. Rotate this latch one-quarter turn to the left, then grasp it firmly and pull outward to access the front panel.

Front panel – Quantum Elite 408 and Quantum Connect

The following front panel features are located behind the access panel:

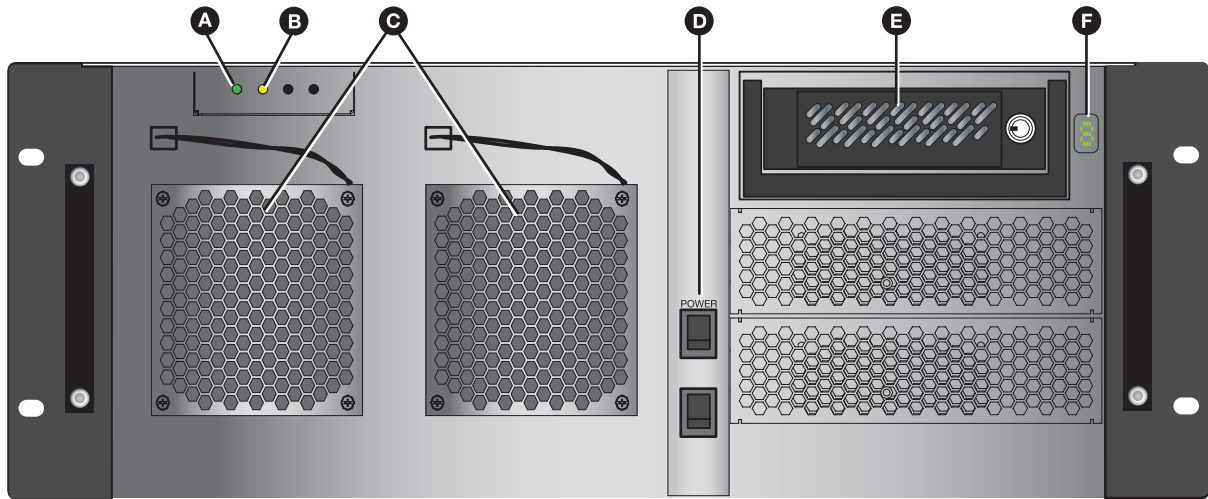

Figure 46. Quantum Elite 408 and Quantum Connect Front Panel

- A Power indicator LED** — This green LED lights when the unit is receiving power.
- B Data LED** — This amber LED blinks when data is being written to or read from the hard disk drive.
- C Fans** — These two cooling fans provide forced-air ventilation, drawing air in through the access panel and exhausting via the rear panel vents. The fan modules are hot-swappable — if a fan fails, it can be replaced while the unit is powered on and operating (see [Replacing a fan](#) on the next page). These fans may need to be cleaned periodically (see [Cleaning Ventilation Grilles and Filters](#) on the next page).

ATTENTION:

- If a fan fails, replace it as soon as possible to avoid overheating.
- Si un ventilateur tombe en panne, remplacez-le dans les plus brefs délais afin d'éviter la surchauffe.

- D Power switch** — This rocker switch powers the unit on and off.
- E Hard disk drive** — This 80 GB IDE disk drive is located in a removable caddy that is locked in position by a supplied key. The drive is partitioned as follows:

- **Drive C:** Contains the operating system.
- **Drive D:** Contains system configuration and image files.

You can manage the contents of the D drive using the Control Panel (see [Using the Control Panel](#) on page 61).

- F LCD window** — Displays a 0 that blinks while the system is powering up. When the Quantum is completely powered up, the 0 in this window remains lit steadily.

ATTENTION:

- If your Quantum processor front panel contains a black rectangular **Reset** button (located directly below the Power switch), **do not** press it. Doing so could damage the operating system.
- Si la face avant de votre processeur Quantum dispose d'un bouton de réinitialisation rectangulaire noir (situé juste en dessous de l'interrupteur d'alimentation), n'appuyez pas dessus. Cela pourrait endommager le système d'exploitation.

Maintenance

Cleaning Ventilation Grilles and Filters

The front ventilation grilles and air filters should be checked periodically for dust buildup. Excess dust deposits reduce the efficiency of the cooling fans and can cause the unit to overheat.

To clean the grilles and filters, use a vacuum cleaner and, if necessary, a soft brush to remove any dust.

Removing and Replacing Components

The fan modules on all Quantum models and the power supply modules on the Quantum Elite 615 can be replaced if they should fail. These modules are hot-swappable, which means that they can be replaced while the unit is powered on and operating.

Replacing a fan

To replace a cooling fan module:

1. Open or remove the front access panel:
 - **Quantum Elite 615:** Loosen the two screws on the top access panel and remove the panel.
 - **Quantum Elite 408 and Connect:** Rotate the latch on the access panel one-quarter turn counterclockwise and pull outward on it to lower the panel.
2. Unplug the fan power cord:
 - a. Press the retaining clip, located on the right side of the fan power cord plug, inward.
 - b. Pull the plug out of the fan power connector.
3. Loosen the single screw from the top of the fan module.

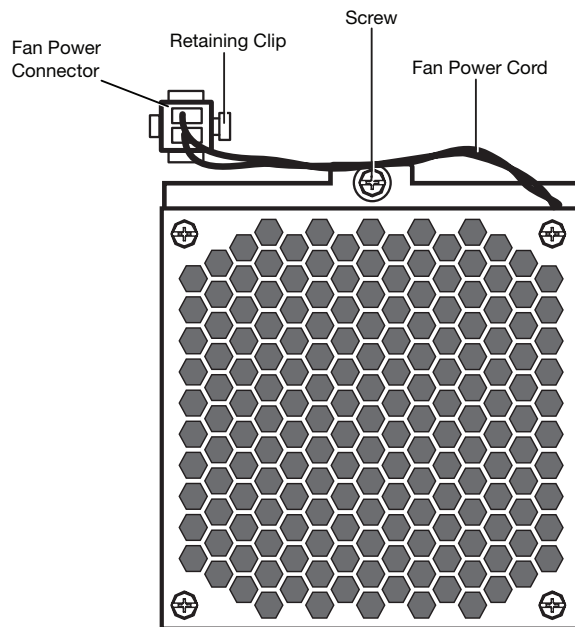

Figure 47. Removing a Fan Module

4. Tilt the top of the fan forward, then lift the module up and out of its housing.
5. Place the new fan into the housing by inserting the two tabs at the bottom of the fan module into the two slots at the bottom of the opening and tilting the top of the fan back into the unit.
6. Press the top of the fan back into place.
7. Tighten the screw.
8. Plug the fan power cord into the connector, ensuring that the clip is on the **right** side of the connector.

Replacing a power supply (Quantum Elite 615 only)

If a power supply unit (PSU) fails on the Quantum Elite 615, an audible alarm is triggered, and the front panel Power LED lights red. In addition, the green status LED above the PSU power switch is extinguished.

NOTE: The alarm also sounds when a functioning PSU is disconnected or powered off.

To remove and replace a PSU:

1. Rotate the latch on the lower access panel one-quarter turn counterclockwise and pull outward on it to lower the panel.
2. Use a small screwdriver to remove the retaining screw at the left of the failed PSU.

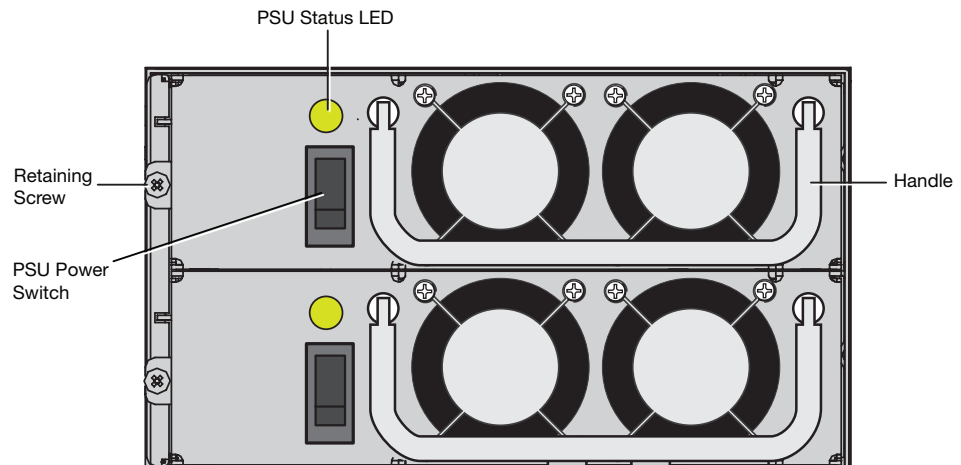

Figure 48. Power Supply Units on the Quantum Elite 615

3. Lift and pull out the metal handle on the PSU until the power supply comes free.
4. Insert the new PSU and press it firmly into place.

ATTENTION:

- Ensure that the switch on the new PSU is in the Off position before installing it.
- Assurez-vous que l'interrupteur situé sur la nouvelle alimentation est en position Off avant de l'installer.

5. Replace the retaining screw.
6. Switch on the new PSU and check that its status LED is lit.

Operation

When all sources, displays, and the computer or other controlling device have been connected to the cards in the card frame and set up as needed via the Control Panel and Quantum Control Software, the Quantum system is fully operational.

While the processor is operating, you can continue to create and revise layouts, scenes, and window parameters using the Quantum Control Software (see the *Quantum Control Software User Guide* for the procedures). You can also change the settings available through the Control Panel.

This section describes the functions you can perform while the system is operating. The following topics are covered:

- **Powering On and Off**
- **Using the Control Panel**
- **Accessing the Quantum Control Software**

Powering On and Off

Powering on

Before powering on the system, ensure that the provided power cord is connected between the Power connector on the Quantum rear panel and an AC source.

- **Quantum Elite 615:**
 1. Unlatch and open the lower access panel.
 2. Set the vertical Power rocker switches on both power supply units to **I** (On).
 3. Set the horizontal Power rocker switch to **I**.

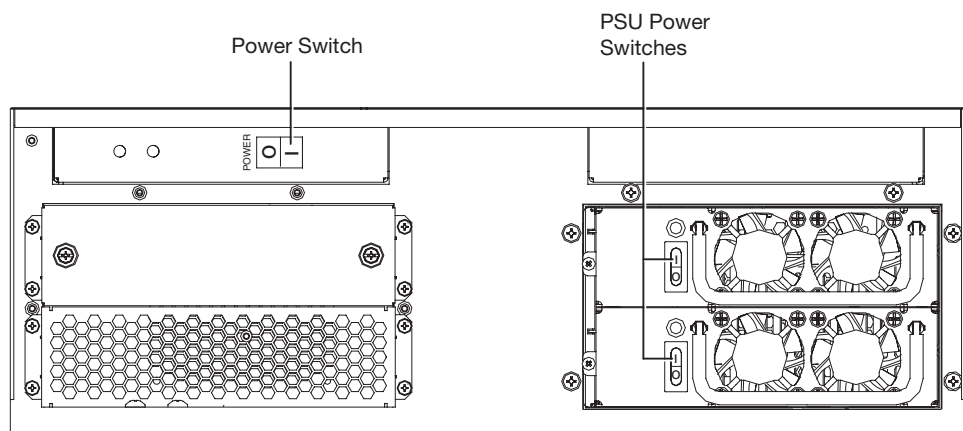

Figure 49. Power Switches on the Quantum Elite 615 Front Panel

- **Quantum Elite 408 and Quantum Connect:**

1. Unlatch and lower the front access panel.
2. Press and release the bottom section of the front panel vertical Power rocker switch.

While the system is powering up, the 0 in the LCD window to the right of the hard drive blinks. When the processor is completely powered up, the LCD stops blinking and remains lit steadily.

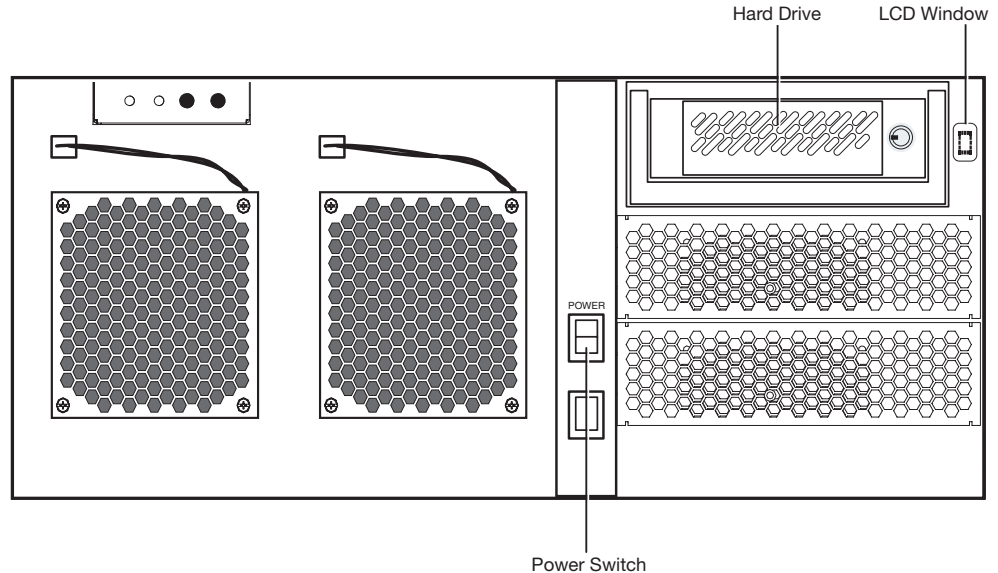

Figure 50. Power Switch on the Quantum Elite 408 and Quantum Connect

If a keyboard, mouse, and monitor are connected to the Quantum, the Control Panel boots up. When the system is completely powered up, the Control Panel screen is displayed.

Powering off

If the Control Panel is not being used, turn off power to the Quantum processor as follows:

- **Quantum Elite 615:** Press the O section of the horizontal Power rocker switch.

NOTE: It is not necessary to turn off the switches on the two PSUs. They can remain set to On.

- **Quantum Elite 408 and Quantum Connect:** Press and hold the bottom section of the Power rocker switch until power is off.

TIP: If a monitor is connected to the Quantum and is displaying the Control Panel, shut down the processor via the Control Panel (see [Shutting Down Using the Control Panel](#) on page 66).

Using the Control Panel

The Quantum processor is a host device with Microsoft Windows XP embedded. The Quantum Control Panel is a Windows-based program that is resident on the Quantum internal disk or flash drive and enables you to perform various setup tasks, such as setting the processor IP address or updating its firmware.

Starting the Control Panel

To access the Quantum Control Panel:

3. Ensure that the Quantum is powered down.
4. Connect a PS/2 or USB keyboard and mouse to the USB or mini-DIN connectors on the Quantum rear panel (see [Keyboard, Mouse, Monitor, USB, and Media Cards](#) on page 46).
5. Connect a monitor to the 15-pin VGA connector on the rear panel Media I and II card (Quantum Elite 615) or Keyboard and Mouse card (Quantum Elite 408 and Quantum Connect).
6. Power on the processor. The Quantum introductory screen appears on the monitor. This screen displays the name and a photograph of a Quantum processor.
7. On the Quantum keyboard, hold down the <Ctrl> key while pressing <F2>. The Control Panel main window opens.



Figure 51. The Quantum Control Panel Main Window

8. Click one of the buttons at the bottom of the screen to proceed to the desired task (see [Control Panel Buttons](#) on the next page).

To close the Control Panel window, click **C**lose in the upper-right corner.

Control Panel Buttons

The following buttons give you access to setup and other functions via the Control Panel:

- **Service Mode** — Enables you to access service mode, in which you can load image files onto the processor hard drive or flash drive (see “Loading Image Files (Quantum Elite Models Only,” below).

NOTES:

- When you click this button, a password prompt appears. Enter **bostonxpe** (all lowercase letters), then click **OK**.
 - The factory configured passwords for all accounts on this device have been set to the device serial number. In the event of an absolute system reset, the passwords convert to the default, which is no password.
- **Network Settings** — Displays the Network Settings window, from which you can view or change the IP address and other parameters of the rear panel Control port. On the Quantum Elite models, you can also set network parameters for the Media I and Media II ports, which are used for streaming QGE 100 sources.
 - **Compact Flash** — Lets you write-protect the flash drive (Elite 615) or the hard drive (Quantum Elite 408 and Quantum Connect). You can also save the network settings, I/O card arrangement, and so on, to the Windows XP embedded configuration.
 - **Default Setup** — Resets the processor to its factory default settings.
 - **Install Software** — Enables you to update the Quantum firmware on your unit.
 - **Shutdown** — Reboots or shuts down the Quantum system.

Loading Image Files (Quantum Elite Models Only)

You can upload image files from an external USB drive to the Quantum processor to be displayed as sources on the screen and incorporated into presentations. The following image file types are supported:

- Bitmaps (.bmp)
- JPEG (Joint Photographic Experts Group) images (.jpg)
- Graphics Interchange Format bitmaps (.gif)
- Portable Network Graphics (.png)

To upload image files to the Quantum hard drive or flash drive:

1. Connect the external USB drive containing the images to one of the rear panel USB ports.
2. On the Quantum Control Panel window, click **Service Mode**.
3. On the password prompt window that opens, enter **bostonxpe**, then click **OK**. The **Control Panel** window is minimized and an **RtxServer** log window appears. Close or minimize this window.

NOTE: The factory configured passwords for all accounts on this device have been set to the device serial number. In the event of an absolute system reset, the passwords convert to the default, which is no password.

4. Click the **Start** button in the lower-left corner of the screen. The **System** window opens.
5. On the **System** window, click **My Computer**. The Quantum computer drive window opens.

6. From the **Address** drop-down menu, select **External Drive [X]** for the drive containing the image files to be loaded (usually the **E:** drive).
7. Copy or move the image files to the **Pictures** folder on the Quantum **D:** drive. The files can now be accessed via the Quantum Control Software for use in presentations (see the *Quantum Control Software User Guide* for information on creating presentations).

Changing Network Settings

To change the IP addresses of the Control and Media ports:

1. On the Control Panel window, click **Network Settings**.
2. On the Network Settings window, select the port to configure from the **Select Network Connection** drop-down menu.

NOTE: On the Quantum Connect, the only port that can be selected from this menu is the Control port.

3. Enter the new IP addresses in the following sections as desired:
 - **IP Settings section:** Enter any changes in the **IP Address**, **Subnet Mask**, and **Default Gateway** address fields; **or** select the **DHCP Enabled** check box to specify automatic assignment of these addresses.
 - **Machine Name:** If desired, enter a name of 1 to 15 characters for your Quantum processor. Only letters, numbers, and the hyphen (-) can be used in the name.
 - **DNS Settings:** Enter any desired changes in the **Primary DNS Server IP** and the **Secondary DNS Server IP** address fields; **or** select the **DHCP Enabled** check box to specify automatic detection of these addresses.
 - **Windows Internet Name Service (WINS) Settings:** Enter any desired changes in the **WINS Server IP** and the **Secondary WINS Server IP** address fields.
4. Click **OK**.

Updating Firmware

If it becomes necessary to update the firmware on your Quantum processor, Extron provides you with the firmware file (not available on the Extron website). Upload this file, named **BostonCoreComponents_vn.nn.exe** (where **vn.nn** is the firmware version number), to the unit as follows:

1. Copy the new firmware file to an external USB drive and plug the drive into one of the Quantum rear panel USB ports.

2. On the Quantum Control Panel window, click the **Install Software** button.

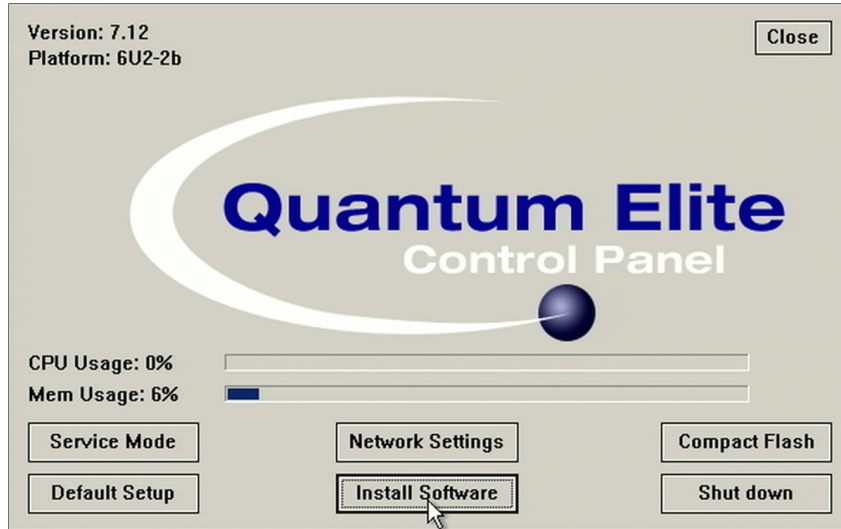

Figure 52. Install Software Button on the Control Panel Window

3. On the Install Software window, select **Install Software**, then click **OK**.



Figure 53. Install Software Window

4. On the **Open** window that appears, navigate to **My Computer**.
5. Double-click on **External [X]** drive for the drive containing the firmware executable file (usually drive E:).
6. Double-click the firmware file name, ending with **.exe**, to start the installation process.

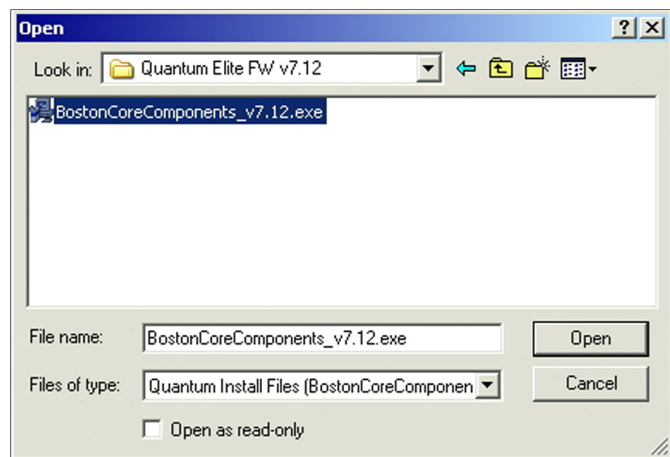

Figure 54. Open Window for Firmware File Selection

While the firmware file is uploading, the Installing screen shows the progress of the firmware installation.

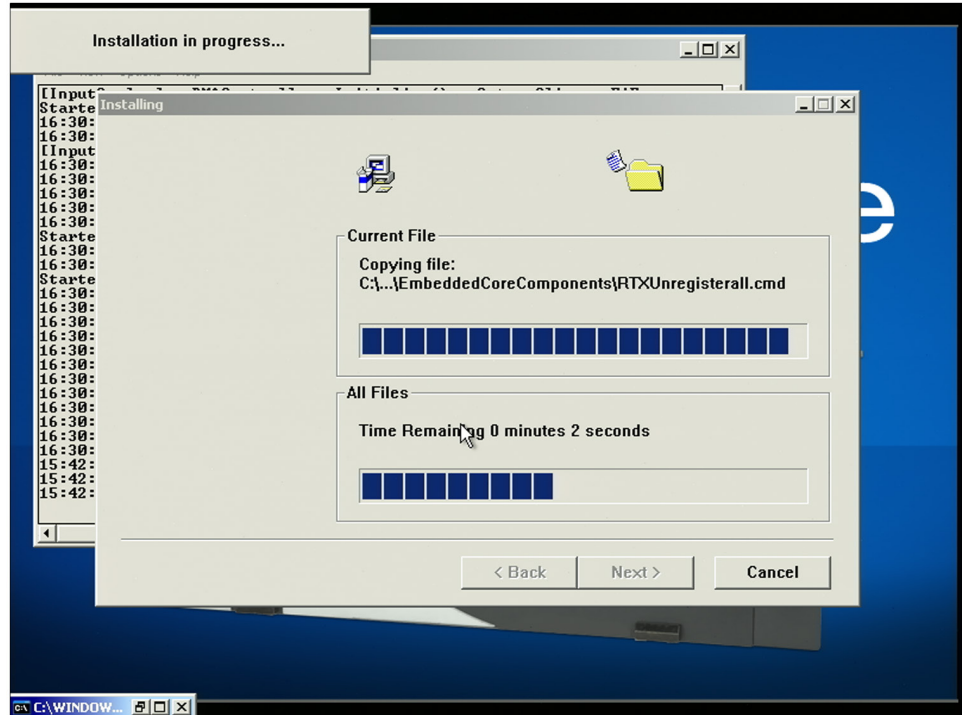

Figure 55. Firmware File on the Control Panel Quantum D Drive

When the installation is complete, a message appears, notifying you that the processor is rebooting.

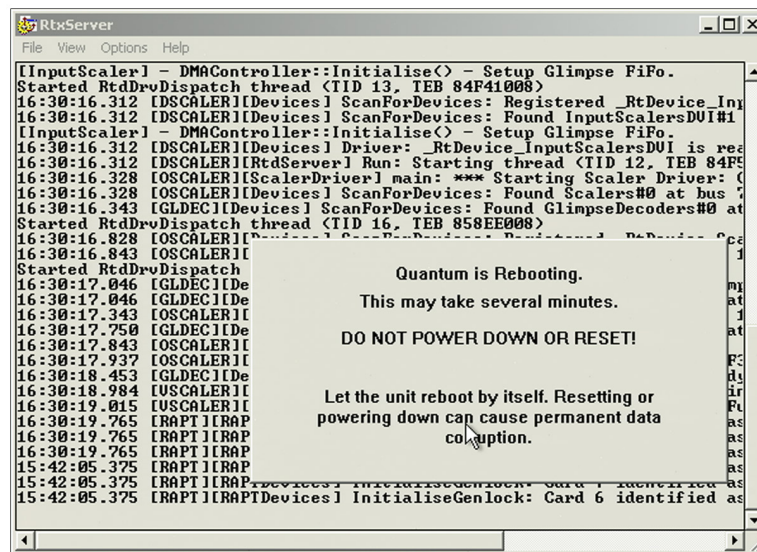

Figure 56. Rebooting Message

ATTENTION:

- Wait until the opening screen appears before performing any other operations.
- Attendez jusqu'à ce que l'écran d'accueil apparaisse avant d'effectuer une quelconque opération.

Shutting Down Using the Control Panel

When a keyboard, mouse, and monitor are attached, the Quantum can be shut down via the Control Panel. There are two methods of shutting down, depending on whether or not the Quantum is in service mode for uploading stored images.

NOTE: You can also shut down the Quantum at any time by pressing the front panel Power switch (see [Powering off](#) on page 60).

Shutting down in normal mode

When the Quantum is **not** in service mode:

1. On the **Control Panel** window, click **Shut down**.
2. On the **Quantum Shutdown** window that opens, select the **Shut down** radio button, then click **OK**.
3. A message is displayed, telling you to wait until the screen is blank before powering down. After a few seconds, the processor powers off and the screen turns dark.

NOTE: If the processor does not power off, wait until the screen is blank, then press the Power switch on the front panel.

Shutting down in service mode

When the Quantum is in service mode:

1. Click **Start**, in the lower-left corner.
2. On the **System** window that opens, click **Shut Down**. The **Shut Down Windows** dialog box opens.
3. From the **What do you want the computer to do?** drop-down menu, select **Shut Down**, then click **OK**. After a few seconds, the processor and the monitor turn off.

Committing the Current Settings to Flash Memory

The Control Panel enables you to commit (save) to flash memory all the current settings, including window configuration, layouts, scenes, and so on. These saved settings remain in effect the next time the Quantum is powered on. To commit the settings to memory:

1. On the **Quantum Control Panel** window, click **Compact Flash**. The **Compact Flash Control** window opens.
2. On the **Compact Flash Control** window, click **Commit Settings to Compact Flash**.
3. A prompt window appears, telling you that the system must be rebooted for the settings to be stored and asking if you want to reboot now. Click **OK** to proceed. (To terminate this process without saving settings and rebooting, click **Cancel**.)

When you click **OK**, a prompt window appears, telling you that the Quantum is rebooting.

ATTENTION:

- While the processor is rebooting, do not press any keys or attempt to power off the system.
- Pendant la réinitialisation du processeur, n'appuyez sur aucune touche et n'essayez pas d'éteindre le système.

When the reboot is complete, the Quantum introductory screen is displayed. All the settings have been saved to memory and remain in effect until changed.

Accessing the Quantum Control Software

The Windows-based Quantum Control Software enables you to configure and control the Quantum from your computer by creating a videowall project. Use this control program to display multiple image sources on single or multiple target displays. Two different control programs are provided: one for the Quantum Elite models and one for the Quantum Connect.

NOTE: The Quantum Elite Control Software does not operate with a Quantum Connect processor or vice versa.

Some features of the Quantum Control Software include:

- The user interface is organized into a series of tasks so that you can easily navigate through them and set up the videowall.
- A virtual canvas provides an on-screen layout for the videowall where windows can be added, sized, and positioned.
- Custom videowall configurations can be saved as scenes (presets) for future recall.
- You can create a custom user interface so that the system operator can easily recall the scenes.

See the *Quantum Control Software User Guide* for details on using this software.

Computer System Requirements

For the Quantum Control Software to function correctly and reliably, it must be installed on a computer that meets or exceeds the following criteria:

	Minimum	Recommended
Operating System	Windows XP	Windows 7 or Windows 8
Processor Speed	200 MHz	450 MHz or higher
Memory (RAM)	64 MB	128 MB or higher
Hard Disk Free Space	30 MB	More than 30 MB
Graphics	1024x768, 65 K colors (16-bit)	1920x1080, 16.7 M colors (32-bit)
Network Card (Ethernet)	10Base-T	100Base-T

Installing the Software

The control software for your model is provided on a CD with your processor (it is not available for downloading from the website). To use the software to set up the Quantum displays, install the program on your computer as follows:

1. Insert the Quantum CD into the disk drive of your PC and wait for your external drive screen to open.
2. Open the folder for your Quantum product (Quantum Elite or Quantum Connect).
3. Open the **Quantum Model Name Software** folder.
4. Double-click on the file named **Quantum Elite_SetupVn.nn.exe** or **Quantum Connect_SetupVn.nn.exe**. In the file name, **n.nn** is the software version number.

The Quantum Installation wizard opens.

5. Follow the instructions on the wizard screens to complete the software installation.

Starting the Software

To start using the Quantum Control software, your computer must be connected to the RJ-45 Control connector on the Quantum rear panel (see **Control Card** on page 24).

1. Open the software program by one of the following methods:
 - Double-click the **Quantum Elite** or **Quantum Connect** icon that was placed on the desktop during installation.
 - From the desktop, click **Start > All Programs > Extron Electronics > Quantum Elite** (or **Connect**) > **Quantum Elite** (or **Connect**).

The Quantum Control Software splash screen appears for a few seconds, followed by the main application window.

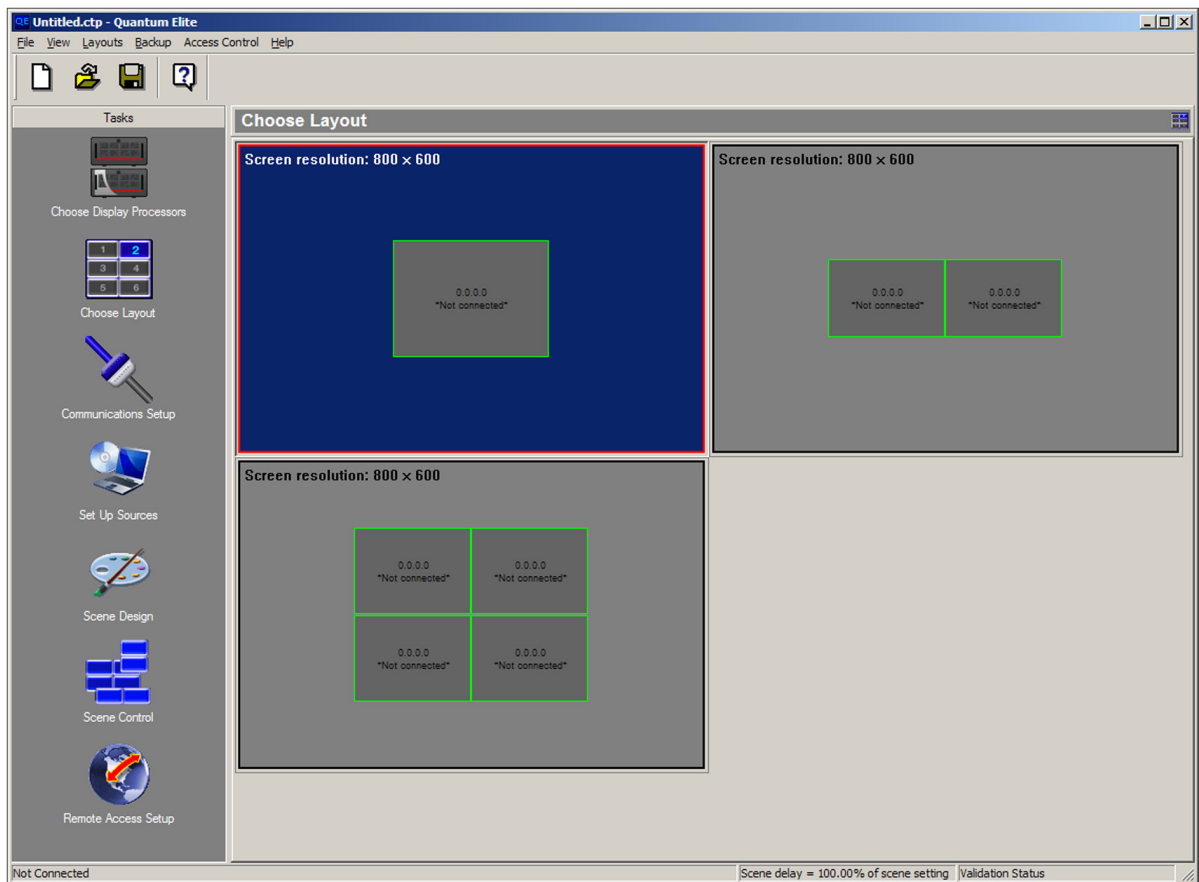

Figure 57. Quantum Main Application Screen

2. By default, the Choose Layout screen is displayed; however, you can display other screens by clicking the task icons in the left column.

Proceed to start a project (see the *Quantum Control Software User Guide* for all procedures).

QC 101 Controller

This section describes the optional QC 101 Controller and provides instructions for connecting it and using it with the Quantum processors. Topics include:

- [Overview of the QC 101](#)
- [Installation and Connections](#)
- [Connecting for RS-232 Control](#)
- [Configuring the QC 101](#)
- [Front Panel Indicators](#)

Overview of the QC 101

The QC 101 Controller is a dedicated controller for the Quantum processor. It features an embedded operating system residing on a write-protected drive partition and the Quantum Control Software preinstalled on the internal drive. When connected to a Quantum and a control device such as an Extron IP Link Pro control processor, the QC 101 can serve as an alternative to a traditional PC to create configurations and link the Quantum processor to a control system via RS-232.

Two models are available: QC 101 E for Quantum Elite models and QC 101 C for the Quantum Connect. The QC 101



Figure 58. QC 101 Controller

Using the Quantum Control Software, you can create configurations on the QC 101 itself or on a standard PC and migrate them to the QC 101. Connect a display, keyboard, and mouse to the QC 101 for setup and configuration, then remove them after the system is set up.

No driver or software installation is necessary, and the QC 101 automatically launches the Quantum Control Software when powered up. Through Ethernet, the QC 101 can be connected to a single Quantum Connect or Quantum Elite processor, or networked with up to eight Quantum Elite units in a large videowall system. A standard RS-232 port provides direct connection into a control system. The QC 101 Controller can be rack or furniture mounted.

Installation and Connections

QC 101 Rear Panel Connections

The rear panels of the QC 101 E and the QC 101 C are identical except for a label indicating the model (QC 101 E or QC 101 C).

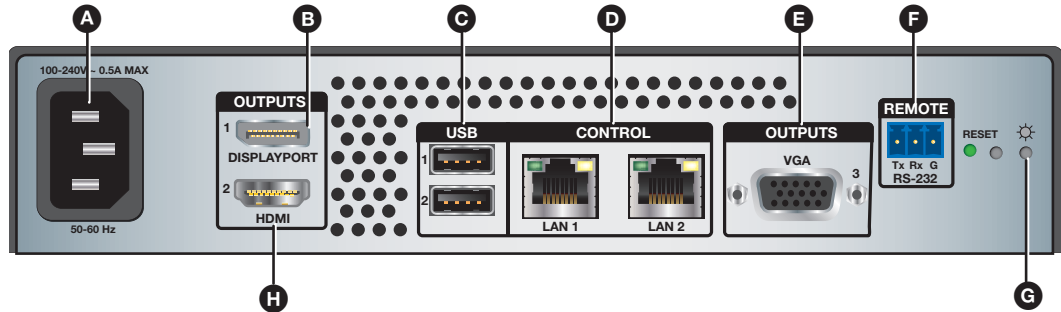

- A AC power connector**
- B DisplayPort output connector**
- C USB connectors**
- D LAN connectors**
- E VGA output connector**
- F Remote RS-232 connector**
- G Power button**
- H HDMI output connector**

Figure 59. QC 101 Rear Panel

- A AC power connector** — Connect the supplied IEC power cord between this male IEC connector and an AC power source.
- B DisplayPort output connector** — (Optional) Connect an external display that supports DisplayPort to this connector for use when configuring a Quantum processor using the Quantum Configuration Software.
- C USB connectors** — Connect a mouse and keyboard (or a keyboard and mouse combination), and a flash drive (if needed), to these two connectors to create and save Quantum Elite or Connect configuration project files (see the *Quantum Control Software User Guide*, available at www.extron.com for details on using the Quantum Configuration Software).
- D LAN connectors** — These two RJ-45 connectors support 10/100/1000 Base-T. Connect either of these ports to a LAN or directly to the Control connector on a Quantum chassis to enable communication with the processor.

NOTE: The QC 100 must be connected to the same subnet as the Quantum processors.

- E RGBHV output connector** — (Optional) Connect an RGB display to this 15-pin VGA connector for use when configuring the system using the Quantum Configuration Software.
- F Remote RS-232 connector** — Connect a control system (such as an Extron IPCP or IPL Pro Control Processor) to this 3-pole captive screw connector for remote control of the videowall via RS-232 (see the *Quantum Control Software User Guide* for the commands).
- G Power button** — Using a small screwdriver or stylus, press this recessed button momentarily to safely shut down the controller. Pressing and holding the button for 5 seconds forces a hard shutdown of the QC 101.

- H HDMI output connector** — (Optional) Connect an external display that supports HDMI to this connector for use when configuring a Quantum processor using the Quantum Configuration Software.

NOTE: The LED and recessed button labeled **Reset** are not functional on this product.

Installation Overview

Follow these steps to install and set up the QC 101 to control a Quantum videowall system:

1. Disconnect power from all equipment.
2. (Optional) Mount the unit to a rack or furniture, following the instructions provided with the mounting hardware (see **Mounting the QC 101** on page 80).
3. Connect a display to the VGA, HDMI, or DisplayPort output connector (see **figure 59**, **B**, **E**, or **H** on the previous page) to use while creating configuration projects for the Quantum.
4. Connect the keyboard and mouse (or a keyboard and mouse combination) to one or both of the USB connectors (see **figure 59**, **C**) to use while creating configuration projects using the Quantum Control Software. If desired, connect a flash drive to either USB port to store the projects you create.
5. Connect a straight-through Ethernet cable between one of the QC 101 LAN ports (see **figure 59**, **D**) and the network or the Quantum rear panel Control connector. If connecting through a LAN, ensure that the QC 101 and all Quantum processors are on the same subnet. See **Ethernet Connections** on page 51 for information on wiring Ethernet cables.
6. Connect a control device (such as an Extron IPL Pro control processor) to the Remote RS-232 port (see **figure 59**, **F**) for remote control of the Quantum system via R-type commands. See **Connecting for RS-232 Control** on page 72 to connect to this port. See the *Quantum Control Software User Guide*, available at www.extron.com, for a list and description of the available R-type commands.
7. Connect AC power to the QC 101 rear panel IEC connector. Connect power to all other devices in the system.
8. Power on the Quantum chassis and all other connected devices.

Connectivity Options

Using a straight-through cable, you can connect the QC 101 to a Quantum processor by either of the following methods:

- Directly from a QC 101 LAN port to the Quantum Control connector on the rear panel (see figure 60).

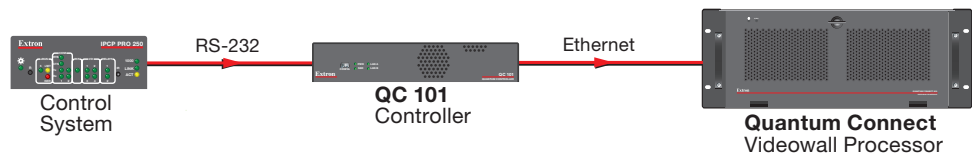

Figure 60. QC 101 Direct Connection

- Indirectly from a QC 101 LAN port to the network to which the Quantum processors are connected (see figure 61). One to eight Quantum processors can be connected to the QC 101 simultaneously. The QC 101 and all connected processors must be on the **same subnet**.

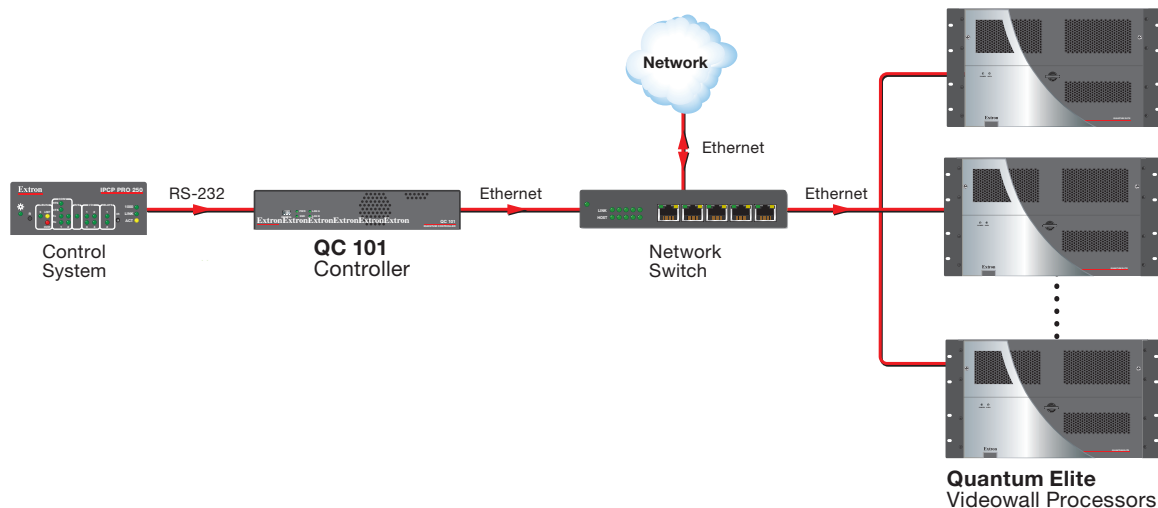

Figure 61. QC 101 Indirect (Network) Connection

Connecting for RS-232 Control

To send control commands to the Quantum processor via the QC 101 controller, connect a control device (such as the Extron IPL Pro or IPCP Pro control processors) to the Remote RS-232 port on the QC 101 rear panel (see [figure 59](#), **F**, on page 70).

To connect a control system to the QC 101 RS-232 port:

1. If the provided 3-pole captive screw connector is not already plugged into the RS-232 port on the rear panel, attach it.
2. Wire an unterminated RS-232 cable to the attached 3-pole captive screw connector as follows:
 - a. Connect the transmit wire to the left pin, which plugs into the Tx (transmit) port.
 - b. Connect the receive wire to the middle pin, which plugs into the Rx (receive) port.
 - c. Connect the ground wire to the last pin, which plugs into the ground port, marked with G.
3. Connect the other end of the RS-232 cable to the serial (Com) port of the control processor.

See [figure 62](#) on the next page.

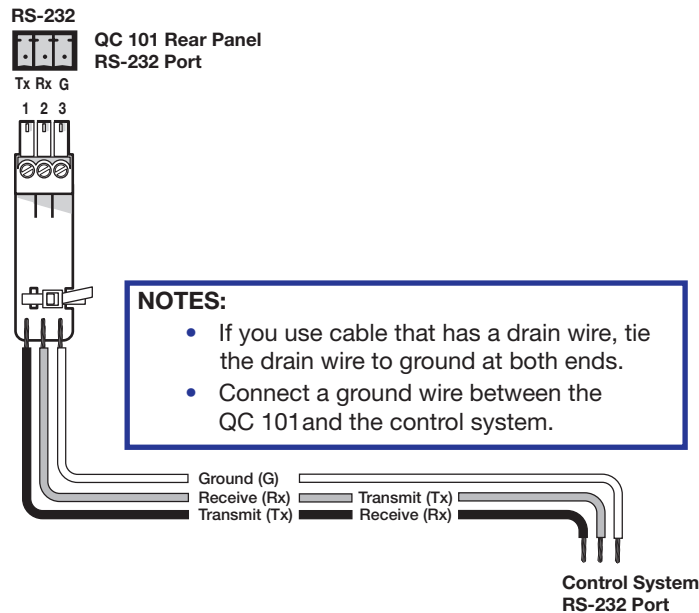

Figure 62. Connecting to the RS-232 Port

Configuring the QC 101

After you have made all necessary connections, you are ready to configure the QC 101 to control the Quantum processor as follows:

1. Set the IP address (see [Setting the QC 101 IP Address](#)).
2. Start a Quantum project using the Quantum Control Software. See [Accessing the Quantum Control Software](#) on page 67 to load the software. See the *Quantum Control Software User Guide*, available at www.extron.com, to create a project.
3. Configure the RS-232 connection (see [Configuring the RS-232 Connection](#) on page 76).

Setting the QC 101 IP Address

The QC 101 controller is a host device with an embedded operating system. To communicate with the Quantum processor, the QC 101 must be on the same network and subnet as all the Quantum processors in the system. To set the QC 101 IP address, you need a keyboard and mouse connected to one or both of the USB ports and a monitor connected to one of the output ports.

1. Do either of the following:
 - On the QC 101 **Start** screen, click the **Network Connections** icon (shown at right), or
 - On the desktop screen, double-click the **Network Connections** shortcut icon on the desktop.



The **Network Connections** window opens.

2. On the Network Connections window, right-click the name of the LAN port currently in use.

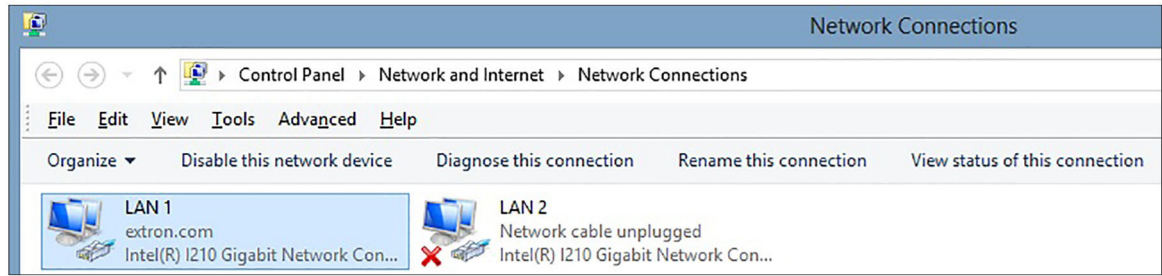

Figure 63. Selecting a LAN Port

3. From the LAN pop-up menu, select **Properties**.
4. On the LAN properties dialog box, scroll to locate and select the **Internet Protocol Version 4 (TCP/IPv4)** checkbox (see figure 63, ①), and click the **Properties** button (②).

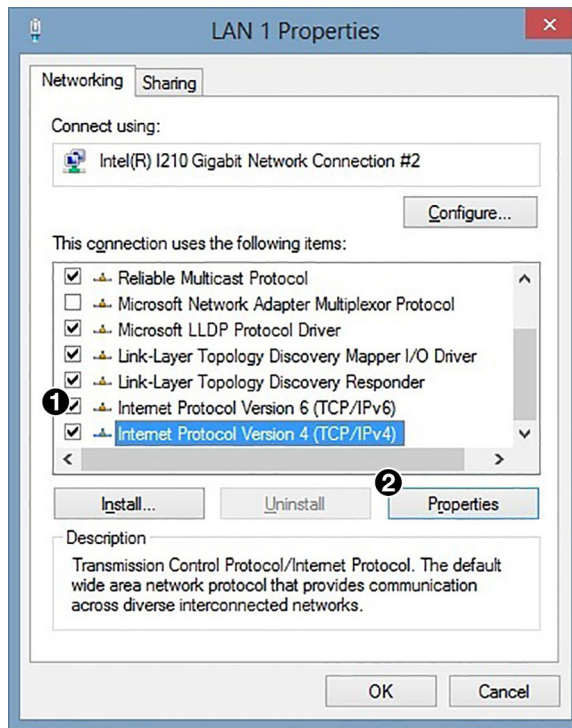
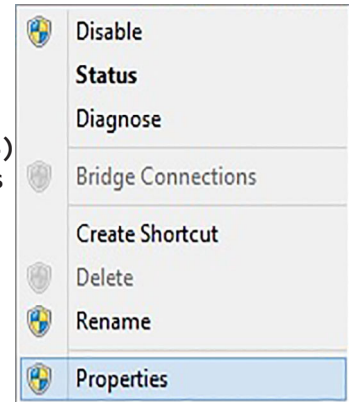

Figure 64. LAN Properties Dialog Box

5. In the Internet Protocol Version 4 (TCP/IPv4) Properties dialog box, enter the desired IP address parameters and click **OK**. The IP address must be on the **same subnet** as those of the Quantum processors.

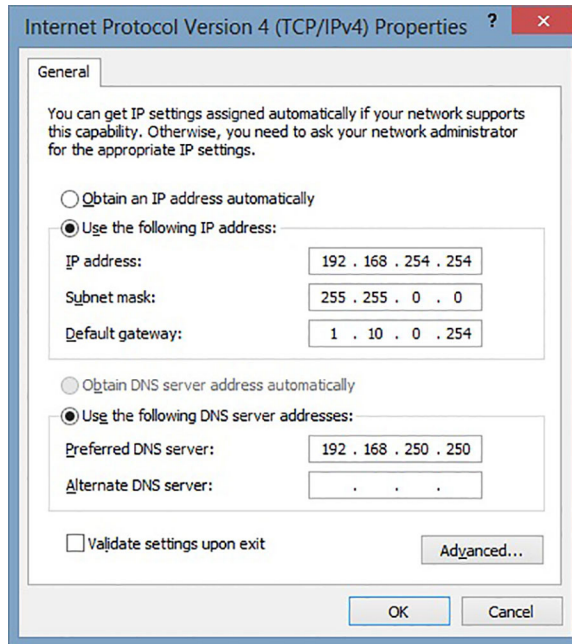

Figure 65. Internet Protocol Version 4 (TCP/IPv4) Properties Dialog Box

6. In the QC 101 Shell window, click the **Commit C Drive** button (see figure 65, ①).

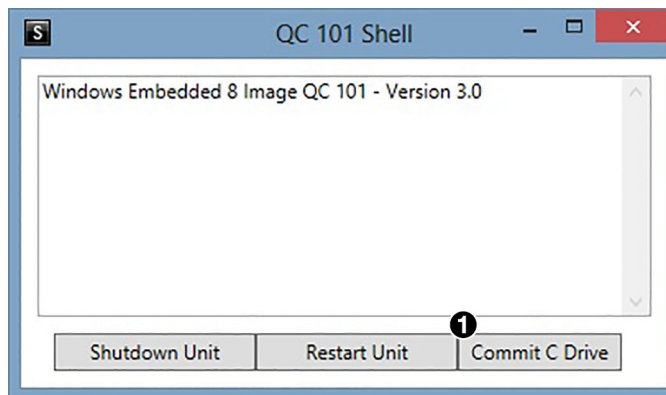

Figure 66. Commit C Drive Button on the QC 101 Shell Window

7. On the confirmation prompt that opens, click **OK** to save the address changes to the hard drive and reboot the controller.

Configuring the RS-232 Connection

To set up the RS-232 connection between the QC 101 and a control system:

1. Create a new project or upload an existing one.
 - **If creating a new project**, see the *Quantum Control Software User Guide* for detailed instructions. Save the project to the QC 101 D: drive.

NOTE: The C: drive on the QC 101 is write-protected. Therefore, content on the C: drive that is created or changed is not saved when power is cycled to the QC 101. Save any new or changed projects on the controller to the D: drive or to a flash drive attached to one of the USB ports on the QC 101 rear panel.

- **If uploading an existing project** that was created on a PC, copy the project file directly to the QC 101 D: drive and double-click its filename to open the project.
2. Test presets and input switching within the Quantum Control Software to ensure that the project is satisfactory.

3. Set up the RS-232 connection to the control system as follows:

- a. In the Quantum Control Software window, click **Communications Setup** on the left Taskbar panel.
- b. On the Communications Setup screen, select **COM1** in the Devices panel (see figure 66, ①).
- c. In the Port Settings panel (②), enter the settings required by the control system being used.
- d. In the Serial Commands panel (③), select the **Input** and **Output** checkboxes to enable commands to be received from the control system via RS-232.

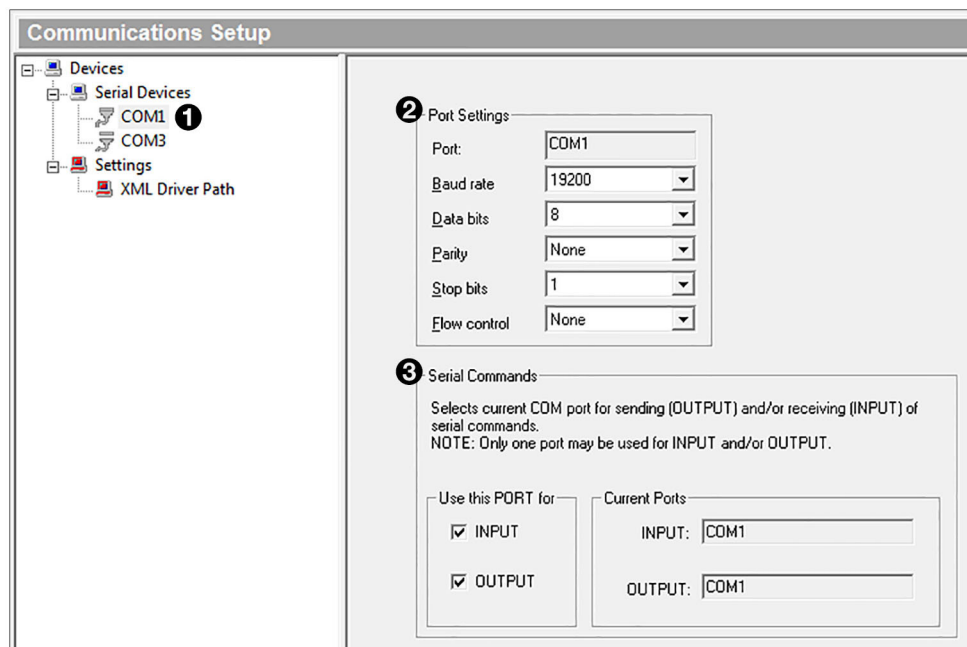

Figure 67. Configuring RS-232 Communication

4. Re-save the project file to the D: drive.
5. In the QC 101 Shell window, click **Commit C Drive** to reboot the QC 101, then confirm that the project file has been loaded and connected to the Quantum processors.

Front Panel Indicators

After the QC 101 has been connected and configured, no user operation is necessary. The front panel contains four green LEDs that provide status on QC 101 activity.



- | | |
|--------------------|----------------------------------|
| A Pwr LED | C LAN 2 LED |
| B LAN 1 LED | D Disk drive activity LED |

Figure 68. QC 101 Front Panel

- A Power (Pwr) LED** — Indicates power status to the unit:
- **Unlit** — Power is off.
 - **Blinking** — The system configuration files are booting (the unit is not operational).
 - **Lit steadily** — Power is on and the unit is operational.
- B LAN 1 LED and C LAN 2 LED** — Indicate the activity of the two Ethernet ports:
- **Unlit** — No data or network connection is detected.
 - **Blinking** — A network link has been established and data is being transmitted or received by the port.
 - **Lit steadily** — A network link has been established, but no network activity is present.
- D Disk Drive LED** — Indicates the activity of the internal disk drive:
- **Unlit** — There is no disk drive activity.
 - **Blinking** — There is activity on the disk drive.

NOTE: The USB Config port on this panel is not used on this product.

Reference Information

This section contains reference information about the Quantum products. Topics that are covered include:

- [Mounting](#)
- [Network Setup](#)

Mounting

UL Guidelines for Rack Mounting

The following Underwriters Laboratories (UL) guidelines pertain to the installation of the Quantum processor into a rack:

- **Elevated operating ambient temperature** — If the equipment is installed in a closed or multi-unit rack assembly, the operating ambient temperature of the rack environment may be greater than room ambient. Therefore, consider installing the equipment in an environment compatible with the maximum ambient temperature (TMA) of 95 °F (35 °C).
- **Reduced air flow** — Install the equipment in the rack so that the amount of air flow required for safe operation of the equipment is not compromised.
- **Mechanical loading** — Mount the equipment in the rack so that uneven mechanical loading does not create a hazardous condition.
- **Circuit overloading** — When connecting the equipment to the supply circuit, consider the connection of the equipment to the supply circuit and the effect that circuit overloading might have on overcurrent protection and supply wiring. Consider equipment nameplate ratings when addressing this concern.
- **Reliable earthing (grounding)** — Maintain reliable grounding of rack-mounted equipment. Pay particular attention to supply connections other than direct connections to the branch circuit (such as the use of power strips).

Rack Mounting the Quantum Processor

The Quantum processor can be placed on a tabletop or mounted in a rack (recommended).

CAUTION: The Quantum processor is very heavy. When it is fully populated with input and output cards, its weight can be:

- **Quantum Elite 615:** Up to 61 lbs (27.5 kg)
- **Quantum Elite 408 and Quantum Connect:** Up to 38.6 lbs (17.5 kg).

It is strongly recommended that you seek assistance with lifting or moving the unit.

ATTENTION : Le processeur Quantum est très lourd. Lorsqu'il est entièrement équipé de cartes d'entrée et de sortie, son poids peut être :

- **Quantum Elite 615 :** jusque 27,5 kg (61 lbs)
- **Quantum Elite 408 et Quantum Connect :** jusque 17,5 kg (38.6 lbs).

Il est fortement recommandé que vous soyez assisté lorsque vous soulevez ou que vous déplacez l'unité.

Rack Mounting Requirements for Quantum

In addition to the UL guidelines (see [UL Guidelines for Rack Mounting](#) on the previous page), observe the following when mounting the processor:

Support

Always use additional support at the sides or rear of the Quantum unit, attached to both the front and rear rack posts. Ensure that the shelf or other mounting accessories can support the full weight of the unit.

ATTENTION:

- **Do not** rely on the processor mounting flanges to support the full weight of the unit. These must be used only to secure the unit within the rack.
- Ne comptez pas sur les oreilles de rackage du processeur pour soutenir tout le poids de l'appareil. Celles-ci doivent seulement être utilisées pour bloquer l'unité à l'intérieur du rack.
- **Do not** stand other units directly on top of the processor when it is rack mounted because this can overload the mountings.
- N'installez pas d'autres produits directement au-dessus du processeur lorsque celui-ci est monté en rack : cela risquerait de surcharger les éléments de montage.

Ventilation

Ensure that sufficient airflow is provided to satisfy the ventilation requirements of **all** items of equipment installed in the rack.

A ventilation gap of at least 4 inches (10 cm) must be left between the front and rear panels of the Quantum and adjacent surfaces or equipment.

Rack mounting procedure for Quantum

The Quantum processors are housed in rack-mountable metal enclosures with mounting flanges for standard 19-inch racks.

Mount the processor as follows (see figure 69):

1. Insert the unit into the rack, aligning the holes in the mounting flanges with those in the rack.
2. Secure the processor to the rack using the supplied bolts.

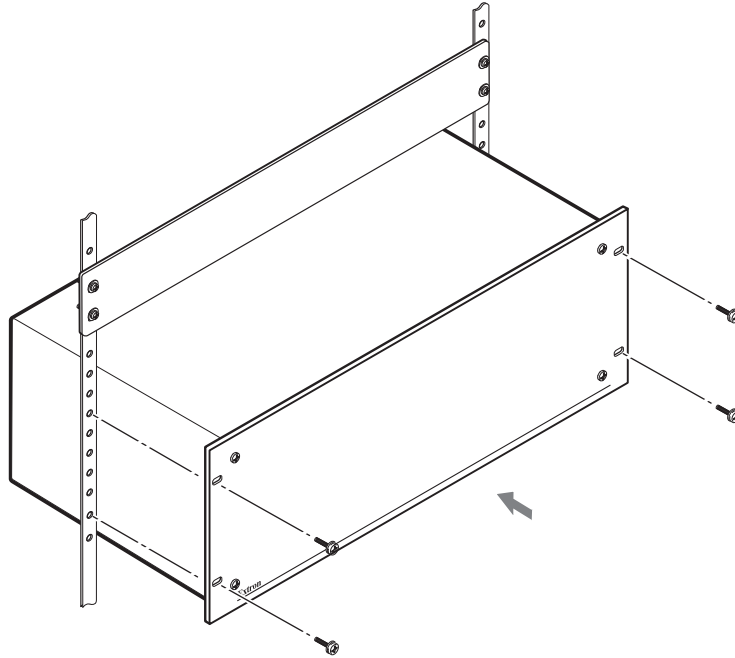

Figure 69. Rack Mounting the Quantum Processor

ATTENTION:

- Because of the weight of the Quantum processor, you may need to provide additional support for the unit from the back.
- Du fait du poids du processeur Quantum, il peut être nécessaire d'ajouter un support supplémentaire à l'arrière de l'unité.

Mounting the QC 101

The QC 101 can be placed on a table, desk, or podium (attach the provided rubber feet) or mounted on a standard 19-inches wide rack shelf. To rack mount the unit, see the instructions provided with the mounting kit.

Network Setup

What is an IP Address?

An IP address is a 32-bit binary number that is used to identify each device on an Ethernet network. This number is usually four decimal numbers (called “octets”), each in the range of 0 to 255 and separated by dots, such as 198.123.34.240. This is called “dotted decimal notation.”

An IP address is divided into two parts: a **network identifier** and a **host identifier**.

Each address on a given network must have the same network identifier value but a unique host identifier. As a result, there are different classes that define the range of valid addresses and which parts of the address are used for the network and host identifiers. The most common IP address classes are:

Class Name	Valid Address Range	Identifier Arrangement
Class A	0.0.0.1 to 127.255.255.254	<i>NNN . HHH . HHH . HHH</i>
Class B	128.0.0.1 to 191.255.255.254	<i>NNN . NNN . HHH . HHH</i>
Class C	192.0.0.1 to 223.255.255.254	<i>NNN . NNN . NNN . HHH</i>

NNN refers to the network identifier and *HHH* refers to the host identifier.

Choosing IP Addresses

If the computer and Quantum processor are directly connected or connected via their own independent network, follow the guidelines below for choosing the IP addresses.

However, if you intend to connect your computer and Quantum processors to an existing network, notify the network administrator and ask him or her to allocate suitable IP addresses.

On an independent network, it is generally recommended that you use the Class C format (from 192.0.0.1 to 223.255.255.254).

There are two rules for choosing IP addresses:

- The network identifier must be the same for each IP address.
- The host identifier must be unique for each address.

Applying these rules to Class C addresses, the first three decimal values of your IP address must all be the same, while the last value is used to uniquely identify each device.

The following is an example of a **valid** Class C addressing scheme:

Device	IP Address
Computer running Quantum Control Software	192.168.180.41
Quantum processor 1	192.168.180.42
Quantum processor 2	192.168.180.43

NOTE: The host identifiers (41, 42, and 43 in the above example) do not need to be sequential or in any particular order. However, it is recommended that you group the numbers for simplicity.

The following is an example of an **invalid** Class C addressing scheme:

Device	IP Address
Computer running Quantum Control Software	192.168.180.41
Quantum processor 1	168.192.180.42
Quantum processor 2	209.100.180.43

NOTE: The above addresses are invalid because the network identifier for each address is not the same even though each IP address is unique.

You can perform a test from your computer to check that a device at a particular address is responding correctly or to determine its address (see [Pinging for the IP Address](#)).

Subnet Mask

The subnet mask is another 32-bit binary number that is used to “mask” certain bits of the IP address. This provides a method of extending the number of network options for a given IP address. It works by allowing part of the host identifier to be used as a subnet identifier.

It is important that you set the correct value for the subnet mask. The basic values depend on the class of IP address being used.

Class Name	Subnet Mask
Class A	255.0.0.0
Class B	255.255.0.0
Class C	255.255.255.0

See [Subnetting, a Primer](#) on the next page for more information.

Pinging for the IP Address

To access the Quantum via the Ethernet port, you need the processor IP address. If the address has been changed to an address comprised of words and characters, the actual numeric IP address can be determined using the Ping utility. If the address has not been changed, the factory-specified default is 192.168.254.254.

Pinging to determine the Extron IP address

The Microsoft Ping utility is available at the command prompt. Ping tests the Ethernet interface between the computer and the processor. It can also be used to determine the actual numeric IP address from an alias and determine the web address. To ping the processor:

- 1. Windows XP:** From the Windows **Start** menu, select **Run...**
Windows 7: Click the **Start** button on the Windows taskbar, then enter **Run** in the search field.
Windows 8: On the **Start** screen, enter **Run** in the search field.
- 2.** In the **Open** text field, enter **command**.
- 3.** Click **OK**. A command window opens.

4. At the command prompt, enter `ping IP address`. The computer returns a display similar to the one shown in figure 70.

The `Pinging ...` line reports the actual numeric IP address, regardless of whether you entered the address or an alias name.

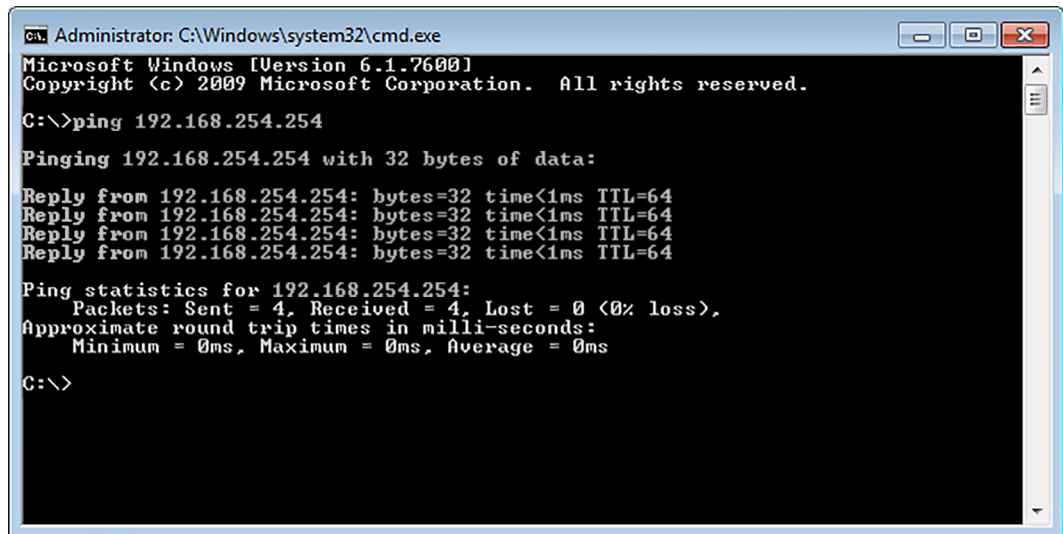

```
Administrator: C:\Windows\system32\cmd.exe
Microsoft Windows [Version 6.1.7600]
Copyright (c) 2009 Microsoft Corporation. All rights reserved.

C:\>ping 192.168.254.254

Pinging 192.168.254.254 with 32 bytes of data:

Reply from 192.168.254.254: bytes=32 time<1ms TTL=64
Reply from 192.168.254.254: bytes=32 time<1ms TTL=64
Reply from 192.168.254.254: bytes=32 time<1ms TTL=64
Reply from 192.168.254.254: bytes=32 time<1ms TTL=64

Ping statistics for 192.168.254.254:
    Packets: Sent = 4, Received = 4, Lost = 0 (0% loss),
    Approximate round trip times in milli-seconds:
        Minimum = 0ms, Maximum = 0ms, Average = 0ms

C:\>
```

Figure 70. Ping Response

Pinging to determine the Web IP address

The Ping utility has a modifier, `-a`, that directs the command to return the Web address rather than the numeric IP address.

At the prompt, enter `ping -a IP address`. The display that the computer returns is similar to the Ping response shown in figure 70, except that when you specify the `-a` modifier, the line `Pinging mail...` reports the web IP address instead of the numeric IP address, regardless of whether you entered the actual numeric IP address or an alias name.

Subnetting, a Primer

A subnet is a **subset** of a **network** — a set of IP devices that have portions of their IP addresses in common. It is not the purpose of this guide to describe TCP/IP protocol in detail. However, some understanding of TCP/IP subnetting is necessary in order to understand the interaction of the Quantum and the mail server gateway. To understand subnetting at the level required to install and operate the Quantum, you must understand the concepts of a gateway, local and remote devices, IP addresses and octets, and subnet masks and octets.

Gateways

The Quantum can communicate with the e-mail server that it uses for e-mail notification directly (if they are on the same subnet), or the communication can be routed via a gateway (a computer that provides a link between different subnets).

Local and remote devices

The local and remote devices are defined from the point of view of the function being described. In this guide, subnetting is an issue when you are using the controlling computer to set TCP/IP and e-mail values for the processor. When you are setting up the variables for e-mail notification, the Quantum processor is the local device and the e-mail server is the remote device.

IP addresses and octets

Valid IP addresses consist of four 1-, 2-, or 3-digit numeric sub-fields, called “octets,” which are separated by dots (periods) (figure 71). Each octet can be numbered from 000 through 255. Leading zeros, up to 3 digits total per octet, are optional. Values of 256 and above are invalid.

Typical IP Address: 192.168.254.254
Octets

Figure 71. IP Address and Octets

Subnet masks and octets

The subnet mask (see figure 72) is used to determine whether the local and remote devices are on the same subnet or different subnets. The subnet mask consists of four numeric octets separated by dots. Each octet can be numbered 000 through 255. Leading zeros, up to 3 digits total per octet, are optional. Each octet typically is either 255 or 0. The octets determine whether or not the same octets of two IP addresses will be compared when determining if two devices are on the same subnet.

255 indicates that this octet will be compared between two IP addresses.	0 indicates that this octet will not be compared between two IP addresses.
Typical Subnet Mask: <u>255.255.0.0</u>	
Octets	

Figure 72. Subnet Mask and Octets

Determining whether devices are on the same subnet

To determine the subnet, the local device IP address is compared to the remote device IP address (see figure 73). The octets of each address are compared or not, depending on the value in the related subnet mask octet.

- If a subnet mask octet has the value 255, the related octets of the local device address and the remote device IP address are unmasked.

Unmasked octets are compared (indicated by ? in figure 73).

- If the subnet mask octet has the value 0, the related octets of the local device and remote device IP addresses are masked.

Masked octets are not compared (indicated by X in figure 73).

If the unmasked octets of the two IP addresses **match** (indicated by = in example 1 of figure 73), the two addresses **are on the same subnet**.

If the two unmasked fields **do not match** (indicated by an unequal sign in figure 73, examples 2 and 3), the addresses **are not on the same subnet**.

	Example 1	Example 2	Example 3
Local IP Address:	192.168.254.254	192.168.254.254	192.168.254.254
Subnet Mask:	255.255.0.0 (??.X.X)	255.255.0.0 (??.X.X)	255.255.0.0 (??.X.X)
Remote IP Address:	192.168.2.25	190.190.2.25	192.190.2.25
Match?:	= . = .X.X – Match (Same subnet)	≠ . ≠ .X.X – No match (Different subnet)	= . ≠ .X.X – No match (Different subnet)

Figure 73. Comparing the IP Addresses

Extron Warranty

Extron Electronics warrants this product against defects in materials and workmanship for a period of three years from the date of purchase. In the event of malfunction during the warranty period attributable directly to faulty workmanship and/or materials, Extron Electronics will, at its option, repair or replace said products or components, to whatever extent it shall deem necessary to restore said product to proper operating condition, provided that it is returned within the warranty period, with proof of purchase and description of malfunction to:

**USA, Canada, South America,
and Central America:**

Extron Electronics
1230 South Lewis Street
Anaheim, CA 92805
U.S.A.

Asia:

Extron Asia Pte Ltd
135 Joo Seng Road, #04-01
PM Industrial Bldg.
Singapore 368363
Singapore

Japan:

Extron Electronics, Japan
Kyodo Building, 16 Ichibancho
Chiyoda-ku, Tokyo 102-0082
Japan

Europe:

Extron Europe
Hanzeboulevard 10
3825 PH Amersfoort
The Netherlands

China:

Extron China
686 Ronghua Road
Songjiang District
Shanghai 201611
China

Middle East:

Extron Middle East
Dubai Airport Free Zone
F13, PO Box 293666
United Arab Emirates, Dubai

Africa:

Extron South Africa
3rd Floor, South Tower
160 Jan Smuts Avenue
Rosebank 2196, South Africa

This Limited Warranty does not apply if the fault has been caused by misuse, improper handling care, electrical or mechanical abuse, abnormal operating conditions, or if modifications were made to the product that were not authorized by Extron.

NOTE: If a product is defective, please call Extron and ask for an Application Engineer to receive an RA (Return Authorization) number. This will begin the repair process.

USA: 714.491.1500 or 800.633.9876

Asia: 65.6383.4400

Europe: 31.33.453.4040 or 800.3987.6673

Japan: 81.3.3511.7655

Africa: 27.11.447.6162

Middle East: 971.4.299.1800

Units must be returned insured, with shipping charges prepaid. If not insured, you assume the risk of loss or damage during shipment. Returned units must include the serial number and a description of the problem, as well as the name of the person to contact in case there are any questions.

Extron Electronics makes no further warranties either expressed or implied with respect to the product and its quality, performance, merchantability, or fitness for any particular use. In no event will Extron Electronics be liable for direct, indirect, or consequential damages resulting from any defect in this product even if Extron Electronics has been advised of such damage.

Please note that laws vary from state to state and country to country, and that some provisions of this warranty may not apply to you.