

## Audio Extractor

# 3G-AE 100

SDI Audio Extractor



**Extron Electronics**  
INTERFACING, SWITCHING AND CONTROL

# Safety Instructions

## Safety Instructions • English

**WARNING:** This symbol, ⚠, when used on the product, is intended to alert the user of the presence of uninsulated dangerous voltage within the product's enclosure that may present a risk of electric shock.

**ATTENTION:** This symbol, ⚠, when used on the product, is intended to alert the user of important operating and maintenance (servicing) instructions in the literature provided with the equipment.

For information on safety guidelines, regulatory compliances, EMI/EMF compatibility, accessibility, and related topics, see the Extron Safety and Regulatory Compliance Guide, part number 68-290-01, on the Extron website, [www.extron.com](http://www.extron.com).

## Instructions de sécurité • Français

**AVERTISSEMENT:** Ce pictogramme, ⚠, lorsqu'il est utilisé sur le produit, signale à l'utilisateur la présence à l'intérieur du boîtier du produit d'une tension électrique dangereuse susceptible de provoquer un choc électrique.

**ATTENTION:** Ce pictogramme, ⚠, lorsqu'il est utilisé sur le produit, signale à l'utilisateur des instructions d'utilisation ou de maintenance importantes qui se trouvent dans la documentation fournie avec le matériel.

Pour en savoir plus sur les règles de sécurité, la conformité à la réglementation, la compatibilité EMI/EMF, l'accessibilité, et autres sujets connexes, lisez les informations de sécurité et de conformité Extron, réf. 68-290-01, sur le site Extron, [www.extron.fr](http://www.extron.fr).

## Sicherheitsanweisungen • Deutsch

**WARNUNG:** Dieses Symbol ⚠ auf dem Produkt soll den Benutzer darauf aufmerksam machen, dass im Inneren des Gehäuses dieses Produktes gefährliche Spannungen herrschen, die nicht isoliert sind und die einen elektrischen Schlag verursachen können.

**VORSICHT:** Dieses Symbol ⚠ auf dem Produkt soll dem Benutzer in der im Lieferumfang enthaltenen Dokumentation besonders wichtige Hinweise zur Bedienung und Wartung (Instandhaltung) geben.

Weitere Informationen über die Sicherheitsrichtlinien, Produkthandhabung, EMI/EMF-Kompatibilität, Zugänglichkeit und verwandte Themen finden Sie in den Extron-Richtlinien für Sicherheit und Handhabung (Artikelnummer 68-290-01) auf der Extron-Website, [www.extron.de](http://www.extron.de).

## Instrucciones de seguridad • Español

**ADVERTENCIA:** Este símbolo, ⚠, cuando se utiliza en el producto, avisa al usuario de la presencia de voltaje peligroso sin aislar dentro del producto, lo que puede representar un riesgo de descarga eléctrica.

**ATENCIÓN:** Este símbolo, ⚠, cuando se utiliza en el producto, avisa al usuario de la presencia de importantes instrucciones de uso y mantenimiento recogidas en la documentación proporcionada con el equipo.

Para obtener información sobre directrices de seguridad, cumplimiento de normativas, compatibilidad electromagnética, accesibilidad y temas relacionados, consulte la Guía de cumplimiento de normativas y seguridad de Extron, referencia 68-290-01, en el sitio Web de Extron, [www.extron.es](http://www.extron.es).

## Chinese Simplified (简体中文)

**警告:** ⚠ 产品上的这个标志意在警告用户该产品机壳内有暴露的危险电压, 有触电危险。

**注意:** ⚠ 产品上的这个标志意在提示用户设备随附的用户手册中有重要的操作和维护(维修)说明。

关于我们产品的安全指南、遵循的规范、EMI/EMF 的兼容性、无障碍使用的特性等相关内容, 敬请访问 Extron 网站 [www.extron.cn](http://www.extron.cn), 参见 Extron 安全规范指南, 产品编号 68-290-01。

## Chinese Traditional (繁體中文)

**警告:** ⚠ 若產品上使用此符號, 是為了提醒使用者, 產品機殼內存在著可能會導致觸電之風險的未絕緣危險電壓。

**注意:** ⚠ 若產品上使用此符號, 是為了提醒使用者。

有關安全性指導方針、法規遵守、EMI/EMF 相容性、存取範圍和相關主題的詳細資訊, 請瀏覽 Extron 網站: [www.extron.cn](http://www.extron.cn), 然後參閱《Extron 安全性與法規遵守手冊》, 準則編號 68-290-01。

## Japanese

**警告:** この記号 ⚠ が製品上に表示されている場合は、筐体内に絶緣されていない高電圧が流れ、感電の危険があることを示しています。

**注意:** この記号 ⚠ が製品上に表示されている場合は、本機の取扱説明書に記載されている重要な操作と保守(整備)の指示についてユーザーの注意を喚起するものです。

安全上のご注意、法規遵守、EMI/EMF適合性、その他の関連項目については、エクストロンのウェブサイト[www.extron.jp](http://www.extron.jp)より『Extron Safety and Regulatory Compliance Guide』(P/N 68-290-01)をご覧ください。

## Korean

**경고:** 이 기호 ⚠ 가 제품에 사용될 경우, 제품의 인클로저 내에 있는 접지되지 않은 위험한 전류로 인해 사용자가 감전될 위험이 있음을 경고합니다.

**주의:** 이 기호 ⚠ 가 제품에 사용될 경우, 장비와 함께 제공된 책자에 나와 있는 주요 운영 및 유지보수(정비) 지침을 경고합니다.

안전 가이드라인, 규제 준수, EMI/EMF 호환성, 접근성, 그리고 관련 항목에 대한 자세한 내용은 Extron 웹 사이트([www.extron.co.kr](http://www.extron.co.kr))의 Extron 안전 및 규제 준수 안내서, 68-290-01 조항을 참조하십시오.

## FCC Class A Notice

This equipment has been tested and found to comply with the limits for a Class A digital device, pursuant to part 15 of the FCC rules. The Class A limits provide reasonable protection against harmful interference when the equipment is operated in a commercial environment. This equipment generates, uses, and can radiate radio frequency energy and, if not installed and used in accordance with the instruction manual, may cause harmful interference to radio communications. Operation of this equipment in a residential area is likely to cause interference; the user must correct the interference at his own expense.

**NOTE:** This unit was tested with shielded I/O cables on the peripheral devices. Shielded cables must be used to ensure compliance with FCC emissions limits.

For more information on safety guidelines, regulatory compliances, EMI/EMF compatibility, accessibility, and related topics, see the “[Extron Safety and Regulatory Compliance Guide](#)” on the Extron website.

## Copyright

© 2013 Extron Electronics. All rights reserved.

## Trademarks

All trademarks mentioned in this guide are the properties of their respective owners.

**The following registered trademarks®, registered service marks<sup>(SM)</sup>, and trademarks<sup>(TM)</sup> are the property of RGB Systems, Inc. or Extron Electronics:**

| Registered Trademarks <sup>(®)</sup>  |
|---|
| AVTrac, Cable Cubby, CrossPoint, eBUS, EDID Manager, EDID Minder, Extron, Flat Field, GlobalViewer, Hideaway, Inline, IP Intercom, IP Link, Key Minder, LockIt, MediaLink, PoleVault, PowerCage, PURE3, Quantum, SoundField, SpeedMount, SpeedSwitch, System Integrator, TeamWork, TouchLink, V-Lock, VersaTools, VN-Matrix, VoiceLift, WallVault, WindoWall, XTP and XTP Systems   |
| <b>Registered Service Mark<sup>(SM)</sup> :</b> S3 Service Support Solutions  |
| Trademarks <sup>(TM)</sup>  |
| AAP, AFL (Accu-Rate Frame Lock), ADSP (Advanced Digital Sync Processing), AIS (Advanced Instruction Set), Auto-Image, CDRS (Class D Ripple Suppression), DDSP (Digital Display Sync Processing), DMI (Dynamic Motion Interpolation), Driver Configurator, DSP Configurator, DSVP (Digital Sync Validation Processing), FastBite, FOXBOX, IP Intercom HelpDesk, MAAP, MicroDigital, ProDSP, QS-FPC (QuickSwitch Front Panel Controller), Scope-Trigger, SIS, Simple Instruction Set, Skew-Free, SpeedNav, Triple-Action Switching, XTRA, ZipCaddy, ZipClip |

## Conventions Used in this Guide

### Notifications

The following notifications are used in this guide:

**ATTENTION:** Attention indicates a situation that may damage or destroy the product or associated equipment.

**NOTE:** A note draws attention to important information.

### Specifications Availability

Product specifications are available on the Extron website, [www.extron.com](http://www.extron.com).

# Contents

---

**Introduction..... 1**

- About the 3G-AE 100..... 1
- Features ..... 1

---

**Panels and Cabling ..... 2**

- Front Panel Features..... 2
- Rear Panel Features and Cabling..... 2

---

**Operation..... 5**

- Audio Group Selection..... 5

---

**Reference Information ..... 6**

- SDI Audio Channel Designation ..... 6
- Mounting..... 7
  - Tabletop Placement ..... 7
  - Rack Mounting ..... 7
  - Under-desk and Furniture Mounting..... 7

# Introduction

This section covers the following:

- [About the 3G-AE 100](#)
- [Features](#)

## About the 3G-AE 100

The Extron 3G-AE 100 extracts embedded audio from a 3G-SDI, HD-SDI, or SDI signal, converts digital audio to analog audio, and provides analog stereo audio to the output ports. Figure 1 shows a typical 3G-AE 100 application.

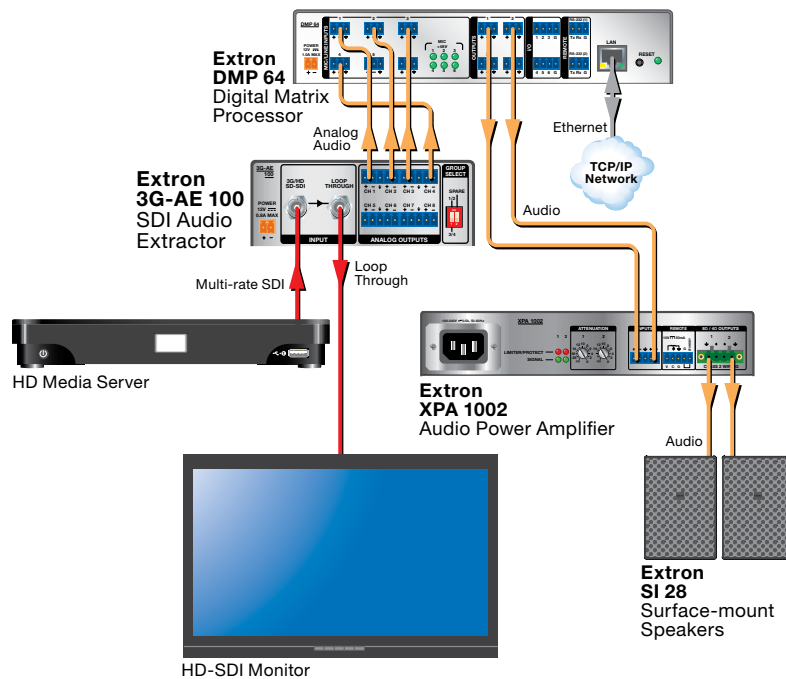

**Figure 1. 3G-AE 100 Application Diagram**

## Features

- Supports up to 2.97 Gbps of SDI and 3G-SDI data
- Compatible with Extron SDI products such as SW4 3G HD-SDI, 3G HD-SDI 101 and FOX 3G HD-SDI.
- One SDI input
- One SDI buffered loop through
- Eight analog audio outputs
- One DIP switch for audio group selection

# Panels and Cabling

This section covers the following:

- [Front Panel Features](#)
- [Rear Panel Features and Cabling](#)

## Front Panel Features

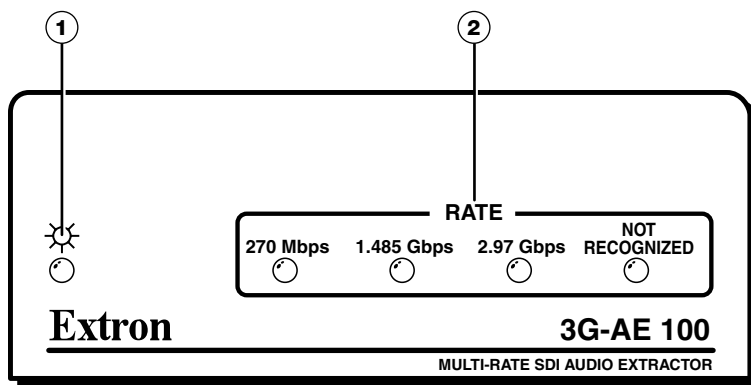

- ① **Power LED** — lights green when the unit is receiving power.
- ② **Rate LEDs** — indicate the data rate of the incoming SDI signal (270 Mbps, 1.485 Gbps, or 2.97 Gbps). If a signal is unrecognized, the “Not Recognized” LED will light.  
  
Rate LEDs will light once from left to right as a power up sequence when the unit is powered.

## Rear Panel Features and Cabling

The following section covers rear panel features and cabling procedures. If mounting is necessary before connecting cables, see the [Mounting](#) section on page 7.

**ATTENTION:** Turn the input and output devices off and unplug their power cords. Verify that the 3G-AE 100 is disconnected from the power source before proceeding.

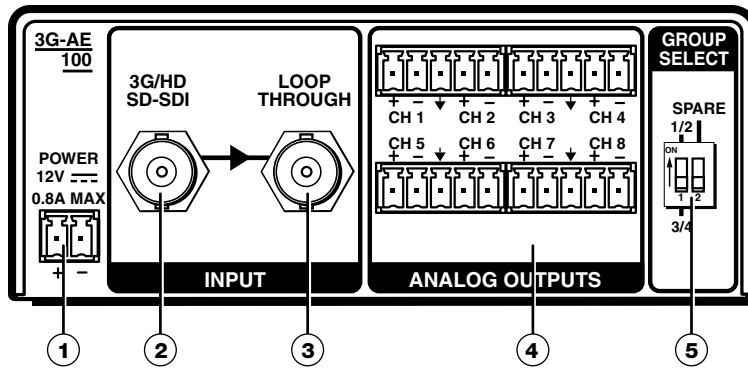

**Figure 2. 3G-AE 100 Rear Panel**

- ① **Power input** — Wire the power supply as shown in figure 3, and connect it to the power connector.

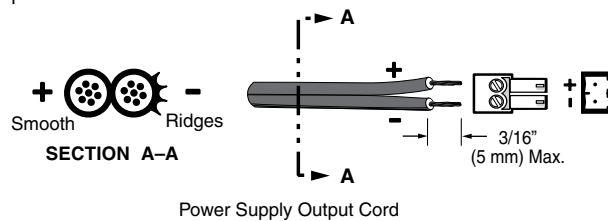

**Figure 3. Power Connection**

**ATTENTION:**

- Do not tin the wires. For best results and to reduce the risk of short circuits, trim just 3/16 inch (5 mm) of the jacket from the wires. If it is any longer, the exposed wires may touch, causing a short circuit between them. If it is any shorter, the wires can be easily pulled out even if tightly fastened by the captive screws.
- Always use a power supply supplied by or specified by Extron. Use of an unauthorized power supply voids all regulatory compliance certification and may cause damage to the supply and the end product.
- Unless otherwise stated, the AC/DC adapters are not suitable for use in air handling spaces or in wall cavities. The power supply is to be located within the same vicinity as the Extron AV processing equipment in an ordinary location, Pollution Degree 2, secured to the equipment rack within the dedicated closet, podium or desk.
- The installation must always be in accordance with the applicable provisions of National Electrical Code ANSI/NFPA 70, article 75 and the Canadian Electrical Code part 1, section 16. The power supply shall not be permanently fixed to building structure or similar structure.

**NOTE:** Do not tin the wires. Tinned wire does not hold its shape and can become loose over time.

- ② **3G-SDI Input** — Connect an input device to the 3G-SDI input connector. The incoming SDI signal is automatically detected and equalized.

Input equalization will allow signal transmission distances as follows:

- SDI: Up to 1400 feet (426 m) using RG6 cable
- HD-SDI: Up to 600 feet (182 m) using RG6 cable
- 3G-SDI: Up to 500 feet (152 m) using RG6 cable

- ③ **Loop Through connector** — If necessary, plug in an output device to the Loop Through connector. The SDI input signal is equalized, re-clocked, and routed to the Loop Through connector. This connector may also be used for cascading to another 3G-AE 100.

**NOTE:** It is not required to connect a device to the Loop Through connector in order to extract audio from the input device.

- ④ **Analog Outputs** — Connect up to four audio output devices to the Analog Outputs, using a cable with a balanced or unbalanced 3.5 mm, 5-pole captive screw connector. Wire as shown below.

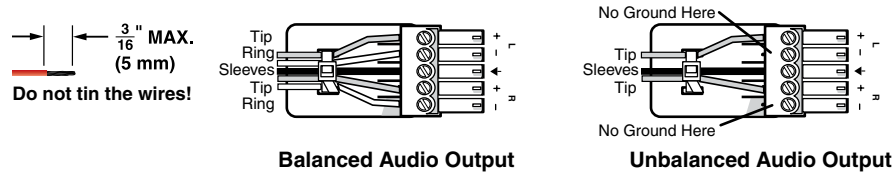

**Figure 4. Analog Output Connector Wiring**

**ATTENTION:** Connect the sleeve to the ground (Gnd) terminal. Connecting the sleeve to a negative (-) terminal will damage the audio output circuits.

- ⑤ **Group Select DIP switch** — see the **Operation** section on the next page for instructions on using the Group Select DIP switch.

# Operation

## Audio Group Selection

The 3G-AE 100 supports up to sixteen channels (eight stereo pairs) of embedded digital audio. SDI audio is divided into four groups; each group has four channels (two stereo pairs). When a group is enabled, its channels are extracted and routed to the 3G-AE 100 analog output ports.

The Group Select DIP switch can enable two groups at the same time:

- To enable groups 1 and 2, set the Group Select switch to 1/2.

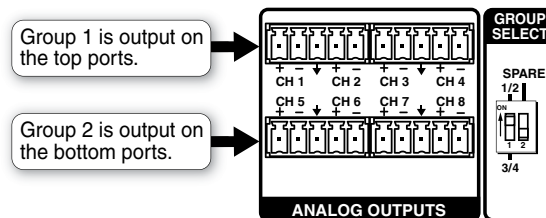

- To enable groups 3 and 4, set the Group Select switch to 3/4.

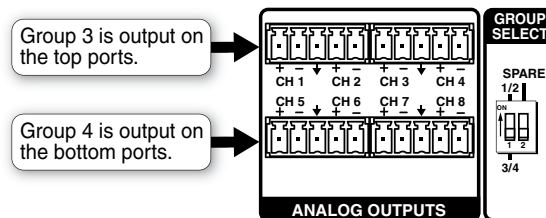

**NOTE:** All sixteen channels can be extracted at the same time by cascading two 3G-AE 100 devices via the Loop Through input (see ③ on the previous page).

# Reference Information

This section covers the following:

- [SDI Audio Channel Designation](#)
- [Mounting](#)

## SDI Audio Channel Designation

The following table shows the typical SDI audio channel designations for SDI audio groups 1/2 and 3/4.

- Audio groups 1/2 (AES channel pairs 1-4):

| Group | AES Pair number | AES Channel number | SDI Channel No. | Label/ Name       | Description   |
|-------|-----------------|--------------------|-----------------|-------------------|---|
| 1     | Pair 1          | 1                  | 1               | L/Left            | Far left screen loudspeaker                         |
|       |                 | 2                  | 2               | R/Right           | Far right screen loudspeaker                        |
|       | Pair 2          | 1                  | 3               | C/Center          | Center screen loudspeaker                           |
|       |                 | 2                  | 4               | LFE/ Screen       | Screen low frequency effects subwoofer loudspeakers |
| 2     | Pair 3          | 1                  | 5               | Ls/Left surround  | Left wall surround loudspeakers                     |
|       |                 | 2                  | 6               | Rs/Right surround | Right wall surround loudspeakers                    |
|       | Pair 4          | 1                  | 7               | Lc/Left center    | Mid left to center screen loudspeaker               |
|       |                 | 2                  | 8               | Rc/Right center   | Mid right to center screen loudspeaker              |

- Audio groups 3/4 (AES channel pairs 5-8):

| Group | AES Pair number | AES Channel number | SDI Channel No. | Label/ Name        | Description                     |
|-------|-----------------|--------------------|-----------------|--------------------|---------------------------------|
| 3     | Pair 5          | 1                  | 9               | Cs/Center surround | Rear wall surround loudspeakers |
|       |                 | 2                  | 10              |                    | SMPTE reserved                  |
|       | Pair 6          | 1                  | 11              |                    | SMPTE reserved                  |
|       |                 | 2                  | 12              |                    | SMPTE reserved                  |
| 4     | Pair 7          | 1                  | 13              |                    | SMPTE reserved                  |
|       |                 | 2                  | 14              |                    | SMPTE reserved                  |
|       | Pair 8          | 1                  | 15              |                    | User defined                    |
|       |                 | 2                  | 16              |                    | User defined                    |

# Mounting

## Tabletop Placement

Attach the four provided rubber feet to the bottom of the unit and place it in any convenient location.

## Rack Mounting

### UL Guidelines for Rack Mounting

The following Underwriters Laboratories (UL) guidelines are relevant to the safe installation of these products in a rack:

- **Elevated operating ambient temperature** — If the unit is installed in a closed or multi-unit rack assembly, the operating ambient temperature of the rack environment may be greater than room ambient temperature. Therefore, install the equipment in an environment compatible with the maximum ambient temperature (TMA = +122 °F, +50 °C) specified by Extron.
- **Reduced air flow** — Install the equipment in the rack so that safe operation and adequate air flow is provided to the unit.
- **Mechanical loading** — Mount the equipment in the rack so that a hazardous condition is not achieved due to uneven mechanical loading.
- **Circuit overloading** — Connect the equipment to the supply circuit and consider the effect that circuit overloading might have on overcurrent protection and supply wiring. Consider the equipment nameplate ratings when addressing this concern.
- **Reliable earthing (grounding)** — Maintain reliable grounding of rack-mounted equipment. Pay particular attention to supply connections other than direct connections.

### Rack Mounting Procedure

These units can be mounted on optional rack systems listed on the website (see [www.extron.com](http://www.extron.com)). To mount the unit on a rack shelf, follow the instructions provided with the shelf accessories.

### Back of the Rack Mounting Procedure

The 3G-AE 100 can be mounted to the rear of a rack using an optional back of rack mounting kit (see [www.extron.com](http://www.extron.com)). The kit allows the product to be vertically mounted to the front or rear rack supports and facing either towards the front or the rear of the rack. To mount the unit, follow the instructions provided with the kit.

## Under-desk and Furniture Mounting

Mount the unit under a desk or podium, using the optional Extron MBU 123 under-desk mounting kit. Follow the instructions provided with the kit.

# Extron Warranty

Extron Electronics warrants this product against defects in materials and workmanship for a period of three years from the date of purchase. In the event of malfunction during the warranty period attributable directly to faulty workmanship and/or materials, Extron Electronics will, at its option, repair or replace said products or components, to whatever extent it shall deem necessary to restore said product to proper operating condition, provided that it is returned within the warranty period, with proof of purchase and description of malfunction to:

**USA, Canada, South America,**

and Central America:  
Extron Electronics  
1230 South Lewis Street  
Anaheim, CA 92805  
U.S.A.

**Japan:**

Extron Electronics, Japan  
Kyodo Building, 16 Ichibancho  
Chiyoda-ku, Tokyo 102-0082  
Japan

**Europe and Africa:**

Extron Europe  
Hanzeboulevard 10  
3825 PH Amersfoort  
The Netherlands

**China:**

Extron China  
686 Ronghua Road  
Songjiang District  
Shanghai 201611  
China

**Asia:**

Extron Asia Pte Ltd  
135 Joo Seng Road, #04-01  
PM Industrial Bldg.  
Singapore 368363  
Singapore

**Middle East:**

Extron Middle East  
Dubai Airport Free Zone  
F12, PO Box 293666  
United Arab Emirates, Dubai

This Limited Warranty does not apply if the fault has been caused by misuse, improper handling care, electrical or mechanical abuse, abnormal operating conditions, or if modifications were made to the product that were not authorized by Extron.

**NOTE:** If a product is defective, please call Extron and ask for an Application Engineer to receive an RA (Return Authorization) number. This will begin the repair process.

**USA:** 714.491.1500 or 800.633.9876

**Europe:** 31.33.453.4040

**Asia:** 65.6383.4400

**Japan:** 81.3.3511.7655

Units must be returned insured, with shipping charges prepaid. If not insured, you assume the risk of loss or damage during shipment. Returned units must include the serial number and a description of the problem, as well as the name of the person to contact in case there are any questions.

Extron Electronics makes no further warranties either expressed or implied with respect to the product and its quality, performance, merchantability, or fitness for any particular use. In no event will Extron Electronics be liable for direct, indirect, or consequential damages resulting from any defect in this product even if Extron Electronics has been advised of such damage.

Please note that laws vary from state to state and country to country, and that some provisions of this warranty may not apply to you.

|   |   |  |  |   |   |   |   |  |
|---|---|--|--|---|---|---|---|--|
| <b>Extron Headquarters</b><br>+1.800.633.9876 (Inside USA/Canada Only)<br>Extron USA - West<br>+1.714.491.1500<br>+1.714.491.1517 FAX | <b>Extron USA - East</b><br>Extron USA - East<br>+1.919.850.1000<br>+1.919.850.1001 FAX | <b>Extron Europe</b><br>+800.3987.6673<br>(Inside Europe Only)<br>+31.33.453.4040<br>+31.33.453.4050 FAX | <b>Extron Asia</b><br>+65.6383.4400<br>+65.6383.4664 FAX | <b>Extron Japan</b><br>+81.3.3511.7655<br>+81.3.3511.7656 FAX | <b>Extron China</b><br>+86.21.3760.1568<br>+86.21.3760.1566 FAX | <b>Extron Middle East</b><br>+971.4.299.1800<br>+971.4.299.1880 FAX | <b>Extron Korea</b><br>+82.2.3444.1571<br>+82.2.3444.1575 FAX | <b>Extron India</b><br>1800.3070.3777<br>(Inside India Only)<br>+91.80.3055.3777<br>+91.80.3055.3737 FAX |
|---|---|--|--|---|---|---|---|--|