

IN1604 DTP IN1604 HD

Scaling Presentation Switchers



Extron Electronics
INTERFACING, SWITCHING AND CONTROL

Safety Instructions

Safety Instructions • English

WARNING: This symbol, ⚠, when used on the product, is intended to alert the user of the presence of uninsulated dangerous voltage within the product's enclosure that may present a risk of electric shock.

ATTENTION: This symbol, ⚠, when used on the product, is intended to alert the user of important operating and maintenance (servicing) instructions in the literature provided with the equipment.

For information on safety guidelines, regulatory compliances, EMI/EMF compatibility, accessibility, and related topics, see the Extron Safety and Regulatory Compliance Guide, part number 68-290-01, on the Extron website, www.extron.com.

Instructions de sécurité • Français

AVERTISSEMENT : Ce pictogramme, ⚠, lorsqu'il est utilisé sur le produit, signale à l'utilisateur la présence à l'intérieur du boîtier du produit d'une tension électrique dangereuse susceptible de provoquer un choc électrique.

ATTENTION : Ce pictogramme, ⚠, lorsqu'il est utilisé sur le produit, signale à l'utilisateur des instructions d'utilisation ou de maintenance importantes qui se trouvent dans la documentation fournie avec le matériel.

Pour en savoir plus sur les règles de sécurité, la conformité à la réglementation, la compatibilité EMI/EMF, l'accessibilité, et autres sujets connexes, lisez les informations de sécurité et de conformité Extron, réf. 68-290-01, sur le site Extron, www.extron.com.

Sicherheitsanweisungen • Deutsch

WARNUNG: Dieses Symbol ⚠ auf dem Produkt soll den Benutzer darauf aufmerksam machen, dass im Inneren des Gehäuses dieses Produktes gefährliche Spannungen herrschen, die nicht isoliert sind und die einen elektrischen Schlag verursachen können.

VORSICHT: Dieses Symbol ⚠ auf dem Produkt soll dem Benutzer in der im Lieferumfang enthaltenen Dokumentation besonders wichtige Hinweise zur Bedienung und Wartung (Instandhaltung) geben.

Weitere Informationen über die Sicherheitsrichtlinien, Produkthandhabung, EMI/EMF-Kompatibilität, Zugänglichkeit und verwandte Themen finden Sie in den Extron-Richtlinien für Sicherheit und Handhabung (Artikelnummer 68-290-01) auf der Extron-Website, www.extron.com.

Instrucciones de seguridad • Español

ADVERTENCIA: Este símbolo, ⚠, cuando se utiliza en el producto, avisa al usuario de la presencia de voltaje peligroso sin aislar dentro del producto, lo que puede representar un riesgo de descarga eléctrica.

ATENCIÓN: Este símbolo, ⚠, cuando se utiliza en el producto, avisa al usuario de la presencia de importantes instrucciones de uso y mantenimiento recogidas en la documentación proporcionada con el equipo.

Para obtener información sobre directrices de seguridad, cumplimiento de normativas, compatibilidad electromagnética, accesibilidad y temas relacionados, consulte la Guía de cumplimiento de normativas y seguridad de Extron, referencia 68-290-01, en el sitio Web de Extron, www.extron.com.

Инструкция по технике безопасности • Русский

ПРЕДУПРЕЖДЕНИЕ: Данный символ, ⚠, если указан на продукте, предупреждает пользователя о наличии неизолированного опасного напряжения внутри корпуса продукта, которое может привести к поражению электрическим током.

ВНИМАНИЕ: Данный символ, ⚠, если указан на продукте, предупреждает пользователя о наличии важных инструкций по эксплуатации и обслуживанию в руководстве, прилагаемом к данному оборудованию.

Для получения информации о правилах техники безопасности, соблюдении нормативных требований, электромагнитной совместимости (ЭМП/ЭДС), возможности доступа и других вопросах см. руководство по безопасности и соблюдению нормативных требований Extron на сайте Extron: www.extron.com, номер по каталогу - 68-290-01.

安全说明 • 简体中文

警告: ⚠ 产品上的这个标志意在警告用户该产品机壳内有暴露的危险电压, 有触电危险。

注意: ⚠ 产品上的这个标志意在提示用户设备随附的用户手册中有重要的操作和维护(维修)说明。

关于我们产品的安全指南、遵循的规范、EMI/EMF 的兼容性、无障碍使用的特性等相关内容, 敬请访问 Extron 网站 www.extron.com, 参见 Extron 安全规范指南, 产品编号 68-290-01。

安全記事 • 繁體中文

警告: ⚠ 若產品上使用此符號, 是為了提醒使用者, 產品機殼內存在著可能會導致觸電之風險的未絕緣危險電壓。

注意: ⚠ 若產品上使用此符號, 是為了提醒使用者, 設備隨附的用戶手冊中有重要的操作和維護(維修)說明。

有關安全性指導方針、法規遵守、EMI/EMF 相容性、存取範圍和相關主題的詳細資訊, 請瀏覽 Extron 網站: www.extron.com, 然後參閱《Extron 安全性與法規遵守手冊》, 準則編號 68-290-01。

安全上のご注意 • 日本語

警告: この記号 ⚠ が製品上に表示されている場合は、筐体内に絶縁されていない高電圧が流れ、感電の危険があることを示しています。

注意: この記号 ⚠ が製品上に表示されている場合は、本機の取扱説明書に記載されている重要な操作と保守(整備)の指示についてユーザーの注意を喚起するものです。

安全上のご注意、法規遵守、EMI/EMF適合性、その他の関連項目については、エクストロンのウェブサイト www.extron.com より『Extron Safety and Regulatory Compliance Guide』(P/N 68-290-01) をご覧ください。

안전 지침 • 한국어

경고: 이 기호 ⚠ 가 제품에 사용될 경우, 제품의 인클로저 내에 있는 접지되지 않은 위험한 전류로 인해 사용자가 감전될 위험이 있음을 경고합니다.

주의: 이 기호 ⚠ 가 제품에 사용될 경우, 장비와 함께 제공된 책자에 나와 있는 주요 운영 및 유지보수(정비) 지침을 경고합니다.

안전 가이드라인, 규제 준수, EMI/EMF 호환성, 접근성, 그리고 관련 항목에 대한 자세한 내용은 Extron 웹 사이트(www.extron.com)의 Extron 안전 및 규제 준수 안내서, 68-290-01 조항을 참조하십시오.

FCC Class A Notice

This equipment has been tested and found to comply with the limits for a Class A digital device, pursuant to part 15 of the FCC rules. The Class A limits provide reasonable protection against harmful interference when the equipment is operated in a commercial environment. This equipment generates, uses, and can radiate radio frequency energy and, if not installed and used in accordance with the instruction manual, may cause harmful interference to radio communications. Operation of this equipment in a residential area is likely to cause interference. This interference must be corrected at the expense of the user.

ATTENTION:

- The Twisted Pair Extension technology works with shielded twisted pair (STP) cables **only**. To ensure FCC Class A and CE compliance, STP cables and STP connectors are also required.
- For more information on safety guidelines, regulatory compliances, EMI/EMF compatibility, accessibility, and related topics, see the “[Extron Safety and Regulatory Compliance Guide](#)” on the Extron website.

Copyright

© 2015 Extron Electronics. All rights reserved.

Trademarks

All trademarks mentioned in this guide are the properties of their respective owners.

The following registered trademarks[®], registered service marksSM, and trademarksTM are the property of RGB Systems, Inc. or Extron Electronics:

Registered Trademarks [®]
AVTrac, Cable Cubby, CrossPoint, eBUS, EDID Manager, EDID Minder, Extron, Flat Field, Global Configurator, GlobalViewer, Hideaway, Inline, IP Intercom, IP Link, Key Minder, LockIt, MediaLink, PlenumVault, PoleVault, PowerCage, Pure3, Quantum, SoundField, SpeedMount, SpeedSwitch, System <i>INTEGRATOR</i> , TeamWork, TouchLink, V-Lock, VersaTools, VN-Matrix, VoiceLift, WallVault, WindoWall, XTP, and XTP Systems
Registered Service MarkSM : S3 Service Support Solutions
Trademarks TM
AAP, AFL (Accu-Rate Frame Lock), ADSP (Advanced Digital Sync Processing), Auto-Image, CableCover, CDRS (Class D Ripple Suppression), DDSP (Digital Display Sync Processing), DMI (Dynamic Motion Interpolation), Driver Configurator, DSP Configurator, DSVP (Digital Sync Validation Processing), DTP, eLink, EQIP, FastBite, FlexOS, FOX, FOXBOX, Global Configurator, IP Intercom HelpDesk, LinkLicense, MAAp, MicroDigital, NetPa, ProDSP, QS-FPC (QuickSwitch Front Panel Controller), Room Agent, Scope-Trigger, ShareLink, SIS, Simple Instruction Set, Skew-Free, SpeedNav, Triple-Action Switching, WebShare, XTRA, ZipCaddy, ZipClip

Conventions Used in this Guide

Notifications

The following notifications are used in this guide:

ATTENTION:

- Risk of property damage.
- Risque de dommages matériels.

NOTE: A note draws attention to important information.**TIP:** A tip provides a suggestion to make working with the application easier.

Software Commands

Commands are written in the fonts shown here:

```
^ARMerge Scene , ,Op1 scene 1,1 ^B 51 ^W^C  
[ 01 ] R 0004 00300 00400 00800 00600 [ 02 ] 35 [ 17 ] [ 03 ]
```

```
Esc [X1] * [X17] * [X20] * [X23] * [X21] CE ←
```

NOTE: For commands and examples of computer or device responses mentioned in this guide, the character “Ø” is used for the number zero and “o” represents the capital letter “o.”

Computer responses and directory paths that do not have variables are written in the font shown here:

```
Reply from 208.132.180.48: bytes=32 times=2ms TTL=32  
C:\Program Files\Extron
```

Variables are written in slanted form as shown here:

```
ping xxx.xxx.xxx.xxx -t  
SOH R Data STX Command ETB ETX
```

Selectable items, such as menu names, menu options, buttons, tabs, and field names are written in the font shown here:

```
From the File menu, select New.  
Click the OK button.
```

Specifications Availability

Product specifications are available on the Extron website, www.extron.com.

Extron Glossary of Terms

A glossary of terms is available at <http://www.extron.com/technology/glossary.aspx>.

Contents

Introduction..... 1

About This Guide.....	1
About the IN1604 DTP and IN1604 HD Scalers	1
Key Features	2
Video.....	2
Audio.....	3
General.....	3
Controlling the Scaler	5

Installation..... 6

Rear Panel Connections	6
Power and Input Connections.....	7
Output Connections	8
Control Connections.....	10
Connection Details	11
Analog Video Wiring	11
HDMI Connections	11
Twisted Pair Recommendations for DTP Communication	12

Operation..... 13

Front Panel Overview.....	13
Powering Up	14
Input Selection.....	14
Output Resolution Change	14
Auto-Image from the Front Panel	14
Front Panel Lockout (Executive Modes)	14
Power Save Mode.....	14
Firmware Reset	14
On-Screen Display (OSD) Menu System	15
Menu Navigation Using Front Panel Controls.....	15
Menu Overview.....	15
Quick Setup Submenu.....	17
User Presets Submenu.....	18
Picture Controls Submenu.....	19
Input Submenu.....	20

Output Submenu	22
Audio Submenu.....	24
Advanced Submenu	25
Communication Submenu	27
Device Info Submenu.....	28

SIS Configuration and Control..... 29

Host and Scaler Communication	29
Scaler-Initiated Messages	29
Error Responses.....	29
SIS Overview	30
Using the Command and Response Tables.....	30
Symbol Definitions	30
Command and Response Tables.....	35
Input Configuration Commands	35
Picture Adjustment Commands	38
Preset Commands.....	40
Output Configuration Commands	41
Audio Configuration Commands.....	43
Advanced Configuration Commands	44
On-Screen Menu Configuration Commands	47
Device Commands	47

Configuration Software..... 49

Software Installation.....	49
Software Connection	50
Device Discovery Panel.....	51
Offline Device Preview.....	52
Software Overview.....	53
Software Menu	53
Device Menu.....	55
AV Controls Panel.....	59
AV Inputs Buttons.....	59
Auto-Image Button	59
Freeze Button	59
Mute Buttons.....	59

Configuration Pages 60
 Input and Output Configuration Page..... 60
 EDID Minder Page 63
 Image Settings Page..... 65
 Size and Position Page 69
 Audio Configuration Page 70
 Preset Management Page 72
 General Settings Page 73

Reference Information 77

Mounting 77
 Tabletop Mounting..... 77
 Rack Mounting 77
 Furniture Mounting..... 78
Downloading Updated Firmware..... 79

Introduction

This section provides general information about this guide and the IN1604 DTP Scaler with DTP Extension and the IN1604 HD Scaler with HDMI output. Topics in this section include:

- [About This Guide](#)
- [About the IN1604 DTP and IN1604 HD Scalers](#)
- [Key Features](#)
- [Controlling the Scaler](#)

About This Guide

This guide contains information about installing, operating, and configuring the IN1604 DTP Scaler with DTP Extension and the IN1604 HD Scaler with HDMI output. In this guide, the term “IN1604 DTP” refers to the IN1604 DTP Scaler with DTP Extension, “IN1604 HD” refers to the IN1604 HD Scaler with HDMI output, and “scalers” refer to both models.

About the IN1604 DTP and IN1604 HD Scalers

The scalers are HDCP-compliant video scalers with three HDMI inputs and a universal analog video input in a compact 1U, half rack enclosure. The IN1604 DTP includes a DTP output while the IN1604 HD includes an HDMI output. The scalers are ideal for installation beneath conference tables and in lecterns to provide localized switching support for sources such as presenter devices. The IN1604 DTP also supports signal extension up to 330 feet (100 meters) over shielded twisted pair cable to reach a wall or ceiling-mounted display. The scalers provide the convenience of fast and reliable automatic switching, along with a high performance scaling engine for HDMI and analog video sources. They also include a host of audio processing features and many versatile options for control and configuration.

The following diagram shows the IN1604 DTP mounted under a table with four inputs and one output.

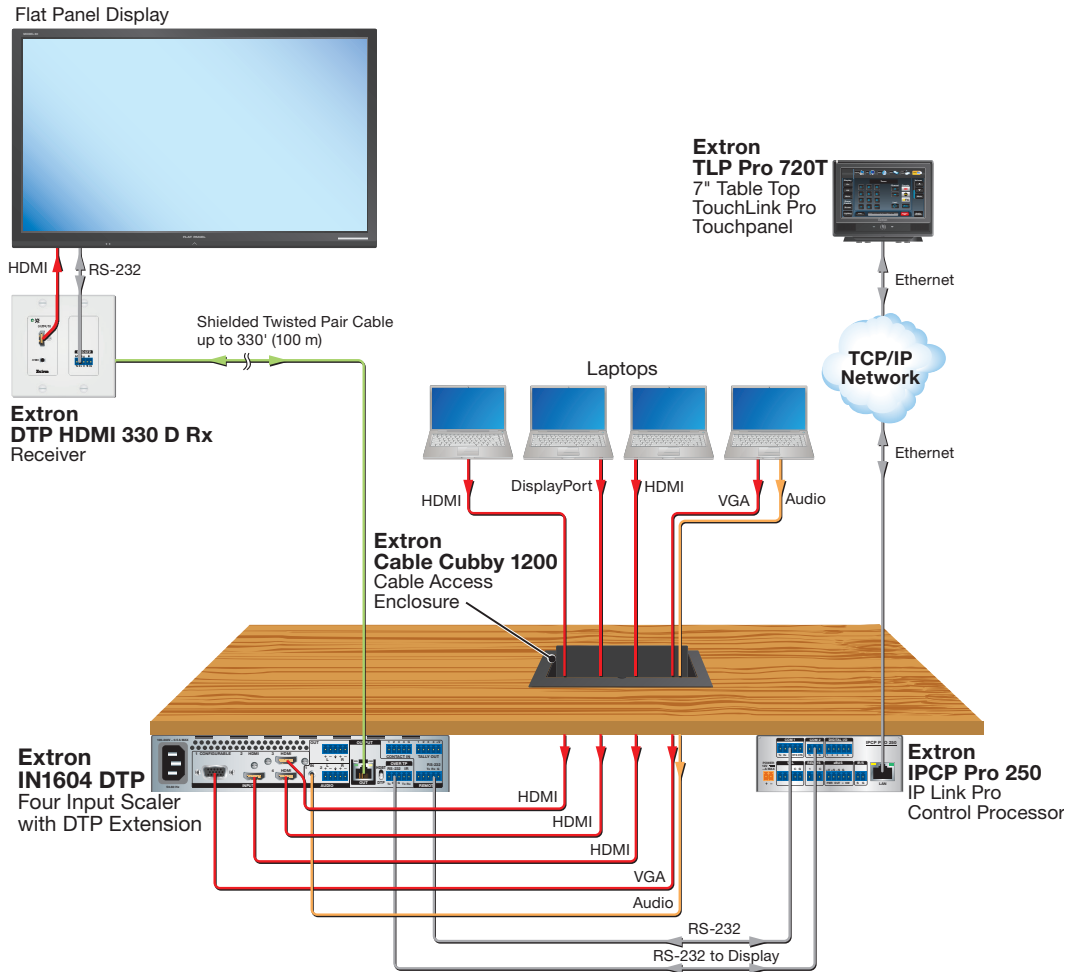

Figure 1. Typical IN1604 DTP Application Diagram

Key Features

Video

- **Three HDMI inputs and one configurable analog video input** — Allow for switching between HDMI and analog video sources. One configurable analog input accepts most standard analog video formats, including RGB, HD component video, S-video, and composite video signals.
- **HDMI, analog video, and audio source integration into presentation systems with audio switching** — Provides centralized switching for a wide range of AV sources.
- **Interface format correction** — Automatically reformats HDMI source signals for output to a connected DVI display.
- **Auto-switching between inputs** — Enhances presentations by eliminating distractions during switching with glitch-free cut through black and fade through black transition effects.
- **Selectable output rates** — Include computer-video output rates from 640x480 to 1920x1200, HDTV rates up to 1080p/60, and 2K.

- **Integrated DTP output (IN1604 DTP only)** — Supports digital signal transmission of HDMI or DVI plus control and analog audio up to 330 feet (100 meters) over a single shielded twisted pair cable, providing high reliability and maximum performance on an easily installed cable infrastructure.
- **HDMI output (IN1604 HD only)** — Provides one HDMI output.

Audio

- **One stereo balanced/unbalanced audio input on captive screw and one unbalanced stereo audio input on a 3.5 mm stereo mini jack** — Allows flexible audio switching with two individually assignable analog audio inputs.
- **Audio input gain and attenuation** — Gain or attenuation can be adjusted for each analog input to eliminate noticeable differences when switching between sources.
- **Audio input assignment** — Enables all four video inputs to share a single analog audio input. Each video input can be assigned to either of the two available analog audio inputs.
- **Audio switching transition** — Lowers the audio of the switched-out source while simultaneously bringing up the audio of the activated source. The duration of the audio crossfade matches the duration of the video switching transition.
- **Automatic integrated audio delay** — Compensates for latency introduced by the video processing.
- **HDMI audio embedding** — Embeds analog audio signals onto the DTP or HDMI output.
- **HDMI audio de-embedding** — Extracts embedded HDMI two-channel PCM audio to the analog output, or multi-channel bitstream formats that can be passed to the output.
- **Output volume control** — Provides master volume control for the audio output.
- **Selectable audio muting** — Individually or simultaneously mutes the analog and embedded digital audio outputs.

General

- **Supported HDMI specification features** — Includes data rates up to 6.75 Gbps, Deep Color, and HD lossless audio formats.
- **HDCP-compliance** — Fully supports HDCP-encrypted sources, with selectable authorization for unencrypted content.
- **HDCP authentication and signal presence confirmation** — Provides real-time verification of HDCP status for each digital video input and output. This allows for quick signal and HDCP verification through RS-232, USB, or front panel LED indicators, providing feedback to a system operator or helpdesk support staff.
- **HDCP Visual Confirmation** — Sends a full-screen green signal when HDCP-encrypted content is transmitted to a non-HDCP compliant display, providing immediate visual confirmation that protected content cannot be viewed on the display.
- **Bidirectional RS-232 and IR insertion for AV device control (IN1604 DTP only)** — Transmits RS-232 control and IR signals alongside the video signal over DTP connection, allowing the remote device to be controlled without the need for additional cabling. Bidirectional control extension eliminates the need for control system wiring to remote devices.
- **Support for integrated DTP output (IN1604 DTP only)** — Supports transmission of HDMI, control, and analog audio up to 330 feet (100 meters) over a shielded twisted

pair cable, providing high reliability and maximum performance on an easily installed cable infrastructure.

- **Remote powering of a DTP receiver (IN1604 DTP only)** — Provides power to a remote DTP receiver over the twisted pair connection, eliminating the need for a separate power supply at the remote unit.
- **DTP 230 and DTP 330 compatibility (IN1604 DTP only)** — Enables mixing and matching with desktop and wallplate receivers, as well as other DTP-enabled products to meet application requirements.
- **HDBaseT compatibility (IN1604 DTP only)** — Allows the TP output to be configured to send video and embedded audio, plus bidirectional RS-232 and IR signals to an HDBaseT-enabled display.

NOTE: When configured for HDBaseT mode, “Over DTP” analog audio and remote power capabilities are disabled.

- **Key Minder** — Authenticates and maintains continuous HDCP encryption between input and output devices to ensure quick and reliable switching in professional AV environments, while enabling simultaneous distribution of a single source signal to one or more displays.
- **Advanced scaling engine** — Scales inputs to a common high resolution output with 30-bit processing and 1080i deinterlacing.
- **EDID Minder** — Ensures that all sources power up properly and reliably output content for display.
- **SpeedSwitch Technology** — Provides high-speed switching for HDCP-encrypted content.
- **Aspect ratio control** — Controls the aspect ratio by selecting a Fill mode, which provides a full screen output, or a Follow mode, which preserves the original aspect ratio of the input signal.
- **Image freeze control** — Freezes a live image.
- **Automatic input cable equalization** — Actively conditions incoming HDMI signals to compensate for signal loss when using long cables, low quality cables, or source devices with poor signal output.
- **Auto-Image** — Automatically optimizes the image by analyzing and adjusting to the video input signal.
- **Auto Input Memory** — Automatically stores size, position, and picture settings based on the incoming signal. When the same signal is detected again, these image settings are automatically recalled from memory.
- **On-screen menus** — Allows for easy system setup using the front panel controls. Key parameters such as input and output video formats and resolutions are grouped on the initial Quick Setup screen, while additional screens provide full control over other functions and settings.
- **Output Standby Mode** — Mutes video and sync output to the display device when no active input signal is detected. This allows the projector or flat-panel display to automatically enter into standby mode to save energy and enhance lamp or panel life.
- **Power Save Mode** — Places the scaler in a low power standby state to conserve energy when not in use.
- **Picture controls** — Includes controls for brightness, contrast, color, tint, detail, horizontal and vertical positioning, and sizing.

- **Automatic 3:2 and 2:2 pulldown detection** — Helps maximize image detail and sharpness for NTSC, PAL, and HDTV 1080i sources that originated from film.
- **Quad standard, 3D composite video decoding** — Provides advanced decoding of composite NTSC 3.58, NTSC 4.43, PAL, and SECAM for integration into systems worldwide using a temporal 3D adaptive comb filter.
- **User presets** — Store optimized image settings to be recalled later.
- **Internal test patterns** — Include a crop pattern, grayscale, color bars, alternating pixels, blue mode, and audio pink noise for calibration and setup.
- **Front panel security lockout (executive modes)** — Locks out all or some front panel functions. Full controls remain available through the Extron Product Configuration Software, USB, or RS-232 control.
- **Contact closure remote control with tally output** — Allows for remote selection of an input channel, while a tally output provides +5 VDC to light an LED to indicate the currently selected input.
- **RS-232 control port** — Enables the use of serial commands for complete control and configuration via an integrated control system. Extron products use the Simple Instruction Set (SIS) command protocol, a set of basic ASCII commands that allow for quick and easy programming.
- **Front panel USB configuration port** — Enables easy configuration without having to access the rear panel.
- **Compact 1U, half rack width metal enclosure** — Allows for inconspicuous under-table placement using the optional mounting kits.
- **Includes LockIt HDMI cable lacing brackets**
- **Internal universal power supply** — The 100-240 VAC, 50-60 Hz international power supply provides worldwide power compatibility.

Controlling the Scaler

The scaler can be controlled using one or more of the following methods:

- The front panel controls and the On-screen Display (OSD) menu (see [Operation](#) on page 13).
- A computer, a touch screen panel, or any other device that can send and receive serial communications through the USB or RS-232 port. Use the Extron DataViewer utility on the connected device to enter SIS commands (see [SIS Configuration and Control](#) on page 29).
- The Extron Product Configuration Software (PCS) on a computer with a Windows® operating system (see [Configuration Software](#) on page 49).

Installation

This section contains information on how to connect cables to the scalars. Topics in this section include:

- [Rear Panel Connections](#)
- [Connection Details](#)

Rear Panel Connections

The IN1604 DTP and IN1604 HD have many of the same connectors. Figure 2 shows the different output connectors and the different arrangement of the remote connectors on the scalars.

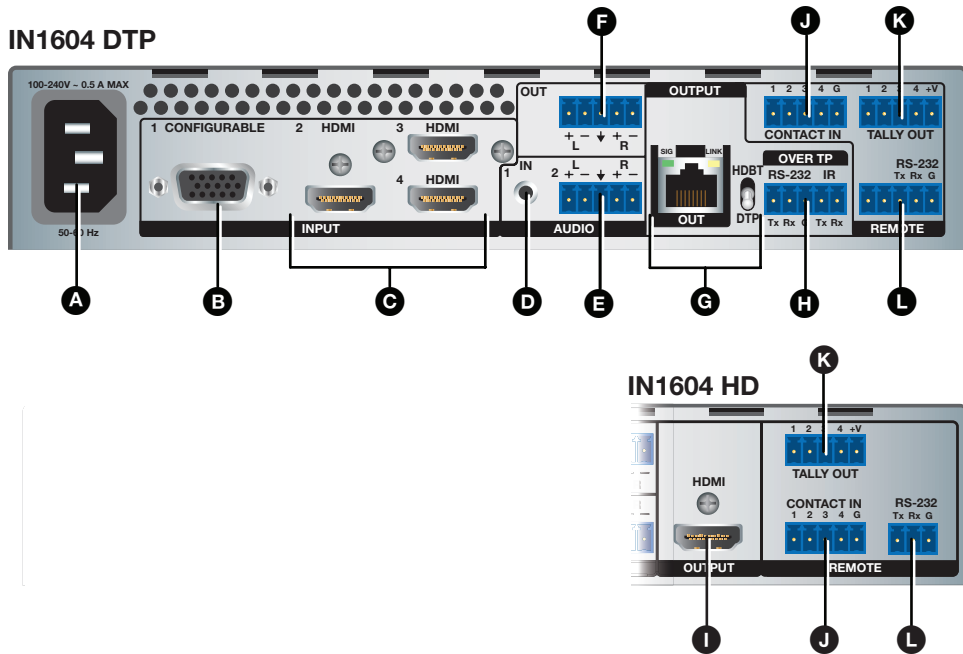

Power and Input Connections	Output Connections	Control Connections
<p>A AC power connector</p> <p>B Configurable Analog video connector — input 1</p> <p>C HDMI input connectors — inputs 2-4</p> <p>D Analog audio input connector — input 1</p> <p>E Analog audio input connector — input 2</p>	<p>F Analog audio output connector</p> <p>G TP output connector and TP output switch (IN1604 DTP only)</p> <p>H RS-232 and IR Over TP output connector (IN1604 DTP only)</p> <p>I HDMI output connector (IN1604 HD only)</p>	<p>J Contact closure connector</p> <p>K Tally output connector</p> <p>L Remote RS-232 connector</p>

Figure 2. IN1604 DTP and IN1604 HD Rear Panel Connectors

Power and Input Connections

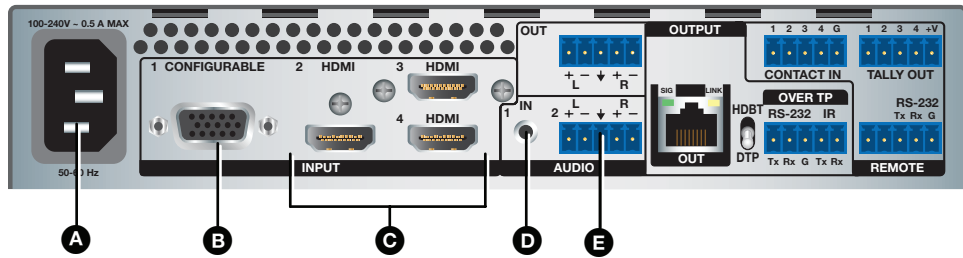
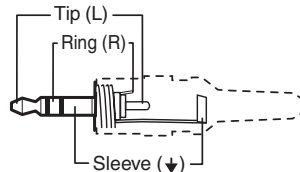

Figure 3. Power and Input Connectors (IN1604 DTP Shown)

- A Power connector** — Connect the standard IEC power cord from a 100 to 240 VAC, 50-60 Hz power source into this connector. The front panel control and input selection buttons light in sequence during power-up.
- B Configurable analog video connector** — Connect a video source to the 15-pin HD connector. It accepts RGB, YUV, S-video, and composite video (see [Analog Video Wiring](#) on page 11).
- C HDMI input connectors** — Connect video sources to the HDMI connectors.

TIP: Use Extron HDMI LockIt Lacing Brackets to secure HDMI cables to the device (see [HDMI Connections](#) on page 11).

- D Analog audio input connector** — Connect an audio source to the 3.5 mm tip-ring-sleeve (TRS) connector for unbalanced analog audio.



3.5 mm Stereo Plug Connector (unbalanced)

Figure 4. TRS Wiring

- E Analog audio input connector** — Connect an audio source to the 5-pole captive screw connector. Wire the connector for line level, balanced or unbalanced, analog stereo.

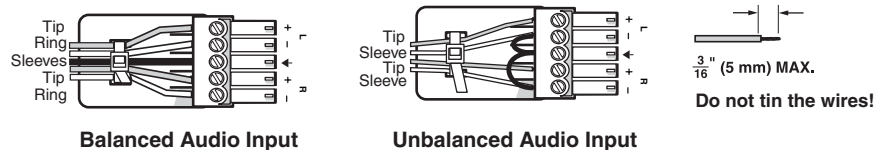

Figure 5. Audio Input Connector Wiring

Output Connections

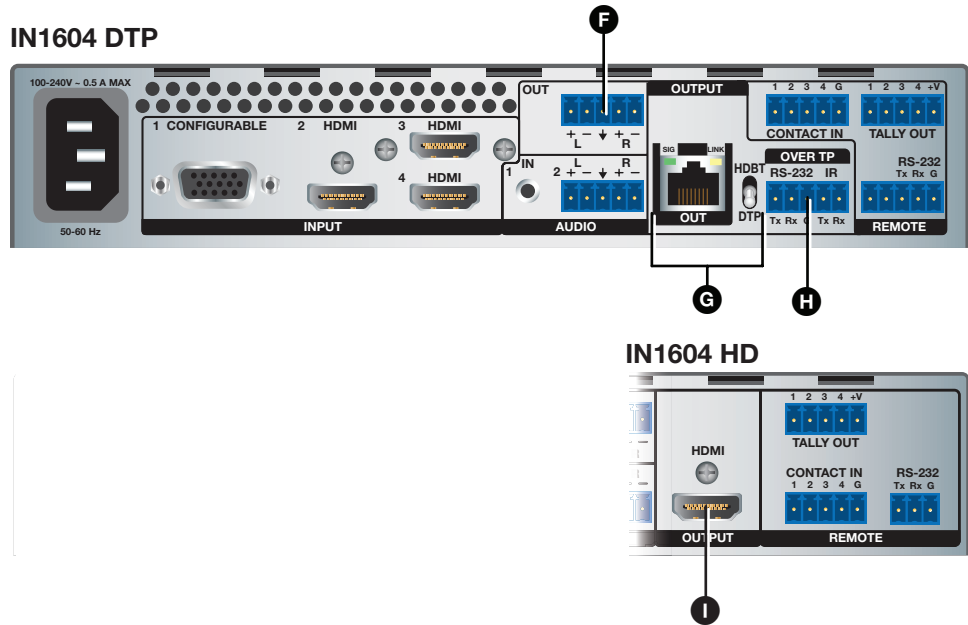

Figure 6. Output Connectors

- F Analog audio output connector** — Connect audio output devices to this 5-pole captive screw connector. Wire the connector for line level, balanced or unbalanced, analog stereo.

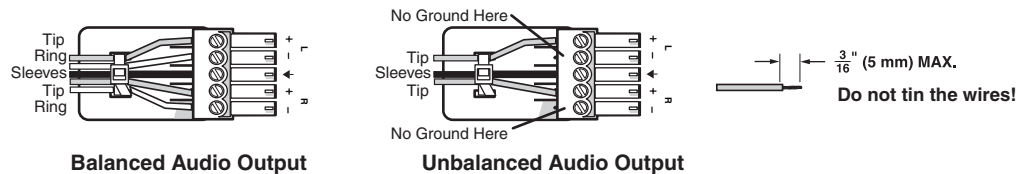

Figure 7. Audio Output Connector Wiring

- G TP output connector and TP output switch (IN1604 DTP only)** — Connect a DTP receiver or HDBaseT-enabled device to the TP output RJ-45 connector to send all signals over a single twisted pair cable (see [Twisted Pair Recommendations for DTP Communication](#) on page 12 for wiring and cable recommendations).

Use the recessed switch to the right of the connector to set the signal type to the type of receiver connected to the TP output connector. Position the switch up to send HDBaseT signals. Position the switch down to send DTP signals.



ATTENTION: Position this switch BEFORE connecting the appropriate device to the TP connector. Failure to comply can damage the endpoint.

ATTENTION : Positionnez ce interrupteur AVANT d'alimenter le point de connexion connecté. Ne pas respecter cela pourrait endommager le point de connexion.

This connection supports the following:

- HDCP-compliant digital video and audio
- RS-232 and IR pass-through signals on the associated 5-pole captive screw connectors
- “Over DTP” analog audio (DTP mode only)
- Remote power to a DTP receiver (DTP mode only)

ATTENTION:

- Do not connect this connector to a computer or telecommunications network.
- Ne connectez pas ce port à des données informatiques ou à un réseau de télécommunications.
- DTP remote power is intended for indoor use only. No part of the network that uses DTP remote power should be routed outdoors.
- L'alimentation DTP à distance est destinée à une utilisation en intérieur seulement. Aucune partie du réseau qui utilise l'alimentation DTP à distance ne peut être routée en extérieur.

Signal LED — Lights when the scaler is receiving an active video signal from a DTP receiver.

Link LED — Lights when a valid link is established to a DTP receiver.

- Ⓜ **RS-232 Over TP port (IN1604 DTP only)** — To pass bidirectional serial control between DTP-compatible or HDBaseT-compatible devices, connect a control device to the 5-pole captive screw connector. This port includes only the 3 poles labeled “RS-232.”

IR Over TP port (IN1604 DTP only) — To transmit and receive IR signals, connect a control device to the 5-pole captive screw connector. This port includes only the 2 poles labeled “IR” and shares the ground pole with the RS-232 port.

NOTE: RS-232 and IR data can be transmitted simultaneously.

- ① **HDMI output connector (IN1604 HD only)** — Connect a display device to the HDMI output connector. Use this connector for a local monitor to display the On-screen Display (OSD) menu (see [Operation](#) on page 13).

Control Connections

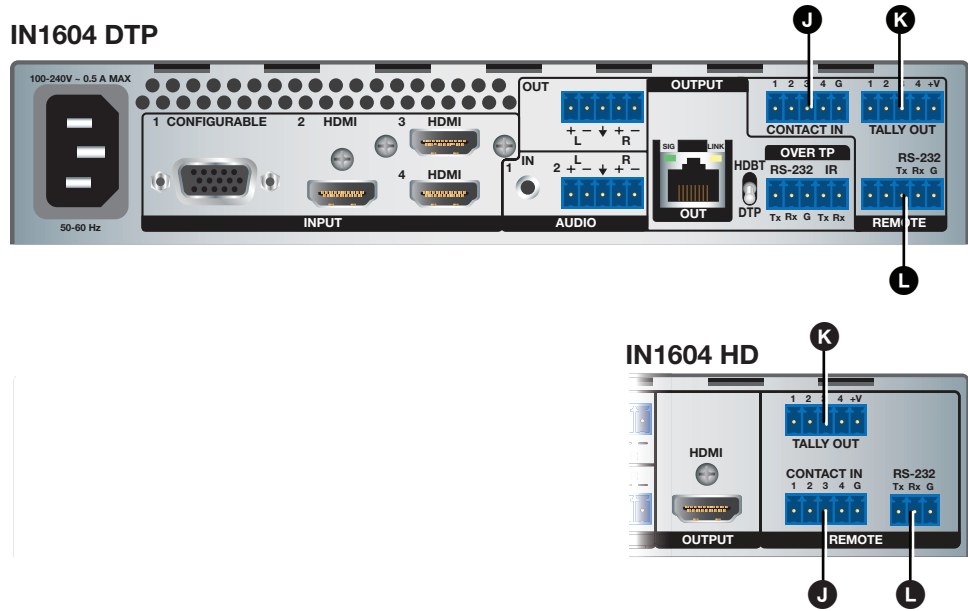

Figure 8. Control Connectors

- J Contact closure input connector** — Connect Extron “Show Me” cables or a locally-constructed contact closure device to the 5-pole captive screw connector. The four left ports (1, 2, 3, and 4) are used to select inputs 1 through 4 when momentarily shorted to the ground port. The closure accepts a momentary or latching contact.

NOTES:

- If there is a conflict between a request to change inputs from another method and the contact closure is currently held closed by a latch, the input does not switch.
- Auto switch mode must be disabled. To disable auto switch mode, use the OSD menu (see **Auto Switch** on page 27), SIS commands (see the **Auto switch mode** commands on page 46), or PCS (see **Auto Switch panel** on page 76).

In conjunction with the Tally port, the currently selected input can be indicated (see **Remote Tally port** below).

- K Remote Tally port** — If desired, to remotely identify the currently selected input, plug a locally-constructed device into the 5-pole captive screw connector. Connect the power wire for the device into the +V pin and connect the ground wire for the each indicator into the corresponding tally out pin, 1, 2, 3, or 4.

When an input is selected, by either contact closure of front panel selection, the corresponding tally out pin shorts to ground, closing the circuit and lighting the connected indicator (LED).

This connector can also be used with Extron “Show Me” cables and the Contact Closure input connector. For each “Show Me” cable, connect the red pigtail to the associated pin of the Contact Closure input connector and the black pigtail to the associated pin on the Tally Out connector (see the diagram to the right). For more information and installation details for the Extron “Show Me” cable, see the “*Show Me*” *Cable Series Setup Guide* at www.extron.com.

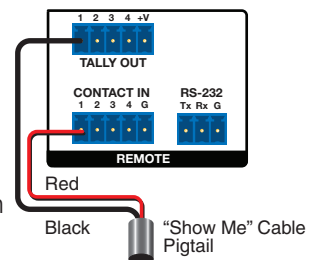

- L Remote RS-232 connector** — Connect a host device to the three rightmost poles of the 5-pole captive screw connector for RS-232 serial control. The scaler uses a protocol of 9600 baud, 1 stop bit, no parity, and no flow control.

Connection Details

Analog Video Wiring

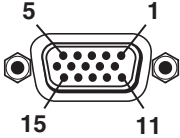
Pinout Table for 15-pin HD Connectors					
Pin	RGBHV	RGBs	Component	S-video	Composite
1	Red	Red	R-Y		
2	Green	Green	Y	Luma	Video
3	Blue	Blue	B-Y	Chroma	
4					
5	H Sync Return	C Sync Return			
6	Red Return	Red Return	R-Y Return		
7	Green Return	Green Return	Y Return	L Return	Video Return
8	Blue Return	Blue Return	B-Y Return	C Return	
9					
10	V Sync Return/ DDC Return	DDC Return			
11					
12	EDID/DDC	EDID/DDC			
13	H Sync	C Sync			
14	V Sync				
15	EDID/DDC	EDID/DDC			

HDMI Connections

Use an Extron LockIt lacing bracket to secure an HDMI cable to each device.

1. Plug the HDMI cables into the panel connection (see ❶ of the image to the right).
2. Loosen the side HDMI connection mounting screw from the panel enough to allow the LockIt lacing bracket to be placed over it (❷). The screw does not have to be removed.
3. Place the LockIt lacing bracket on the screw and against the HDMI connector, then tighten the screw to secure the bracket (❸).

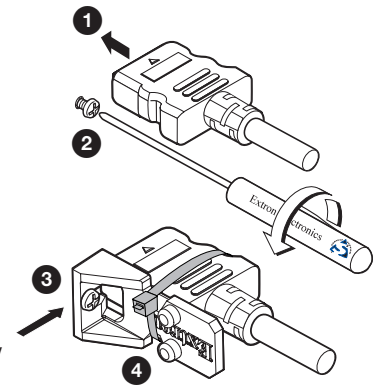

ATTENTION: Do not overtighten the HDMI connector mounting screw. The shield to which it is fastened is very thin and can easily be stripped.

ATTENTION : Ne serrez pas trop la vis de montage du connecteur HDMI. Le blindage auquel elle est attachée est très fin et peut facilement être dénudé.

4. Loosely place the included tie wrap around the HDMI connector and the LockIt lacing bracket (❹).
5. While holding the connector securely against the lacing bracket, use pliers or a similar tool to tighten the tie wrap, then remove any excess length.

The LockIt bracket can also be used in a stacked formation, as shown right.

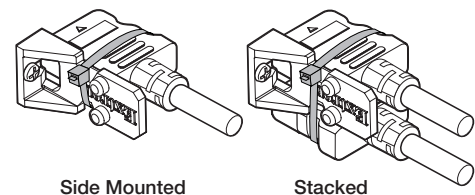

Twisted Pair Recommendations for DTP Communication

Use the following pin configurations for twisted pair cables.

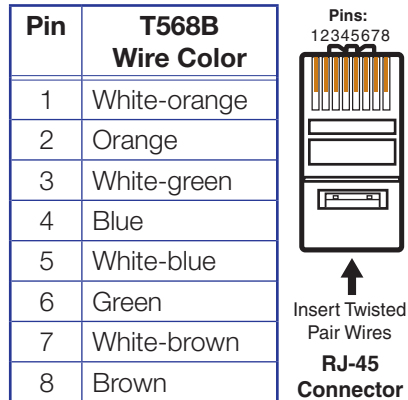

Figure 9. Twisted Pair Cable Configuration

Supported cables

The scalars are compatible with shielded twisted pair (F/UTP, SF/UTP, and S/FTP) and unshielded twisted pair (U/UTP) cable.

ATTENTION: Do not use Extron UTP23SF-4 Enhanced Skew-Free AV UTP cable or STP201 cable to link the device with DTP transmitters or receivers.

ATTENTION : N'utilisez pas le câble AV Skew-Free UTP version améliorée UTP23SF d'Extron ou le câble STP201 pour relier le appareil avec les émetteurs ou les récepteurs DTP.

Cable recommendations

Extron recommends using the following practices to achieve full transmission distances and reduce transmission errors.

- Use the following Extron XTP DTP 24 SF/UTP cables and connectors for the best performance:
 - **XTP DTP 24/1000** Non-Plenum 1000' (305 m) spool 22-236-03
 - **XTP DTP 24P/1000** Plenum 1000' (305 m) spool 22-235-03
 - **XTP DTP 24 Plug** Package of 10 101-005-02
- If not using XTP DTP 24 cable, at a minimum, Extron recommends 24 AWG, solid conductor, STP cable with a minimum bandwidth of 400 MHz.
- Terminate cables with shielded connectors to the TIA/EIA-T568B standard.
- Limit the use of more than two pass-through points, which may include patch points, punch down connectors, couplers, and power injectors. If these pass-through points are required, use shielded couplers and punch down connectors.

NOTE: When using shielded twisted pair cable in bundles or conduits, consider the following:

- Do not exceed 40% fill capacity in conduits.
- Do not comb the cable for the first 20 meters, where cables are straightened, aligned, and secured in tight bundles.
- Loosely place cables and limit the use of tie wraps or hook-and-loop fasteners.
- Separate twisted pair cables from AC power cables.

Operation

This section contains information on the front panel operation, On-screen Display Menu System, and reset modes of the scalers. Topics in this section include:

- [Front Panel Overview](#)
- [Powering Up](#)
- [Input Selection](#)
- [Output Resolution Change](#)
- [Auto-Image from the Front Panel](#)
- [Front Panel Lockout \(Executive Modes\)](#)
- [Power Save Mode](#)
- [Firmware Reset](#)
- [On-Screen Display \(OSD\) Menu System](#)

Front Panel Overview

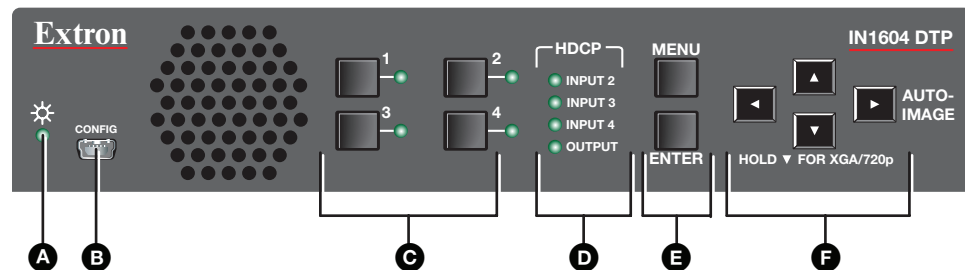

Figure 10. Front Panel Features (IN1604 DTP Shown)

- A Power LED indicator** — Lights green when the scaler is receiving power and an input signal. Lights amber when it is receiving only power.
- B Config port** — Connect a host device to the USB mini-B connector.
- C Input selection buttons and LED indicators** — Press one of these buttons to select an input. The buttons light when the input is selected.
- D HDCP status LED indicators** — Light when the HDMI input or the output is HDCP-compliant.
- E Menu and Enter buttons** — Press this button to enter the OSD menu system, select options, or exit the OSD menu system.
- F Navigation buttons** — Press any of the four buttons to navigate the OSD menu system or change values of adjustable settings.

Powering Up

When power is applied to the scaler, the Input selection buttons light green before illuminating just the selected input.

Input Selection

Press any of the Input selection buttons on the front panel to select an input.

Output Resolution Change

When the On-screen Display (OSD) menu system is not active, press and hold (for about 5 seconds) the **Down (▼)** button to toggle between 1024x768 @ 60 Hz and 720p @ 60 Hz output rates.

Auto-Image from the Front Panel

When the OSD menu system is not active, press the **Right (▶)** button to activate a one-time Auto-Image. When asked to confirm the Auto-Image, press the **Right (▶)** button again to confirm or wait until the message disappears to cancel the Auto-Image. This feature is not available when the scaler is in Front Panel Lockout mode 1, but is available when the scaler is in Front Panel Lockout mode 2.

Front Panel Lockout (Executive Modes)

The scalers have three modes of front panel security lock that limit the operation of the device from the front panel. When a Front Panel Lockout mode is enabled, all functions and adjustments can still be made through USB or RS-232 control (see [SIS Configuration and Control](#) on page 29 or [Configuration Software](#) on page 49).

Front Panel Lockout mode 0 (disabled) — Unlocks front panel functions. To enable this mode, press and hold the **Menu** and **Enter** button for about 5 seconds. This is the default setting.

Front Panel Lockout mode 1 (enabled) — Locks all front panel functions completely. This mode can be enabled or disabled only by SIS commands (see the [Front Panel Lockout mode commands](#) on page 45).

Front Panel Lockout mode 2 (enabled) — Locks all front panel functions except input switching and Auto-Image. To enable this mode, press and hold the **Menu** and **Enter** buttons for about 5 seconds.

The menu system returns to the default menu within 10 seconds.

Power Save Mode

The scalers have a Power Save mode that allows the device to enter a low power state. This mode can only be turned on or off with SIS commands (see [Power Save mode](#) on page 41).

NOTE: Video output and DTP communication are disabled in Power Save mode. It may take some time for DTP communication to resume after Power Save mode is turned off.

Firmware Reset

Press and hold the **Enter** button for about 20 seconds while applying power to reset the device to factory default settings, including the original factory firmware. Previously loaded firmware is deleted and only the factory firmware remains on the device.

NOTE: To reset user settings only and retain the current firmware version, use the OSD menu (see [Factory Reset](#) on page 27), SIS commands (see the [Reset](#) SIS command on page 47), or PCS (see [Reset Device](#) on page 56).

On-Screen Display (OSD) Menu System

The OSD menu is used primarily when the scaler is initially set up. Configuration and adjustments can also be performed with SIS commands (see [SIS Configuration and Control](#) on page 29) or the Product Configuration Software (see [Configuration Software](#) on page 49). The OSD menu presents configuration options on a local monitor and can be adjusted with front panel controls.

Menu Navigation Using Front Panel Controls

Menu button — Press the **Menu** button to activate or exit the OSD menu, deselect a submenu, or cancel a pending change.

Enter button — Press the **Enter** button to activate the OSD menu, select submenus or submenu items, or accept pending changes.

Navigation buttons — Press the **Up** (▲) button or the **Down** (▼) button to navigate submenus or submenu items. Press the **Right** (▶) button to access currently selected submenus or submenu items. Press the **Left** (◀) button to exit currently selected submenus or submenu items. Also use the navigation buttons to adjust settings according to specific setting directions.

NOTE: The **Down** button can be used when the OSD is inactive to quickly change the output resolution between several rates.

Input selection buttons — Press any of the input selection buttons to change the selected input.

Menu Overview

In the OSD menu, the firmware version is displayed in the top border. The active input settings and output resolution are displayed in the bottom border. The OSD menu contains nine submenus with various submenu items of adjustable settings or device information. Use the Menu, Enter, and Navigation buttons to navigate the OSD menu.

To open the OSD menu:

1. Connect a display device to an HDMI output connector on a DTP receiver connected to an IN1604 DTP (see [figure 2](#), **G** on page 6) or the HDMI output connector on an IN1604 HD (see [figure 2](#), **I** on page 6).
2. Press the **Menu** or **Enter** button to open the OSD menu.

To navigate the OSD menu:

1. Press the **Up** or **Down** button to navigate the nine submenus. The following table shows the nine submenus and their respective submenu items.

Submenus	Submenu Items							
Quick Setup	Auto-Image	Input Format	EDID	Audio	Output Resolution	Aspect Ratio	Audio Mute	Test Pattern
User Presets	Recall	Save	Clear					
Picture Controls	Image Position	Image Size	Brightness/Contrast	Color/Tint	Detail			
Input	Auto-Image	Input Format	Film Mode	Horizontal/Vertical Start	Horizontal/Vertical Active	Total Pixels/Phase	HDCP Authorization	EDID
Output	Output Resolution	HDMI Format	HDCP Notification					
Audio	Audio Mute	Audio Format	Analog Gain/Attenuation	Output Format	Output Volume			
Advanced	Test Pattern	Screen Saver/Timeout	Auto-Image	Aspect Ratio	Auto Memory	Overscan	Auto Switch	Factory Reset
Communication	Remote Port	Contact Mute/Tally LED						
Device Info (Read Only)	Temperature	Input Information	Output Information	HDCP Status	Display Information	Firmware Version		

2. Press the **Enter** or **Right** button to open submenu items.
3. Press the **Up** or **Down** button to navigate the submenu items.
4. Press the **Menu** button to exit a submenu item or return to the previous submenu.

To adjust a submenu item:

1. Navigate to an adjustable item and press the **Enter** or **Right** button to select the submenu item.
2. Press the **Left** or **Right** button to select a submenu item or a specific adjustable setting within the selected submenu item.

If the selected submenu item has multiple adjustable settings, press the **Up** or **Down** button to select a value.

3. Press the **Enter** button to accept the new value.

Press the **Menu** button to cancel any pending changes.

To exit the OSD menu:

Hold the **Menu** button for 3 seconds to exit the OSD menu.

Quick Setup Submenu

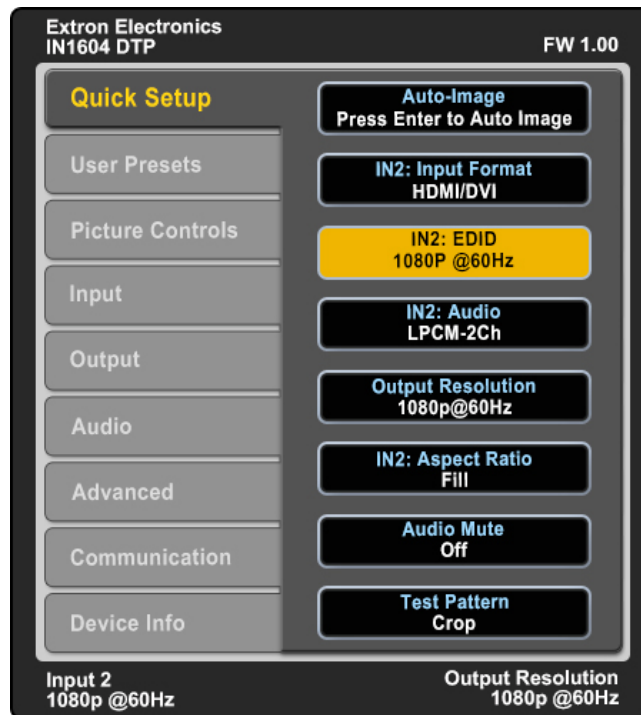

Figure 11. Quick Setup Submenu

The **Quick Setup** submenu allows quick access to common input, output, and communication settings. This submenu contains the following submenu items:

Auto-Image — Press the **Enter** button to execute an Auto-Image on the current input (see [Auto-Image](#) on page 20).

Input Format — Press the navigation buttons to select the desired video input format (see [Input Format](#) on page 21). The current input is displayed in the title of the submenu.

Input EDID — Press the navigation buttons to select a discrete EDID or match the output resolution (see [EDID](#) on page 21). The current input is displayed in the title of the submenu.

Input Audio Format — Press the navigation buttons to select an audio format (see [Audio Format](#) on page 24).

Output Resolution — Press the navigation buttons to select from a list of output resolutions and refresh rates (see [Output Resolution](#) on page 23). There are five custom options, prefaced by C1 through C5. The default setting is 720p @ 60 Hz.

Input Aspect Ratio — Press the navigation buttons to select the aspect ratio for the current input (see [Aspect Ratio](#) on page 26).

Audio Mute — Press the navigation buttons to globally mute or unmute the audio.

Test Pattern — Press the navigation buttons to select an available test pattern to display or to turn a test pattern off (see [Test Pattern](#) on page 25). The available test patterns are Crop, Alternating Pixels, Crosshatch, Color Bars, Grayscale, Blue Mode, and Audio Test Pattern (pink noise). The default setting is Off.

User Presets Submenu

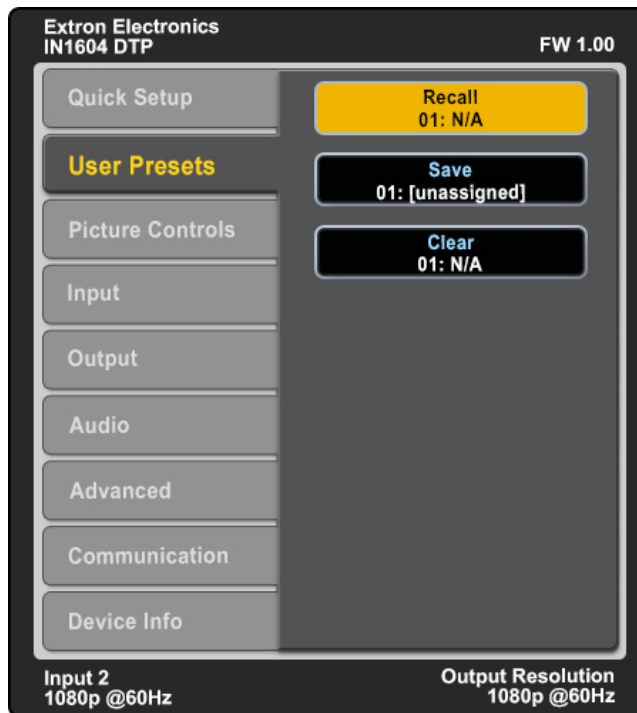

Figure 12. User Presets Submenu

The User Presets submenu allows the current picture control settings (see [Picture Controls Submenu](#) on page 19) for the selected input to be saved, a user preset to be recalled, or a user preset to be erased. User presets can be saved and recalled later on another input, allowing them to also be used as aspect ratio or discrete size and center shortcuts. There are 16 user presets available per input. Press the Input Selection buttons to select an input.

NOTE: If a saved preset is not named, “User Preset XX” is assigned (XX represents the preset number).

From the Recall, Save, or Clear submenu item, press the navigation buttons to select the desired preset to either save picture control settings, recall previously saved picture control settings, or reset a preset.

User presets save the following settings:

- Brightness and contrast
- Color and tint
- Detail
- Image size and position
- Preset name

NOTE: This submenu is for user presets only. To save and recall input presets, use SIS commands (see [Preset Commands](#) on page 40) or the Configuration Software (see [Preset Management Page](#) on page 72).

Picture Controls Submenu

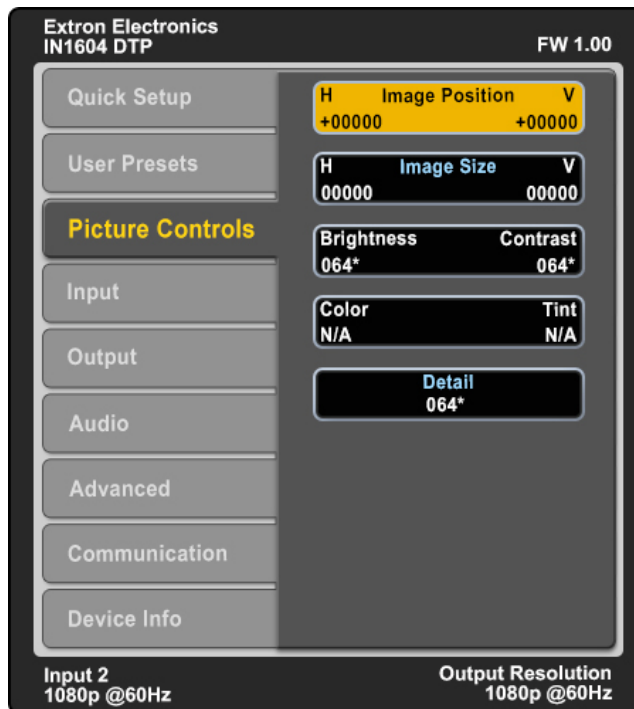

Figure 13. Picture Controls Submenu

The **Picture Controls** submenu allows adjustment of picture settings.

NOTE: Picture control settings are saved in user presets (see [User Presets Submenu](#) on page 18). They are also saved in input presets along with other settings. To save and recall input presets, use SIS commands (see [Preset Commands](#) on page 40) or the Configuration Software (see [Preset Management Page](#) on page 72).

Image Position — Press the **Left** and **Right** buttons to adjust the horizontal (H) position of the image. Press the **Up** and **Down** buttons to adjust the vertical (V) position of the image.

Image Size — Press the **Left** and **Right** buttons to adjust the horizontal (H) size of the image. Press the **Up** and **Down** buttons to adjust the vertical (V) size of the image.

Brightness and Contrast — Press the **Left** and **Right** buttons to adjust the brightness level of the image. Press the **Up** and **Down** buttons to adjust the contrast of the image.

Color and Tint — Press the **Left** and **Right** buttons to adjust the color of the image. Press the **Up** and **Down** buttons to adjust the tint of the image. These settings are only applicable to analog NTSC, PAL, and SECAM signals.

Detail — Press the navigation buttons to adjust the detail of the image.

Input Submenu

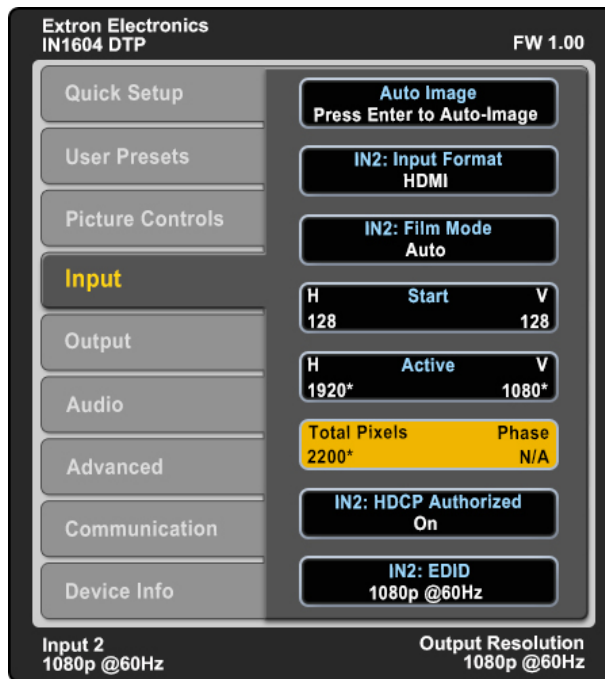

Figure 14. Input Submenu

The Input submenu allows adjustment of the active input.

Auto-Image — Press the **Enter** button to execute an Auto-Image on the active input. Auto-Image updates active pixel, active lines, horizontal and vertical start, phase, horizontal and vertical image position, and horizontal and vertical image size settings.

For analog video sources with dark backgrounds or borders, the Auto-Image threshold can be adjusted with SIS commands. Raising the Auto-Image threshold ignores potential extraneous sync pulses that may have been embedded in RGB signals (see **Auto-Image threshold value** on page 35). Lowering the threshold can allow for more accurate sizing and centering on dark video sources (such as a dark PC desktop).

The following is performed during an Auto-Image when the aspect ratio is set to Fill:

- Horizontal and vertical image position return to 0.
- Horizontal and vertical image size fill to match the current output resolution.

The following is performed during an Auto-Image when the aspect ratio is set to Follow:

- The horizontal and vertical image position and image size is set to maintain the native aspect of the input rate with regard to the current output resolution.

Set the aspect ratio on the Advanced submenu (see **Aspect Ratio** on page 26).

NOTE: Aside from the standard Auto-Image SIS command (see the **Auto-Image SIS commands** on page 35), there are unique commands to execute an Auto-Image and fill the output and to execute an Auto-Image and maintain the input aspect ratio. These commands ignore the current aspect mode setting, auto-image the input, and then apply a “fill” or “follow.”

Input Format — Press the navigation buttons to select an analog video input format for inputs 1 and 2. All other inputs are digital inputs for HDMI or DVI input signals. The following table shows the available formats for each input.

Input 1	Input 2	Input 3	Input 4
RGB (default)	HDMI (default)	HDMI (default)	HDMI (default)
YUV			
S-Video			
Composite			

NOTE: Input 1 does not automatically detect the format.

Film Mode — Press the navigation buttons to turn Film Mode 3:2 and 2:2 detection on (auto detect mode) or off.

Start — Press the **Left** and **Right** buttons to adjust the horizontal (H) pixel start value. Press the **Up** and **Down** buttons to adjust the vertical (V) pixel start value. This applies to analog inputs only.

Active — Press the **Left** and **Right** buttons to adjust the horizontal (H) active pixels. Press the **Up** and **Down** buttons to adjust the vertical (V) active pixels. This applies to analog inputs only.

Total Pixels and Phase — Press the **Left** and **Right** buttons to adjust the total pixels of the image. Press the **Up** and **Down** buttons to adjust the phase of the image. This applies to analog inputs only.

HDCP Authorized — Press the navigation buttons to enable or disable the HDCP Authorized feature. This feature determines if a digital input will report as an HDCP authorized sink to a source.

For source devices that require encryption, enable HDCP Authorized. If HDCP Authorized is disabled for sources that require encryption (for example, a Blu-ray player), the output is muted or a warning message is displayed.

Some source devices may encrypt their output even if the source material does not require HDCP encryption, preventing content from being displayed on a non-HDCP compliant display. Disable HDCP Authorized to allow the output of the scaler to remain unencrypted.

EDID — Press the navigation buttons to select an EDID for the active input. Select a discrete EDID from a list of factory-supplied EDID or select **Match Output** to use the output resolution and refresh rate (see **Output Resolution** on page 23 for a full list of available resolution and refresh rates).

Output Submenu

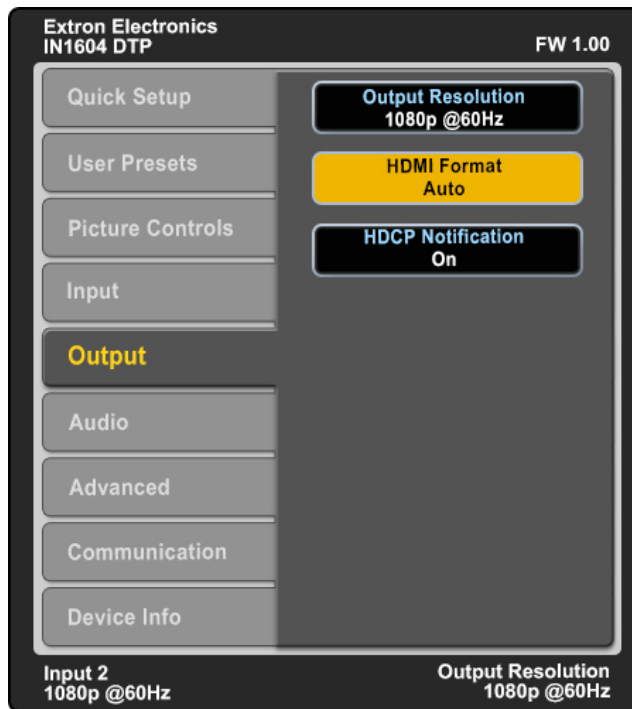

Figure 15. Output Submenu

The **Output** submenu allows configuration of the output resolution, refresh rate, HDMI format, and HDCP notification.

Output Resolution — Press the navigation buttons to change the resolution and refresh rate from the select list. The table on page 21 shows the available resolution and refresh rates.

Resolution	23.98 Hz	24 Hz	25 Hz	29.97 Hz	30 Hz	50 Hz	59.94 Hz	60 Hz
640x480								X
800x600								X
1024x768								X
1280x768								X
1280x800								X
1280x1024								X
1360x768								X
1366x768								X
1440x900								X
1400x1050								X
1600x900								X
1680x1050								X
1600x1200								X
1920x1200								X
480p							X	X
576p						X		
720p			X	X	X	X	X	X*
1080i						X	X	X
1080p	X	X	X	X	X	X	X	X
2K (2048x1080)	X	X	X	X	X	X	X	X
Custom 1 through 5	For captured or uploaded EDID tables							

* Default

NOTE: The five custom, user-defined output rates default to 720p @ 60 Hz when no custom EDID is captured or uploaded.

HDMI or DTP Output Format — Press the navigation buttons to set the output format. The following formats are available:

- Auto (based on display EDID)
- DVI RGB 444
- HDMI RGB 444 Full
- HDMI RGB 444 Limited
- HDMI YUV 444 Full
- HDMI YUV 444 Limited
- HDMI YUV 422 Full
- HDMI YUV 422 Limited

HDCP Notification — Press the navigation buttons to enable or disable an HDCP compliance notification. When the HDCP notification is enabled or on and an HDCP-encrypted input is sent to a display that is non-compliant, a green background is displayed with a moving message reading “HDCP Content.” If HDCP notification is disabled or off, a black or muted output is displayed.

Audio Submenu

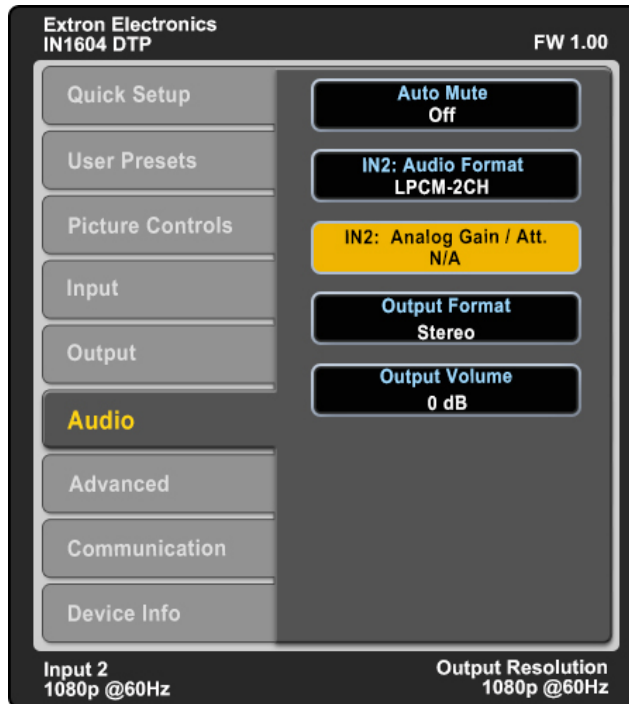

Figure 16. Audio Submenu

The **Audio** submenu allows adjustment of audio settings, including mute, input format, gain and attenuation, output format, and volume.

Audio Mute — Press the navigation buttons to globally mute or unmute audio output.

Audio Format — Press the navigation buttons to select the audio input format. Input 1 can only be set to **None**, **Analog 1**, or **Analog 2**. Inputs 2-4 can be set for any audio input format (see the table below for a description of the formats).

Format	Details	Inputs
None	Mutes audio for the selected input. Sets “No Audio” EDID.	All
Analog 1	Sets the selected input to analog input 1. Sets “No Audio” EDID.	All
Analog 2	Sets the selected input to analog input 2. Sets “No Audio” EDID.	All
LPCM-2Ch	Sets the selected input to LPCM-2Ch audio. Sets 2Ch audio EDID.	2-4
Multi-Ch	Sets the selected input to Multi-Ch audio. Sets Multi-Ch audio EDID.	2-4
LPCM-2Ch Auto (Analog 1)	Sets the selected input prioritize 2-channel LPCM audio. Audio on analog input 1 is passed when 2-channel LPCM audio is not present. Sets 2Ch audio EDID.	2-4
Multi-Ch Auto (Analog 1)	Sets the selected input to prioritize multi-channel audio, but will pass 2-channel LPCM if multi-channel audio is not available. Audio from analog input 1 is passed when digital is not present. Sets Multi-Ch audio EDID.	2-4
LPCM-2Ch Auto (Analog 2)	Sets the selected input prioritize 2-channel LPCM audio. Audio on analog input 2 is passed when 2-channel LPCM audio is not present. Sets 2Ch audio EDID.	2-4
Multi-Ch Auto (Analog 2)	Sets the selected input prioritize multi-channel audio, but will pass 2-channel LPCM if multi-channel audio is not available. Audio on analog input 2 is passed when digital audio is not present. Sets 2Ch audio EDID.	2-4

Analog Gain and Attenuation — Press the navigation buttons to set the gain (in dB) for the applicable analog input.

Output Format — Press the navigation buttons to set the output format.

Output Volume — Press the navigation buttons to set the audio output volume.

Advanced Submenu

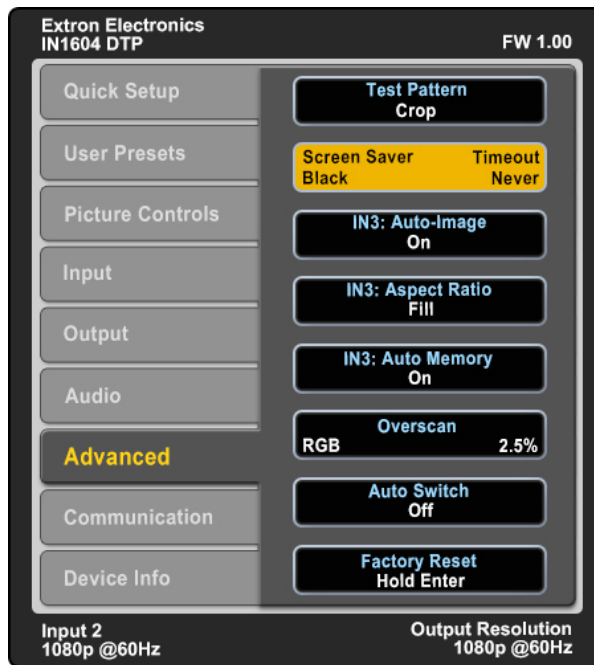

Figure 17. Advanced Submenu

The Advanced submenu allows adjustment of test patterns, screen saver mode, automatic Auto-Image, aspect ratio, auto memory, overscan settings, auto switch, and factory reset.

Test Pattern — Press the navigation buttons to select a test pattern to display or to turn off a test pattern. The available test patterns are Crop, Alternating Pixels, Crosshatch, Color Bars, Grayscale, Blue Mode, and Audio Test (pink noise). The default setting is Off.

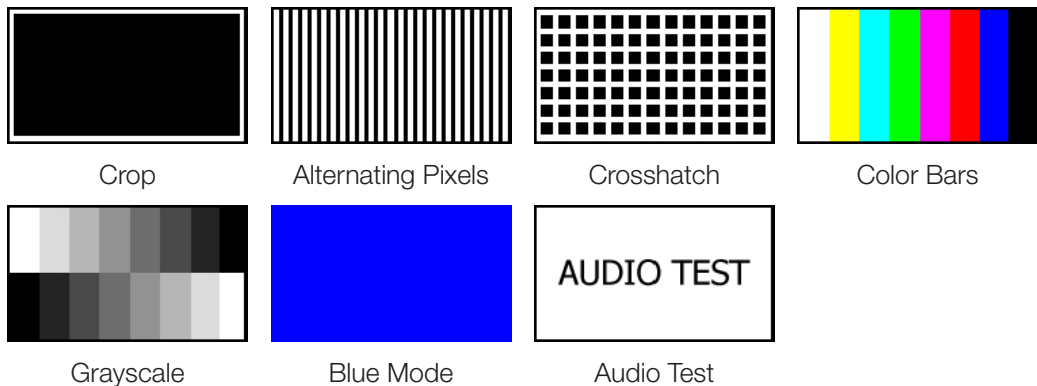

Figure 18. Available Test Patterns

NOTES:

- The audio test outputs pink noise on the embedded digital audio output (2-channel, 48 kHz, 16 bit).
- All test patterns include a single pixel border (except Blue mode).
- All test patterns remain enabled after a power cycle.

Screen Saver and Timeout — Press the **Left** and **Right** buttons to select the screen saver setting: **Black** (default) or **Blue**. Press the **Up** or **Down** buttons to set the duration (in seconds) the screen saver remains active before sync is disabled.

When there is no active video on the selected input, the device can mute the video output to black or blue for a set duration before disabling output sync. By default, the scaler outputs black video and sync (no sync time-out) with no active input applied.

The time-out duration can be set to **Never** (default) or to any duration from 1-500 seconds.

Auto-Image — Press the Navigation buttons to turn the automatic per-input Auto-Image mode on or off (default).

When enabled and a new input frequency is detected, the scaler first applies an existing auto memory for the signal (if auto memory is enabled). If no entry exists, it performs an automatic Auto-Image on the new signal. This sets a size and position for the image to fill the screen, with respect to the current Aspect Ratio setting.

By default, the Auto-Image threshold is 25% brightness. Analog video signals greater than the threshold are considered active video. To change the threshold value, use SIS commands (see **Auto-Image threshold value** on page 35).

Aspect Ratio — Press the Navigation buttons to set the aspect ratio setting of the active input to **Fill** (default) or **Follow**. The scaler clears the previous size and position settings whenever the aspect ratio setting for an input is adjusted.

When in Fill mode, all inputs automatically fill the entire output. For an adjustment to the aspect ratio of a single input rate, use change the image size and position in the Picture Controls submenu (see **Picture Controls Submenu** on page 19). If auto memory is enabled, these settings are saved and recalled the next time the signal is detected.

In Follow mode, each input rate is displayed with its native aspect ratio mode with the correct letter box or pillar box settings visible.

Auto Memory — Press the Navigation buttons to turn auto memory on or off for each input. The scaler stores 32 auto memories per input, with input configuration and picture control data for each video resolution. The default setting enables these memories to automatically recall input and picture controls for previously applied signals. When auto memories are disabled, the scaler treats every applied signal as a new source.

Auto Memory and Auto-Image Interaction		
Auto Memory	Auto-Image	Information
On	On	“New” signals and rates not previously detected by the scaler are set up using default parameters, then Auto-Image is automatically applied. The next time the signal is detected, the values stored in the auto memory location are applied.
On (default)	Off (default)	“New” signals and rates not previously detected by the scaler are set up using default parameters. If manual input or picture settings are made, an auto memory location is created and recalled each time the input is detected.
Off	On	Each change in input sync, input switch, or power cycle triggers an automatic Auto-Image. When auto memory is disabled, each change in sync is treated as a new signal. Manual changes made to the image and picture controls are lost each time a new rate is detected.
Off	Off	Each change in input sync causes default values to be applied. Manual changes made to the image and picture controls are lost when a new rate is applied, a new input is applied, or after a power cycle.

Overscan — Press the navigation buttons to select the overscan value for each input format. Choose between **0%**, **2.5%**, or **5%**. Set default overscan mode through SIS commands (see the **Overscan mode** SIS commands on page 45).

Overscan is specific to each input signal type. This feature zooms and crops SMPTE input resolutions to mask edge effects and ancillary data that are common in broadcast signals. When the overscan mode is not at 0%, an Auto-Image on a SMPTE input rate (NTSC, PAL, SECAM, 480p, 576p, 720p, 1080i, 1080p, and 2K [2048x1080]) refers to the default input lookup table values instead of performing a “true” auto image.

NOTE: Overscan is valid only on SMPTE input rates (NTSC, PAL, 480p, 576p, 720p, 1080i, 1080p, or 2K [2048x1080]) and is global for each video format.

Auto Switch — Press the navigation buttons to turn the auto switch mode on or off, and to set the priority. The auto switch setting allows for basic, unmanaged, input switching based on the presence of active input signals. Auto switch mode options are:

- Disabled (off)
- Setting priority to “high to low” (highest numbered active input to the lowest)
- Setting priority to “low to high” (lowest numbered active input to the highest)

Factory Reset — Press and hold the **Enter** button until the message “Factory Reset” is displayed over the OSD menu to clear all user settings but retain the current firmware. The “Factory Reset” message is displayed over the OSD menu for 1 minute after the reset to allow time for the display device to sync with the scaler output.

NOTE: The Factory Reset is the same as performing the ZXXX SIS command (see the **Reset** command on page 47).

Communication Submenu

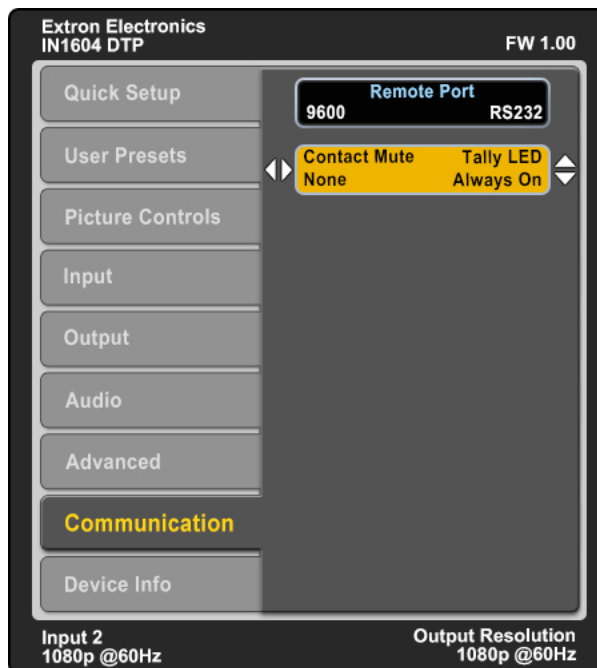

Figure 19. Communication Submenu

The **Communication** submenu displays RS-232 settings and allows contact closure and tally LED configuration.

Remote Port — Displays the Baud rate for the serial RS-232.

Contact Mute and Tally LED — Press the **Left** and **Right** buttons to select contact closure mute mode. Press the **Up** and **Down** buttons to select the tally LED action.

Contact Mute options:

- **None** — The initial contact closure provides input switching to the corresponding input. Any additional button presses or contact closures on the input have no additional effect.
- **A/V Mute** — Once an input is selected, additional contact closure pulses mutes or unmutes audio and video on the output.
- **Sync Mute** — Once an input is selected, additional contact closure pulses mutes or unmutes audio and video sync on the output.

Tally LED options:

- **Always On** — The LED on the corresponding tally output pin to the selected input remains lit at all times.
- **Mute Off** — The LED on the corresponding tally output pin to the selected input turns off when video or sync is muted; otherwise, the LED remains lit.
- **Mute Blink** — The LED on the corresponding tally output pin to the selected input blinks when video or sync is muted; otherwise, the LED remains lit.

Device Info Submenu



Figure 20. Device Info Submenu

The **Device Info** submenu displays device information including internal temperature, input and output signal information, HDCP status, display information, and firmware version. This submenu does not contain any adjustable submenu items.

SIS Configuration and Control

The scaler can be configured and controlled with Extron Simple Instruction Set (SIS) commands when connected to a host computer or other device (such as a control system). Attach the host device to the rear panel RS-232 connector or the front panel USB port. Commands can be entered using a Telnet application such as the Extron DataViewer, available at www.extron.com (see the *DataViewer Help* file for more details). RS-232 connection uses a protocol of 9600 baud, 1 stop bit, no parity, and no flow control. The protocol cannot be adjusted. This section describes SIS communication and control. Topics in this section include:

- [Host and Scaler Communication](#)
- [SIS Overview](#)
- [Command and Response Tables](#)

Host and Scaler Communication

SIS commands consist of one or more characters per field. No special characters are required to begin or end a command sequence. When the scaler determines that a command is valid, it executes the command and sends a response to the host device. All responses from the scaler to the host end with a carriage return and a line feed (CR/LF = `↵`), indicating the end of the response character string (one or more characters).

Scaler-Initiated Messages

When a local event such as a front panel selection or adjustment takes place, the scaler responds by sending a message to the host. No response is required from the host. Example scaler-initiated messages are listed here.

- In `[x1] A11↵` (where `[x1]` is the input number during an input switch).
- `Reconfig↵` The scaler sends this response when an input is switched or when a new signal is detected.
- `Hp1g0[x2]↵` The scaler sends this response when a hot plug event on output `[x2]` is detected.

Error Responses

When the scaler receives a valid command, it executes the command and sends a response to the host device. If the unit is unable to execute the command, it returns an error response to the host.

E01 — Invalid input number	E13 — Invalid parameter
E06 — Invalid switch attempt in this mode	E14 — Not valid for this configuration
E10 — Invalid command	E17 — Invalid command for signal type
E11 — Invalid preset number	E22 — Busy
E12 — Invalid port number	

SIS Overview

Using the Command and Response Tables

The **Command and Response Tables** for SIS commands beginning on page 35 lists the commands that the scaler recognizes as valid, the responses that are returned to the host, a description of the command function or the results of executing the command, and examples of commands in ASCII (Telnet) and URL encoded (Web).

NOTE: Upper and lower case text can be used interchangeably unless otherwise stated.

	ASCII to Hex Conversion Table																Esc	1B	CR	ØD	LF	ØA
Space →	20	!	21	"	22	#	23	\$	24	%	25	&	26	'	27							
(28)	29	*	2A	+	2B	,	2C	-	2D	.	2E	/	2F							
Ø	30	1	31	2	32	3	33	4	34	5	35	6	36	7	37							
8	38	9	39	:	3A	;	3B	<	3C	=	3D	>	3E	?	3F							
@	40	A	41	B	42	C	43	D	44	E	45	F	46	G	47							
H	48	I	49	J	4A	K	4B	L	4C	M	4D	N	4E	O	4F							
P	50	Q	51	R	52	S	53	T	54	U	55	V	56	W	57							
X	58	Y	59	Z	5A	[5B	\	5C]	5D	^	5E	_	5F							
.	60	a	61	b	62	c	63	d	64	e	65	f	66	g	67							
h	68	i	69	j	6A	k	6B	l	6C	m	6D	n	6E	o	6F							
p	70	q	71	r	72	s	73	t	74	u	75	v	76	w	77							
x	78	y	79	z	7A	{	7B		7C	}	7D	~	7E	DEL	7F							

Figure 21. ASCII to Hexadecimal Character Conversion Table

Symbol Definitions

- = Space
- ↵ = Carriage return with line feed
- ← = Carriage return with no line feed
- | = Pipe (can be used interchangeably with the ← character)
- Esc** = Escape
- W = Can be used interchangeably with the **Esc** character
- X1** = Input selection
 - 1 = configurable VGA
 - 2 = HDMI or DVI input 1
 - 3 = HDMI or DVI input 2
 - 4 = HDMI or DVI input 3
- X2** = Input video format
 - 1 = RGB
 - 2 = YUV
 - 3 = S-video
 - 4 = composite
 - 5 = HDMI/DVI
- X3** = Horizontal or vertical start Ø- 255 (128 = default)
- X4** = Pixel phase Ø- 63 (31 = default)
- X5** = Total lines ±512 of the default value
- X6** = Total pixels ±512 of the default value
- X7** = Active pixels ±512 of the default value
- X8** = Active lines ±256 of the default value

X9	= Enable or disable	∅ = off or disabled 1 = on or enabled
X10	= Input standard	∅ = no signal detected on the current input 1 = NTSC 3.85 2 = PAL 3 = NTSC 4.43 4 = SECAM - = Not applicable (occurs when the input is active RGB, YUV, or HDMI signal)
X11	= Internal temperature	In degrees Celsius
X12	= Horizontal and vertical frequencies	xxx.x
X13	= Text label	Up to 16 characters but cannot contain the following: \ / : * ? < > ”
X14	= Picture adjustment	∅-127 (64 = default)
X15	= Horizontal position	±2∅48
X16	= Vertical position	±12∅∅
X17	= Horizontal size	1∅-4∅96
X18	= Vertical size	1∅-24∅∅
X19	= Test patterns	∅ = off (default) 1 = crop 2 = alternating pixels 3 = crosshatch 4 = color bars 5 = grayscale 6 = blue mode 7 = audio test (pink noise)
X20	= User presets	1-16
X21	= Input presets	1-16
X22	= Screen saver timeout	∅ = OSD is never displayed, output sync is instantly disabled with no active input 1-5∅∅ = 1 second increments 5∅1 = Output sync never times out (default)
X23	= Front Panel Lockout mode status	∅ = off or disabled (default) 1 = mode 1 (complete front panel lockout) 2 = mode 2 (only allow input switching and Auto-Image)
X24	= Verbose mode	∅ = clear or none 1 = verbose mode 2 = tagged responses 3 = verbose mode and tagged responses
X25	= Device name	Text label up to 24 characters drawn from the alphabet (A-Z), digits (0-9), and the minus or hyphen symbol (-).
X26	= Overscan	∅ = 0.0% (default for RGB, HDMI) 1 = 2.5% (default for YUV, S-video, and CV) 2 = 5.0%
X27	= Aspect ratio setting	1 = fill (default) 2 = follow

X28	=	Screen saver mode	1 = black output (default) 2 = blue output with OSD text
X29	=	Video output mute	0 = unmute 1 = mute video 2 = mute video and sync
X30	=	Auto-Image threshold value	0 - 100 (where 0 = black and 100 = white; 025 = default)
X31	=	HDCP status	0 = no sink or source device detected 1 = sink or source detected with HDCP 2 = sink or source detected but no HDCP
X32	=	Video switching effect	0 = cut 1 = fade through black (default)
X33	=	HDCP mode	0 = HDMI outputs are always authenticated, but only encrypted when required 1 = HDMI outputs are always authenticated and encrypted 2 = HDMI outputs are always authenticated, but only encrypted when required, with continuous DVI trials 3 = HDMI outputs are always authenticated and encrypted, with continuous DVI trials
X34	=	TMDS output format	0 = auto (based on the display EDID: default) 1 = DVI RGB 444 2 = HDMI RGB "Full" 3 = HDMI RGB "Limited" 4 = HDMI YUV 444 "Full" 5 = HDMI YUV 444 "Limited" 6 = HDMI YUV 422 "Full" 7 = HDMI YUV 422 "Limited"
X35	=	Auto switch mode	0 = disable 1 = prioritizes the highest numbered active input 2 = prioritizes the lowest numbered active input
X36	=	Audio volume	-100 to 0 in 1 dB steps (where -100 = -100 DB and 0 = 0 dB; -10 = default)
X37	=	Audio output format	1 = dual mono 2 = stereo (default)
X38	=	Audio input gain	-18 to +24 in dB (0 = default)
X39	=	Audio input format	0 = none (input muted) 1 = analog 1 (TRS) 2 = analog 2 (captive screw) 3 = LPCM-2Ch digital 4 = Multi-Ch digital 5 = LPCM-2Ch digital auto (analog 1) 6 = Multi-Ch digital auto (analog 1) 7 = LPCM-2Ch digital auto (analog 2) 8 = Multi-Ch digital auto (analog 2)
X40	=	EDID file	128 or 256 bytes of binary data
X41	=	Video signal status	0 = video or HDMI signal not detected 1 = video or HDMI signal detected
X42	=	Power Save mode	0 = full power mode (default) 1 = lower power state

X43	=	Screen saver status	<ul style="list-style-type: none"> ∅ = active input detected, timer not running 1 = no active input, timer running, output sync still active 2 = no active input, timer expired, output sync disabled
X44	=	HDCP authorization status	<ul style="list-style-type: none"> ∅ = block HDCP encryption 1 = allow HDCP encryption (default)
X45	=	DTP output format	<ul style="list-style-type: none"> ∅ = DTP format (default) 1 = HDBaseT format
X46	=	AV mute mode	<ul style="list-style-type: none"> ∅ = normal operation (default) — no mute occurs, switches to input designated by Contact-In port, no further action taken if already on the input specified) 1 = perform video and audio mute — enable or disable during subsequent Contact-In action if already on the input specified 2 = perform video sync and audio mute — enable or disable during subsequent Contact-In action if already on the input specified
X47	=	Mute LED mode	<ul style="list-style-type: none"> ∅ = always on (default) — Tally Out port will remain enabled for the corresponding selected input choice 1 = off when muted — Tally Out port for the corresponding currently selected input will be off when video mute is enabled; otherwise, it will be On 2 = blink when muted — Tally Out port for the corresponding currently selected input will blink when video sync mute is enabled; otherwise, it will be On
X48	=	Audio output mute	<ul style="list-style-type: none"> 1 = local 5-pole captive screw connector and remote 5-pole remote (DTP) captive screw connector 2 = embedded TMDS audio output

X49 = EDID emulation or output rate

∅ = automatic (matches the current output resolution; default)

1 = output (available for EDID export only)

2∅1 = custom EDID or output rate 1

2∅2 = custom EDID or output rate 2

2∅3 = custom EDID or output rate 3

2∅4 = custom EDID or output rate 4

2∅5 = custom EDID or output rate 5

SIS Variables for EDID Resolution and Refresh Rate Combinations (where X49 = 10-53)								
Resolution	23.98 Hz	24 Hz	25 Hz	29.97 Hz	30 Hz	50 Hz	59.94 Hz	60 Hz
640x480								1∅
800x600								11
1024x768								12
1280x768								13
1280x800								14
1280x1024								15
1360x768								16
1366x768								17
1440x900								18
1400x1050								19
1600x900								2∅
1680x1050								21
1600x1200								22
1920x1200								23
480p							24	25
576p						26		
720p			29	3∅	31	32	33	34
1080i						35	36	37
1080p	38	39	4∅	41	42	43	44	45
2048x1080 (2K)	46	47	48	49	5∅	51	52	53

Command and Response Tables

Command	ASCII Command (host to scaler)	Response (scaler to host)	Additional Description
Input Configuration Commands			
Input selection			
Select input	[X1]!	In[X1]•A11←	Select input [X1].
View current input	!	[X1]←	View the current input.
Input video format			
Set video format	[X1]*[X2]\	Typ[X1]*[X2]←	Set input [X1] to format [X2].
View set format	[X1]\	[X2]←	View the video format.
Input EDID (VGA and HDMI)			
Assign EDID	[Esc]A[X1]*[X49]EDID←	EdidA[X1]*[X49]←	Set the EDID [X49] to input [X1].
View assigned EDID	[Esc]A[X1]EDID←	[X49]←	View the EDID for input [X1].
Save an output EDID to custom slot	[Esc]S1*[X49]EDID←	Edids1*[X49]←	Save output EDID to [X49].
Auto-Image			
Enable	1*1A	Img1*1←	Activate Auto-Image for input 1.
Disable	1*∅A	Img1*∅←	Turn off Auto-Image for input 1.
View	1A	[X9]← Img1*[X9]←	View the Auto-Image setting for input 1. Verbose mode 2 and 3
Execute	A	Img∅←	Execute an Auto-Image for the current input (follows the aspect ratio of the current input).
Execute and fill	1*A	Img1←	Execute an Auto-Image and fill the output.
Execute and follow	2*A	Img2←	Execute an Auto-Image and maintain the aspect ratio of the current input.
Auto-Image threshold value (luminosity value which the scaler defines as active video for Auto-Image)			
Set value	[Esc][X30]ALVL←	A1v1[X30]←	Set the global Auto-Image luminosity to [X30].
View	[Esc]ALVL←	[X30]←	View the global Auto-Image luminosity.

NOTES:

[X1] = Input selection

[X2] = Input video format

[X9] = Enable or disable

[X30] = Auto-Image threshold value

[X49] = EDID emulation

1 = configurable VGA

2 = HDMI or DVI input 1

3 = HDMI or DVI input 2

4 = HDMI or DVI input 3

∅ = No input detected

1 = RGB (input 1 only)

2 = YUV (input 1 only)

3 = S-video (input 1 only)

5 = HDMI (inputs 2-4 only)

∅ = off or disabled

1 = on or enabled

∅-1∅∅ (where ∅ = black and 1∅∅ = white; 25 = default)

See the [X49] [definition](#) on page 34.

Command	ASCII Command (host to scaler)	Response (scaler to host)	Additional Description
Horizontal start			
Specify a value	[Esc] [X3] HSRT ←	Hsrt [X1] * [X3] ↵	Set the horizontal start position.
Increment value	[Esc] +HSRT ←	Hsrt [X1] * [X3] ↵	Increase the horizontal start position by one.
Decrement value	[Esc] - HSRT ←	Hsrt [X1] * [X3] ↵	Decrease the horizontal start position by one.
View	[Esc] HSRT ←	[X3] ↵	View the horizontal start position.
Vertical start			
Specify a value	[Esc] [X3] VSRT ←	Vsrt [X1] * [X3] ↵	Set the vertical start position.
Increment value	[Esc] +VSRT ←	Vsrt [X1] * [X3] ↵	Increase the vertical start position by one.
Decrement value	[Esc] - VSRT ←	Vsrt [X1] * [X3] ↵	Decrease the vertical start position by one.
View	[Esc] VSRT ←	[X3] ↵	View the vertical start position.
Pixel phase (available only for RGB and YUV-HD input signals)			
Specify a value	[Esc] [X4] PHAS ←	Phas [X1] * [X4] ↵	Set the pixel phase to [X4] on the current input.
Increment value	[Esc] +PHAS ←	Phas [X1] * [X4] ↵	Increase the pixel phase setting by one on the current input.
Decrement value	[Esc] - PHAS ←	Phas [X1] * [X4] ↵	Decrease the pixel phase setting by one on the current input.
View	[Esc] PHAS ←	[X4] ↵	View the pixel phase setting on the current input.
Total pixels (available only for RGB and YUV-HD input signals)			
Specify a value	[Esc] [X6] TPIX ←	Tpix [X1] * [X6] ↵	Set the total pixels to [X6] on the current input.
Increment value	[Esc] +TPIX ←	Tpix [X1] * [X6] ↵	Increase the total pixels by one on the current input.
Decrement value	[Esc] - TPIX ←	Tpix [X1] * [X6] ↵	Decrease the total pixels by one on the current input.
View	[Esc] TPIX ←	[X6] ↵	View the total pixel setting on the current input.

NOTES:

[X1] = Input selection

1 = configurable VGA
 2 = HDMI or DVI input 1
 3 = HDMI or DVI input 2
 4 = HDMI or DVI input 3

[X3] = Horizontal or vertical start

0-255 (128 = default)

[X4] = Pixel phase

0-63 (31 = default)

[X6] = Total pixels

±512 of the default value

Command	ASCII Command (host to scaler)	Response (scaler to host)	Additional Description
Active pixels			
Specify a value	Esc X7 APIX ←	Apix X1 * X7 ↵	Set the active pixels to X7 on the current input.
Increment value	Esc +APIX ←	Apix X1 * X7 ↵	Increase the active pixels by one on the current input.
Decrement value	Esc -APIX ←	Apix X1 * X7 ↵	Decrease the active pixels by one on the current input.
View	Esc APIX ←	X7 ↵	View the active pixels on the current input.
Active lines			
Specify a value	Esc X8 ALIN ←	Alin X1 * X8 ↵	Set the active lines to X8 on the current input.
Increment value	Esc +ALIN ←	Alin X1 * X8 ↵	Increase the active lines by one on the current input.
Decrement value	Esc -ALIN ←	Alin X1 * X8 ↵	Decrease the active lines by one on the current input.
View	Esc ALIN ←	X8 ↵	View the active lines on the current input.
3:2, 2:2, 24:1 Film mode detect			
Auto	Esc X1 *1FILM ←	Film X1 * X9 ↵	Set film mode detection to automatic (default).
Off	Esc X1 *ØFILM ←	Film X1 * X9 ↵	Disable film mode detection.
View setting	Esc X1 FILM ←	X9 ↵	View the current film mode setting.
HDCP authorized setting (valid for HDMI inputs only, to allow or block HDCP input signals)			
Enable HDCP authorization	Esc E X1 *1HDCP ←	HdcpE X1 *1 ↵	Enable HDCP authorization.
Disable HDCP authorization	Esc E X1 *ØHDCP ←	HdcpE X1 *Ø ↵	Disable HDCP authorization.
Query HDCP authorization status	Esc E X1 HDCP ←	X44 ↵ HdcpE X1 * X44 ↵	View HDCP authorization setting. Verbose mode 2 and 3
HDCP status (valid for HDMI inputs and the DTP output only)			
Query input	Esc I X1 HDCP ←	X31 ↵ HdcpI X1 * X31 ↵	View the HDCP status on input X1 . Verbose mode 2 and 3
Query output	Esc O 1HDCP ←	X31 ↵ HdcpO1 * X31 ↵	View the HDCP status on the output. Verbose mode 2 and 3

NOTES:

- X1** = Input selection
 - 1 = configurable VGA
 - 2 = HDMI or DVI input 1
 - 3 = HDMI or DVI input 2
 - 4 = HDMI or DVI input 3
- X7** = Active pixels
 - ±512 of the default value
- X8** = Active lines
 - ±256 of the default value
- X9** = Enable or disable
 - Ø = off or disabled
 - 1 = on or enabled
- X31** = HDCP status
 - Ø = no sink or source device detected
 - 1 = sink or source detected with HDCP
 - 2 = sink or source detected but no HDCP is present
- X44** = HDMI input HDCP authorization status
 - Ø = block HDCP encryption
 - 1 = allow HDCP encryption (default)

Command	ASCII Command (host to scaler)	Response (scaler to host)	Additional Description
Picture Adjustment Commands			
Contrast			
Specify a value	Esc X14 CONT ←	Cont X1 * X14 ↵	Set the contrast for the current input.
Increment value	Esc +CONT ←	Cont X1 * X14 ↵	Increase the contrast setting by one.
Decrement value	Esc -CONT ←	Cont X1 * X14 ↵	Decrease the contrast setting by one.
View	Esc CONT ←	X14 ↵	View the contrast setting.
Brightness			
Specify a value	Esc X14 BRIT ←	Brit X1 * X14 ↵	Set the brightness on the current input.
Increment value	Esc +BRIT ←	Brit X1 * X14 ↵	Increase the brightness setting by one.
Decrement value	Esc -BRIT ←	Brit X1 * X14 ↵	Decrease the brightness setting by one.
View	Esc BRIT ←	X14 ↵	View the brightness setting.
Detail filter			
Specify a value	Esc X14 HDET ←	Hdet X1 * X14 ↵	Set the detail filter for the current input.
Increment value	Esc +HDET ←	Hdet X1 * X14 ↵	Increase the detail setting by one.
Decrement value	Esc -HDET ←	Hdet X1 * X14 ↵	Decrease the detail setting by one.
View	Esc HDET ←	X14 ↵	View the detail filter setting.
Color (NTSC, PAL, and SECAM inputs only)			
Specify a value	Esc X14 COLR ←	Colr X1 * X14 ↵	Set the color level on the current input.
Increment value	Esc +COLR ←	Colr X1 * X14 ↵	Increase the color level setting by one.
Decrement value	Esc -COLR ←	Colr X1 * X14 ↵	Decrease the color level setting by one.
View	Esc COLR ←	X14 ↵	View the color level setting.
Tint (NTSC inputs only)			
Specify a value	Esc X14 TINT ←	Tint X1 * X14 ↵	Set the tint on the current input.
Increment value	Esc +TINT ←	Tint X1 * X14 ↵	Increase the tint setting by one.
Decrement value	Esc -TINT ←	Tint X1 * X14 ↵	Decrease the tint setting by one.
View	Esc TINT ←	X14 ↵	View the tint setting.
Auto Memories			
Enable	Esc X1 * 1 AMEM ←	Amem X1 * 1 ↵	Enable auto memory on input X1 .
Disable	Esc X1 * 0 AMEM ←	Amem X1 * 0 ↵	Disable auto memory on input X1 .
View	Esc X1 AMEM ←	X9 ↵	View the auto memories status.

NOTES:

X1 = Input selection

X9 = Enable or disable

X14 = Picture adjustment

- 1 = configurable VGA
- 2 = HDMI or DVI input 1
- 3 = HDMI or DVI input 2
- 4 = HDMI or DVI input 3
- 0 = off or disabled
- 1 = on or enabled
- 0-127 (64 = default)

Command	ASCII Command (host to scaler)	Response (scaler to host)	Additional Description
Horizontal shift (image)			
Specify a value	Esc X15 HCTR ←	Hctr X15 ↵	Set the horizontal position to X15 .
Increment value	Esc +HCTR ←	Hctr X15 ↵	Increase the horizontal position setting by one.
Decrement value	Esc -HCTR ←	Hctr X15 ↵	Decrease the horizontal position setting by one.
View	Esc HCTR ←	X15 ↵	View the horizontal position setting.
Vertical shift (image)			
Specify a value	Esc X16 VCTR ←	Vctr X16 ↵	Set the vertical position to X16 .
Increment value	Esc +VCTR ←	Vctr X16 ↵	Increase the vertical position setting by one.
Decrement value	Esc -VCTR ←	Vctr X16 ↵	Decrease the vertical position setting by one.
View	Esc VCTR ←	X16 ↵	View the vertical position setting.
Horizontal size (image)			
Specify a value	Esc X17 HSIZ ←	Hsiz X17 ↵	Set the horizontal size to X17 .
Increment value	Esc +HSIZ ←	Hsiz X17 ↵	Increase the horizontal size setting by one.
Decrement value	Esc -HSIZ ←	Hsiz X17 ↵	Decrease the horizontal size setting by one.
View	Esc HSIZ ←	X17 ↵	View the horizontal size setting.
Vertical size (image)			
Specify a value	Esc X18 VSIZ ←	Vsiz X18 ↵	Set the vertical size to X18 .
Increment value	Esc +VSIZ ←	Vsiz X18 ↵	Increase the vertical size setting by one.
Decrement value	Esc -VSIZ ←	Vsiz X18 ↵	Decrease the vertical size setting by one.
View	Esc VSIZ ←	X18 ↵	View the vertical size setting.
Compound image position and size			
Specify a value	Esc X15 * X16 * X17 * X18 XIMG ←	Ximg X15 * X16 * X17 * X18 ↵	Set the horizontal and vertical positions and sizes.
View	Esc XIMG ←	X15 * X16 * X17 * X18 ↵	View all position and size settings.
NOTES:			
X15 = Horizontal position		±2048	
X16 = Vertical position		±1200	
X17 = Horizontal size		10 - 4096	
X18 = Vertical size		10 - 2400	

Command	ASCII Command (host to scaler)	Response (scaler to host)	Additional Description		
Preset Commands					
User presets					
Recall preset	1 * X20 .	1Rpr X20 ↵	Recall user preset X20 .		
Save preset	1 * X20 ,	1Spr X20 ↵	Save the current picture controls.		
Delete preset	Esc X1 * X20 PRST ←	PrstX1 * X20 ↵	Clear user preset X20 .		
User preset name					
Write name	Esc 1 * X20 , X13 PNAM ←	Pnam1 * X20 , X13 ↵	Set user preset X20 name to X13 .		
View name	Esc 1 * X20 PNAM ←	X13 ↵	View the name of user preset X20 .		
NOTE: To clear a user preset name, enter a single space character for X13 . This resets the user preset name to the default value, "[User Preset XX]." This is valid only for existing presets.					
Input presets					
Recall preset	2 * X21 .	2Rpr X21 ↵	Recall input preset X21 .		
Save preset	2 * X21 ,	2Spr X21 ↵	See the table below for settings saved on input presets.		
Delete preset	Esc X2 * X21 PRST ←	PrstX2 * X21 ↵	Clear input preset X21 .		
Input preset name					
Write name	Esc 2 * X21 , X13 PNAM ←	Pnam2 * X21 , X13 ↵	Set input preset X21 name to X13 .		
View name	Esc 2 * X21 PNAM ←	X13 ↵	View the name of user preset X21 .		
NOTE: To clear an input preset name, enter a single space character for X13 . This resets the input preset name to the default value, "[Input Preset XXX]." This is valid only for existing presets.					
Saved Settings for User Presets		Saved Settings for Input Presets			
Color	Detail	Input Type	Contrast	V Start	Image H/V Position
Tint	Preset Name	Preset Name	Brightness	H Active	Image H/V Size
Contrast	Image H/V Position	Audio Gain/Attenuation	Detail	V Active	
Brightness	Image H/V Size	Color	Total Pixels	Phase	
		Tint	H Start	Film Mode	
NOTES:					
X13 = Text label	Up to 16 characters but cannot contain the following: \ / : * ? < > "				
X20 = User presets	1 - 16				
X21 = Input presets	1 - 16				

Command	ASCII Command (host to scaler)	Response (scaler to host)	Additional Description
Output Configuration Commands			
TMDs output format			
Set format	[Esc] [X34] VTPO ←	Vtpo [X34] ↵	Set the color space and format of the output to [X34] .
View setting	[Esc] VTPO ←	[X34] ↵ Vtpo [X34] ↵	View the color space and format setting. Verbose mode 2 and 3
View auto output format	[Esc] 1*VTPO ←	[X34] ↵	View the Auto output color space.
Power Save mode			
Power Save off	[Esc] ØPSAV ←	PsavØ ↵	Operate at full power.
Power Save on	[Esc] 1PSAV ←	Psav1 ↵	Operate in a low power state. There is no video output or DTP communication.
NOTE: It may take some time for DTP communication to resume after Power Save mode is turned off.			
View setting	[Esc] PSAV ←	[X42] ↵	View the Power Save mode.
Screen saver			
Set mode	[Esc] M [X28] SSAV ←	SsavM [X28] ↵	Set the color of the screen saver to [X28] .
View mode	[Esc] MSSAV ←	[X28] ↵ SsavM [X28] ↵	View the color of the screen saver. Verbose mode 2 and 3
Set time-out duration	[Esc] T [X22] SSAV ←	SsavT [X22] ↵	Set the time-out duration to [X22] .
View time-out duration	[Esc] TSSAV ←	[X22] ↵ SsavT [X22] ↵	View the time-out duration. Verbose mode 2 and 3
View screen saver status	[Esc] SSSAV ←	[X43] ↵ SsavS [X43] ↵	View the screen saver status. Verbose mode 2 and 3

NOTES:

[X22] = Output sync timeout

Ø = OSD is never displayed, output sync is instantly disabled with no active input
1 - 5ØØ (in 1 second increments)
5Ø1 = output sync never times out

[X28] = Screen saver mode

1 = black output (default)
2 = blue output

[X34] = HDMI output format

Ø = auto (default)
1 = DVI RGB 444
2 = HDMI RGB "Full"
3 = HDMI RGB "Limited"
4 = HDMI YUV 444 "Full"
5 = HDMI YUV 444 "Limited"
6 = HDMI YUV 422 "Full"
7 = HDMI YUV 422 "Limited"

[X42] = Power Save mode

Ø = full power mode (default)
1 = low power state

[X43] = Screen saver status

Ø = active input detected, timer not running
1 = no active input, timer running, output sync enabled
2 = no active input, timer expired, output sync disabled

Command	ASCII Command (host to scaler)	Response (scaler to host)	Additional Description
Video mute (defaults to unmuted after a power cycle)			
Mute video to black	1B	Vmt1 ←↵	Mute the video and display a black screen.
Mute output sync/video	2B	Vmt2 ←↵	Mute the video and sync on all outputs.
Unmute output	ØB	VmtØ ←↵	Display the selected input.
View mute status on all outputs	B	[X29] ←↵ Vmt [X29] ←↵	View the video mute setting. Verbose mode 2 and 3
Output scaler rate			
Set output rate	[Esc] [X49] RATE ←	Rate [X49] ←↵	Set the output resolution and rate to [X49].
View output rate	[Esc] RATE ←	[X49] ←↵	View the selected output rate.
NOTES:			
[X29] = Video mute on all outputs		Ø = unmute 1 = mute to black 2 = mute all output sync and video	
[X49] = Output rate		See the [X49] definition on page 34.	

Command	ASCII Command (host to scaler)	Response (scaler to host)	Additional Description
Audio Configuration Commands			
Output audio mute			
Enable global audio mute	1Z	Amt1 ←	Enables audio mute on all outputs.
Disable global audio mute	ØZ	AmtØ ←	Disable audio mute on all outputs.
Set discrete audio mute	[X48]*[X9]Z	Amt[X48]*[X9] ←	Set audio mute on output [X48].
View output audio mute	Z	[X9]•[X9] ←	View the audio mute status on the analog and digital audio output.
		Amt[X9]•[X9] ←	Verbose mode 2 and 3

Audio input format

NOTE: For audio input format details, see [Audio Configuration page](#) on page 70.

Set audio input format [Esc] I [X1]*[X35]AFMT ← AfmtI [X1]*[X35] ← Set the audio format of input [X1] to [X35].

NOTES:

- For input 1, [X35] can only be set to Ø, 1, and 2. Attempting to set this input to a digital format returns an E14 error message.
- For inputs 2-4, digital auto modes ([X35] = 5, 6, 7, and 8) detect and use embedded digital audio when present or will use the analog audio input when digital audio is not detected.

View audio input format [Esc] I [X1]AFMT ← [X35] ← View the audio input format of input [X1].

Audio gain and attenuation (analog inputs only)

Set gain or attenuation	[X38]G	Aud[X38] ←	Set the audio input gain to [X38].
Increment gain or attenuation	+G	Aud[X38] ←	Increase the audio input gain by 1 dB.
Decrement gain or attenuation	-G	Aud[X38] ←	Decrease the audio input gain by 1 dB.
View audio gain level	G	[X38] ←	View the audio level of the current input.

NOTES:

[X1] = Input selection

1 = configurable VGA
2 = HDMI or DVI input 1
3 = HDMI or DVI input 2
4 = HDMI or DVI input 3

[X9] = Enable or disable

Ø = off or disabled
1 = on or enabled

[X35] = Audio input format

Ø = none (input muted)
1 = analog 1 (TRS) (default for input 1)
2 = analog 2 (captive screw)
3 = LPCM-2Ch digital (default for inputs 2-4)
4 = Multi-Ch digital
5 = LPCM-2Ch digital auto (analog 1)
6 = Multi-Ch digital auto (analog 1)
7 = LPCM-2Ch digital auto (analog 2)
8 = Multi-Ch digital auto (analog 2)

[X38] = Audio input gain

-18 to +24 in dB (Ø = default)

[X48] = Audio output mute

1 = local 5-pole captive and remote 5-pole remote (DTP) captive analog audio output
2 = embedded HDMI audio

Command	ASCII Command (host to scaler)	Response (scaler to host)	Additional Description
Volume			
Set volume	<code>[X36]V</code>	<code>Vo1 [X36]↵</code>	Set the volume.
Increment the volume	<code>+V</code>	<code>Vo1 [X36]↵</code>	Increase the volume by 1 dB.
Decrement the volume	<code>-V</code>	<code>Vo1 [X36]↵</code>	Decrease the volume by 1 dB.
View the volume setting	<code>V</code>	<code>[X36]↵</code> <code>Vo1 [X36]↵</code>	View the volume level. Verbose mode 2 and 3
Audio output format (analog outputs only)			
Set audio output format	<code>[Esc]01*[X37]AFMT↵</code>	<code>Afmt01*[X37]↵</code>	Set the audio output format to <code>[X37]</code> .
View audio output format	<code>[Esc]0AFMT↵</code>	<code>[X37]↵</code> <code>Afmt01*[X37]↵</code>	View the audio output format. Verbose mode 2 and 3
Advanced Configuration Commands			
Test pattern			
Set pattern	<code>[Esc][X19]TEST↵</code>	<code>Test [X19]↵</code>	Set test pattern <code>[X19]</code> .
View test pattern	<code>[Esc]TEST↵</code>	<code>[X19]↵</code>	View the current test pattern.
Freeze			
Enable	<code>1F</code>	<code>Frz1↵</code>	Freeze the current input.
Disable	<code>ØF</code>	<code>FrzØ↵</code>	Unfreeze the current input.
View freeze status	<code>F</code>	<code>[X9]↵</code>	View the freeze setting.
NOTES:			
<code>[X9]</code> = Enable or disable		<code>Ø</code> = off or disabled <code>1</code> = on or enabled	
<code>[X19]</code> = Test patterns		<code>Ø</code> = none (default) <code>1</code> = crop <code>2</code> = alternating pixels <code>3</code> = crosshatch <code>4</code> = color bars <code>5</code> = grayscale <code>6</code> = blue mode <code>7</code> = audio test pattern (pink noise)	
<code>[X36]</code> = Audio volume		<code>-1ØØ</code> to <code>Ø</code> in 1 dB steps where <code>Ø</code> = 0 dB and <code>-1ØØ</code> = -100 dB (<code>-1Ø</code> = default)	
<code>[X37]</code> = Audio output format		<code>1</code> = dual mono <code>2</code> = stereo (default)	

Command	ASCII Command (host to scaler)	Response (scaler to host)	Additional Description
Input aspect ratio (per input)			
Set for fill	Esc X1 *1ASPR ←	Aspr X1 *1 ↵	Fill the entire output.
Set to follow	Esc X1 *2ASPR ←	Aspr X1 *2 ↵	Maintain the input aspect ratio.
View aspect setting	Esc X1 ASPR ←	X27 ↵	View the aspect ratio setting.
Front Panel Lockout modes (Executive mode)			
Enable mode 1	1X	Exe1 ↵	Lock the entire front panel.
Enable mode 2	2X	Exe2 ↵	Limit front panel control to input switching and Auto-Image.
Disable	ØX	ExeØ ↵	Unlock the front panel.
View status	X	X23 ↵	View the lock mode.
Overscan mode (applies only to SMPTE input resolutions)			
Set value	Esc X2 * X26 OSCN ←	Oscn X2 * X26 ↵	Set the overscan value to X26 .
View status	Esc X2 OSCN ←	X26 ↵	View the overscan setting.
Video signal presence			
View video signal presence status	Esc ØLS ←	X41 X41 X41 X41 ↵	View video signal presence for all inputs.
		InØØ • X41 X41 X41 X41 ↵	Verbose modes 2 and 3

NOTES:

- | | |
|------------------------------------|--|
| X1 = Input selection | 1 = configurable VGA
2 = HDMI or DVI input 1
3 = HDMI or DVI input 2
4 = HDMI or DVI input 3 |
| X2 = Input video format | 1 = RGB
2 = YUV
3 = S-video
4 = Composite
5 = HDMI |
| X9 = Enable or disable | Ø = off or disabled
1 = on or enabled |
| X23 = Executive mode status | Ø = off or disabled (default)
1 = mode 1 (complete front panel lockout)
2 = mode 2 (input selection and Auto-Image only) |
| X26 = Overscan | Ø = 0.0% (default for RGB and HDMI)
1 = 2.5% (default for YUV, S-Video, and CV)
2 = 5.0% |
| X27 = Aspect ratio setting | 1 = fill (default)
2 = follow |
| X41 = Video signal status | Ø = video/HDMI signal not detected
1 = video/HDMI signal detected |

Command	ASCII Command (host to scaler)	Response (scaler to host)	Additional Description
Auto switch mode			
Disable auto switch mode	[Esc] ØAUSW ←	AuswØ ←	Manual input switching only.
Prioritize highest active input	[Esc] 1AUSW ←	Ausw1 ←	Automatically switches to the highest numbered active input.
Prioritize lowest active input	[Esc] 2AUSW ←	Ausw2 ←	Automatically switches to the lowest numbered active input.
View auto switch mode	[Esc] AUSW ←	[X35] ←	View the current auto switch mode.
Video switch effect			
Cut	[Esc] ØSWEF ←	Swe fØ ←	Set the switch effect to cut.
Fade through black	[Esc] 1SWEF ←	Swe f1 ←	Set the switch effect to fade through black (default).
View setting	[Esc] SWEF ←	[X32] ←	View the switch effect setting.
HDCP mode			
Set HDCP mode	[Esc] S [X33] HDCP ←	HdcpS [X33] ←	Set HDCP authentication and encryption settings.
View HDCP mode	[Esc] SHDCP ←	[X33] ←	View the HDCP mode setting.
HDCP notification (displayed on non-HDCP displays with HDCP input selected)			
Enable notification	[Esc] N1HDCP ←	HdcpN1 ←	Display a green screen.
Disable notification	[Esc] NØHDCP ←	HdcpNØ ←	Mute output to black.
Query notification	[Esc] NHDCP ←	[X9] ←	View the HDCP notification setting.
AV mute (from contact and tally pins)			
Configure AV mute	[Esc] [X46] * [X47] MUTM ←	Mutm [X46] * [X47] ←	Configure the operation of Contact In and Tally Out ports.
View AV mute setting	[Esc] MUTM ←	[X46] * [X47] ←	View the current status of Contact In and Tally Out port configuration.

NOTES:

[X9] = Enable or disable	Ø = off or disabled 1 = on or enabled
[X32] = Video switching effect	Ø = cut 1 = fade through black (default)
[X33] = HDCP mode	Ø = HDMI outputs are always authenticated, but only encrypted when required. 1 = HDMI outputs are always authenticated and encrypted 2 = HDMI outputs are always authenticated, but only encrypted when required, with continuous DVI trials 3 = HDMI outputs are always authenticated and encrypted, with continuous DVI trials
[X35] = Auto switch mode	Ø = disable (default) 1 = gives priority to the highest numbered active input 2 = gives priority to the lowest numbered active input
[X46] = AV mute mode	Ø = normal operation (default) 1 = perform video and audio mute 2 = perform video sync and audio mute
[X47] = Mute LED mode	Ø = always on (default) 1 = off when muted 2 = blink when muted

Command	ASCII Command (host to scaler)	Response (scaler to host)	Additional Description
On-Screen Menu Configuration Commands			
Front control panel emulation			
Toggle menu	[Esc] MMENU←	Menu*M↵	Toggle the OSD menu on or off.
Enter menu	[Esc] AMENU←	Menu*A↵	Enter OSD menu.
Exit menu	[Esc] XMENU←	Menu*X↵	Exit OSD menu.
Enter	[Esc] EMENU←	Menu*E↵	Emulate the Enter button.
Up arrow	[Esc] UMENU←	Menu*U↵	Emulate the Up button.
Down arrow	[Esc] DMENU←	Menu*D↵	Emulate the Down button.
Left arrow	[Esc] LMENU←	Menu*L↵	Emulate the Left button.
Right arrow	[Esc] RMENU←	Menu*R↵	Emulate the Right button.
View OSD menu status	[Esc] MENU←	[X9] ↵ Menu [X9] ↵	Show the status of the OSD menu. Verbose mode 2 and 3
Device Commands			
Reset			
Reset all device settings to factory default	[Esc] ZXXX←	Zpx↵	Reset all device settings the factory defaults.
Verbose mode			
Set verbose mode	[Esc] [X24] CV←	Vrb [X24] ↵	Enable or disable verbose mode and tagged responses, where additional information is provided in response to a query.
View verbose mode setting	[Esc] CV←	[X24] ↵	View the verbose mode setting.
Unit name			
Set unit name	[Esc] [X25] CN←	Ipn● [X25] ↵	Set the device name to [X25] .
NOTE: Characters must be from the alphabet (A-Z), digits (0-9), or the minus or hyphen sign (-). Lowercase and uppercase letters are interchangeable. The first character must be an alpha character. The last character cannot be a minus sign or hyphen.			
View unit name	[Esc] CN←	[X25] ↵	View the device name.
Reset unit name	[Esc] ●CN←	Ipn●IN1604●DTP↵ or Ipn●IN1604●HD↵	Reset the device name to the factory default. The device name depends on the device model.
NOTES:			
[X9] = Enable or disable		∅ = off or disabled 1 = on or enabled	
[X24] = Verbose mode		∅ = clear or none 1 = verbose mode (default for RS-232 and USB connections) 2 = tagged responses for queries 3 = verbose mode and tagged queries	
[X25] = Device name		text label up to 24 characters	

Command	ASCII Command (host to scaler)	Response (scaler to host)	Additional Description
Information request			
General Information	I	Vid X1 • Typ X2 • Std X10 • Amt X9 • ... Blk X29 • Hrt X12 • Vrt X12 ↵	
Query firmware version	Q	x.xx ↵	View firmware version.
Query full firmware version	*Q	x.xx.xxxx ↵	View full firmware version.
Query boot loader version, factory firmware version, and current firmware version	ØQ	x.xx-x.xx.xxxx - x.xx.xxxx ↵	View boot loader version, factory firmware, and current user firmware.
Query part number	N	<part number> ↵	View the part number.
View internal temperature	Esc 2ØSTAT ↵	X11 ↵ 2ØStat • X11 ↵	View the temperature in degrees Celsius. Verbose mode 2 and 3
View device description	2i	SCALING • ... PRESENTATION • ... SWITCHER ↵	View the unit description.
View TP protocol	Esc 01HDBT ↵	X45 ↵ Hdbt01 * X45 ↵	View the current twisted pair output format for the output. Verbose mode 2 and 3
<p>NOTE: This is a read-only command for the IN1604 DTP only. To adjust the TP protocol, use the rear panel switch (see TP output connector and TP output switch (IN1604 DTP only) on page 8).</p>			

NOTES:

- | | |
|--|---|
| X1 = Input selection | 1 = configurable VGA
2 = HDMI or DVI input 1
3 = HDMI or DVI input 2
4 = HDMI or DVI input 3 |
| X2 = Input video format | 1 = RGB
2 = YUV
3 = S-video
4 = Composite
5 = HDMI |
| X9 = Enable or disable | Ø = off or disabled
1 = on or enabled |
| X10 = Input standard | Ø = no signal detected on the current input
1 = NTSC 3.85
2 = PAL
3 = NTSC 4.43
4 = SECAM
- = not applicable |
| X11 = Internal temperature | In degrees Celsius |
| X12 = Horizontal and vertical frequency | |
| X29 = Video mute on all outputs | Ø = all outputs are unmuted
1 = at least one output is muted
2 = at least one output is muted and sync is disabled |
| X45 = TP output format | Ø = DTP format (default)
1 = HDBaseT format |

Configuration Software

The Extron Product Configuration Software (PCS) offers another way to control the scalars via USB connection in addition to the SIS commands.

This section describes the software installation and communication (see the *IN1604 Series Product Configuration Software* help file for additional control information). Topics in this section include:

- [Software Installation](#)
- [Software Connection](#)
- [Software Overview](#)
- [AV Controls Panel](#)
- [Configuration Pages](#)

The graphical interface includes the same functions as those on the device front panel with additional features that are available only through the software.

The control software is compatible with Microsoft Windows operating systems. The software program is available on the Extron [website](#).

Software Installation

The screenshot shows the Extron Electronics website's Download Center. The browser address bar displays www.extron.com/download/index.aspx?s=tab06. The website header includes the Extron logo, the tagline "INTERFACING, SWITCHING AND CONTROL", and contact information: "S3 Support Hotline 800.633.9876". A navigation menu at the top includes "Products", "Training", "Markets", "Tech Library", "Company", and "Download" (highlighted with a red circle and the number 1). A search bar is located to the right of the navigation menu. The main content area is titled "Download" and features a sidebar on the left with a list of software categories, including "Software", "Control System Drivers", "Firmware", "HID Modules", and "Resources". The "Software" category is expanded, showing "PCS" (highlighted with a red circle and the number 2) and other software like "Dante Controller", "DSP Configurator", "Global Configurator Professional", "GUI Configurator", "IP Intercom HelpDesk", "TouchLink for iPad", and "XTP System Configuration Software". The main content area displays a "Download" section with a table of software downloads, including "SMP-351-Demo Room", "SMP-351-Engineering Conf Room", "SMP-351-Classroom", and "SMP-351-Marketing Conf Room". Below the table is a "Streaming Content Manager" section with a "Learn more" and "Download" button. To the right of the table are two promotional boxes for "XTP System Configuration Software" and "Global Configurator Professional".

Figure 22. PCS Download from the Extron Website

1. On the Extron website, select the **Download** tab (see figure 22, ❶).
2. From the left sidebar, click the **PCS** link (❷).
3. Click the **Download** button.
4. Submit any required information to start the download. Note where the file is saved.
5. Open the executable (.exe) file from the save location.
6. Follow the instructions that appear on the screen. By default, the installation creates a directory (if one does not exist) in the Program Files or Program Files (x86) folder.

Software Connection

Open the Product Configuration Software program from the **Start** menu or desktop shortcut. The Extron Product Configuration Software window opens with the **Start-up** screen. Connect to the scaler using the **Device Discovery** panel.

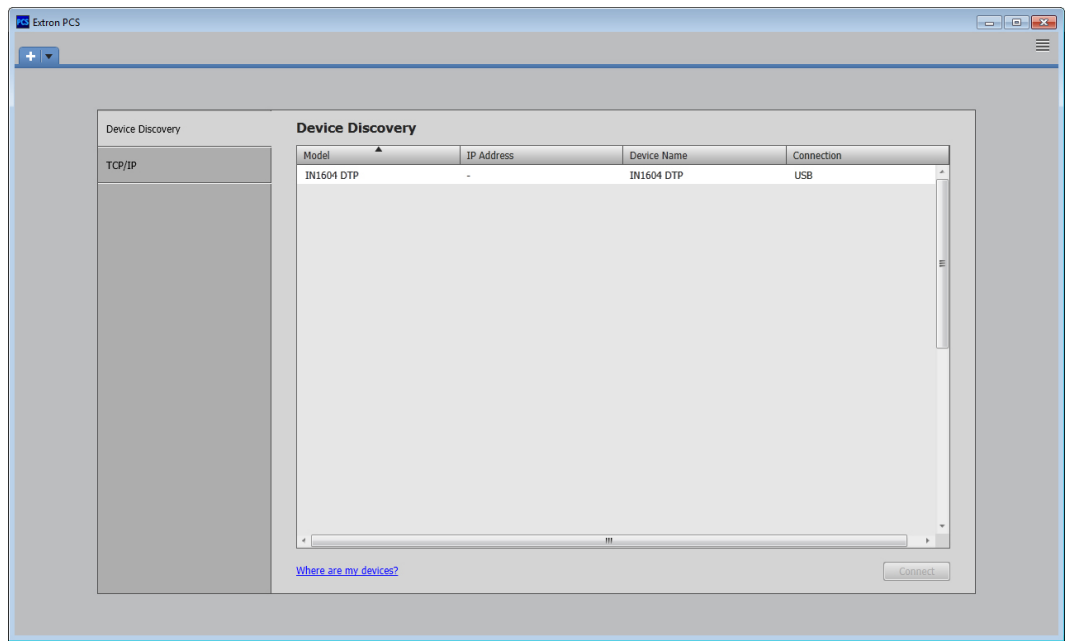

Figure 23. Start-up Window (IN1604 DTP Connected)

NOTE: PCS versions prior to 2.0 do not have the Device Discovery feature. If possible, update the PCS version from the Extron [website](#). If that is not possible, connect to the scaler by choosing the connection method and submitting the required information in the current PCS version.

Offline device configuration is not supported with the IN1604 DTP and IN1604 HD scalers, but the configuration screens and panels can still be viewed.

Device Discovery Panel

The **Device Discovery** panel displays accessible Extron devices connected directly to the PC using the software. Devices can be identified and sorted by model, IP address, device name, or connection method.

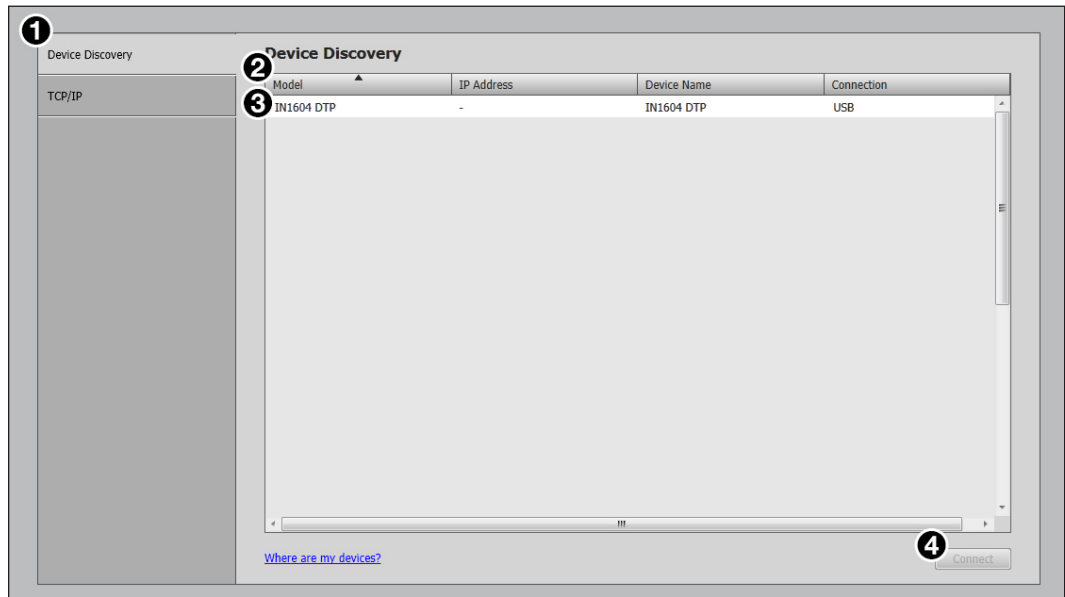

Figure 24. Device Discovery Panel

To sort the list of available devices:

1. Click the **Device Discovery** tab (see figure 24, **1**).
2. Click the desired column heading (**2**) to sort the category in ascending or descending order.

To connect to a device:

1. Click the **Device Discovery** tab (**1**).
2. Select the desired device (**3**).
3. Click the **Connect** button (**4**). A new device configuration tab opens.

Offline Device Preview

The configuration options for scalers can be viewed without connecting to a device, but the settings cannot be changed or saved.

To open a scaler device tab:

1. In the **Start-up** drop-down menu, select **New Configuration File**. The New Configuration File dialog box opens.

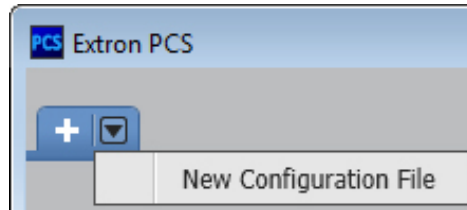

Figure 25. Start-up Drop-down Menu

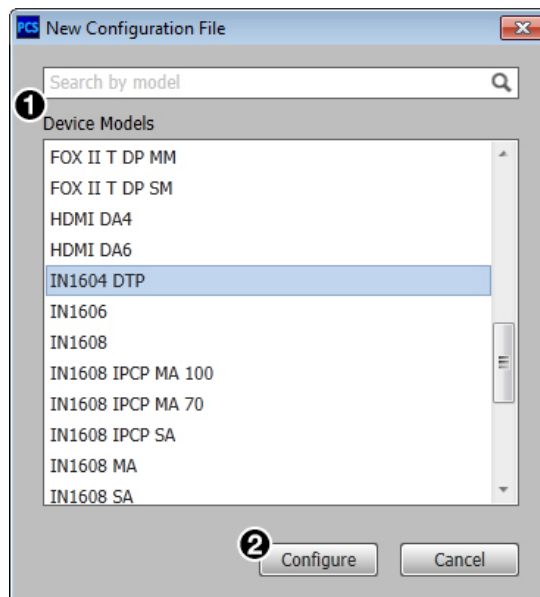

Figure 26. New Configuration File Dialog Box (IN1604 DTP Selected)

2. Select the desired device model from the Device Models list (see figure 26, ①).
3. Click the **Configure** button (see figure 26, ②). A new offline device configuration tab opens. An offline device is noted by the gray indicator (an online device has a green indicator) on the left of the device tab.

Software Overview

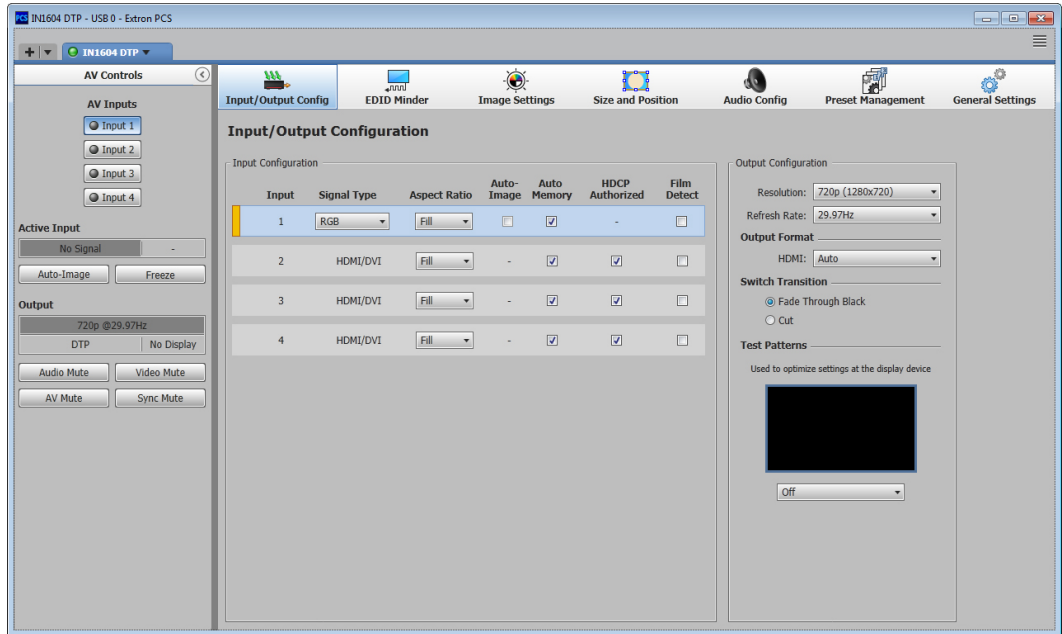

Figure 27. Online Device Tab (IN1604 DTP Shown)

Each device tab has a **Device** drop-down menu to the right of the device name for device-specific configuration options. The **Software** menu in the top right corner provides software configuration and information options for PCS and is available to all device modules.

Software Menu

The **Software** menu contains options to display device connection methods in the device tabs, re-enable confirmation dialogs, and view software information.

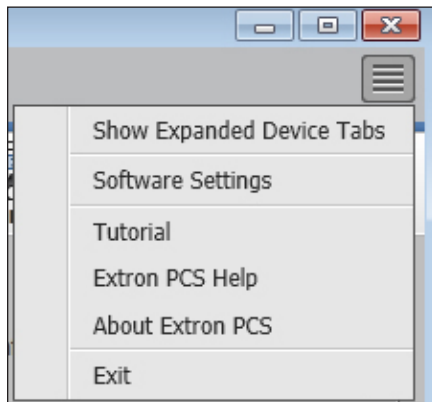

Figure 28. Software Menu

Show Expanded Device Tabs

This option contains a setting to display the device connection method in the **Device** tab. From the **Software** menu, select **Show Expanded Device Tabs**.



Figure 29. Expanded Device Tab (IN1604 DTP Connected through USB)

Software Settings

This option resets all disabled confirmation dialogs to the default settings.

1. From the **Software Menu**, select **Software Settings**. The **Software Settings** dialog box opens.

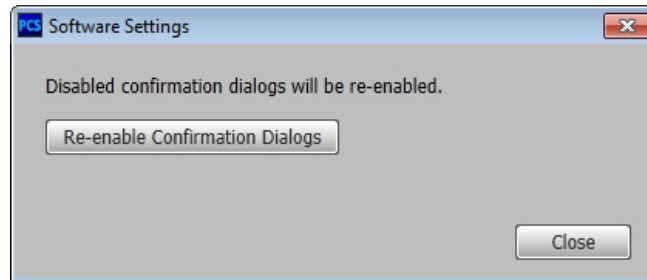

Figure 30. Software Settings Dialog Box

2. Click the **Re-enable Confirmation Dialogs** button. The dialog box closes and the reset is complete. Click the **Close** button to close the dialog box without re-enabling the confirmation dialogs.

Tutorial

This option displays a general overview of where to find features in the PCS framework.

1. From the **Software** menu, select **Tutorial**. The **Tutorial** dialog box opens.
2. Click the **I Get It!** button to close the dialog box.

Extron PCS Help

This options opens the PCS Help file for general PCS operations. For product-specific help files, see [Product help file](#) on page 58.

From the **Software** menu, select **Extron PCS Help**.

About Extron PCS

This option contains information about the current PCS version.

1. From the **Software** menu, select **About Extron PCS**. The **About - Extron PCS** dialog box opens.



Figure 31. About - Extron PCS Dialog Box

2. Click the **Details** button for more information.
3. Click the **OK** button to close the dialog box.

Exit

This option disconnects PCS from connected devices and closes the application.

1. From the **Software** menu, select **Exit**. If device tabs are open, the **Exit** dialog box opens.

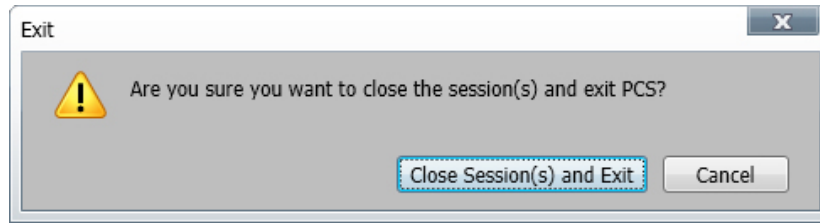

Figure 32. Exit Dialog Box

2. If necessary, click the **Close Session(s) and Exit** button to disconnect the software from connected devices, close all offline device tabs, and close the software. Click the **Cancel** button to leave the software open.

Device Menu

The **Device** drop-down menu contains options for disconnecting, changing hardware settings, resetting the device, saving and opening configuration settings, updating firmware, and viewing software information.

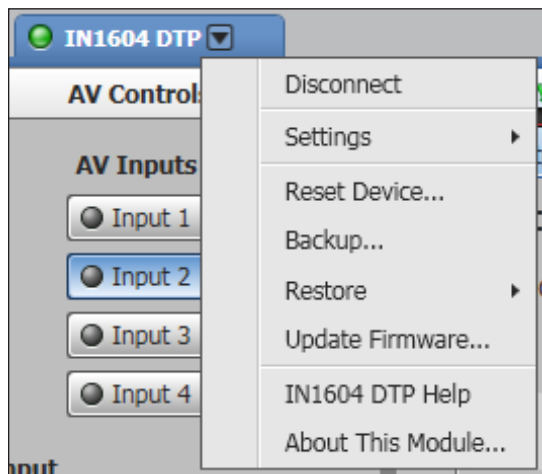

Figure 33. Device Menu

Disconnect

This option disconnects the PCS program from the connected device and closes the device tab.

From the **Device Menu**, select **Disconnect**.

Hardware Settings

This option opens a dialog box that displays unit information of the connected device.

From the **Device** drop-down menu, select **Settings > Hardware Settings....** The **Hardware Settings** dialog box opens.

Unit Information tab

The **Unit Information** tab displays basic information about the connected device.

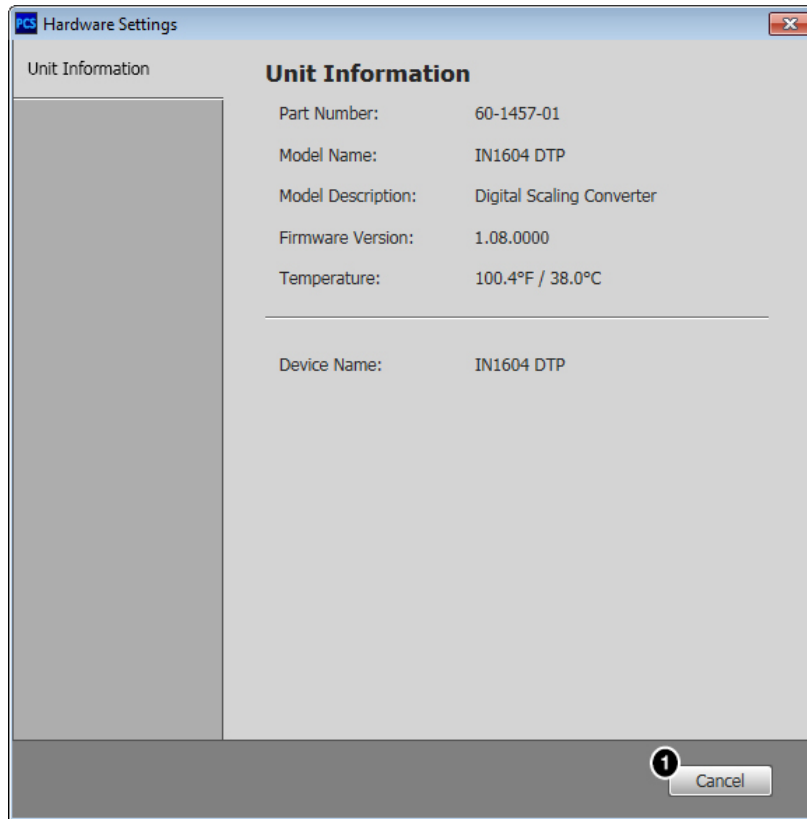

Figure 34. Unit Information Tab (IN1604 DTP Shown)

Click the **Cancel** button (1) to close the dialog box.

Reset Device

This option opens a dialog box to confirm the resetting of device settings.

From the **Device** drop-down menu, select **Reset Device...**. The **Reset Device** dialog box opens.

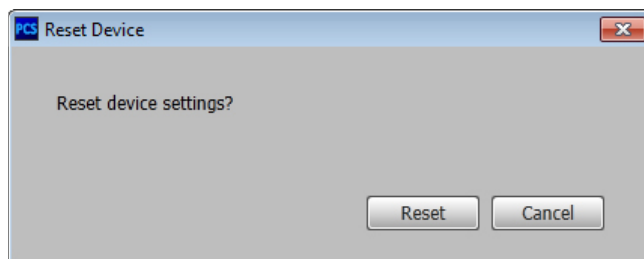

Figure 35. Reset Device Dialog Box

The reset changes all device settings to the factory defaults. It is the same as the

[Esc] ZXXX ← SIS command (see **Reset SIS commands** on page 47).

To reset the connected device, click the **Reset** button. To exit the **Reset Device** dialog box without making any changes, click the **Cancel** button.

Backup

The **Backup** option exports all audio, video, and communication settings of the connected device to the PC. This exported configuration can be saved as a backup, or be used to replicate settings from one device to other devices of the same model. When restoring a configuration, specific device settings can be selected.

To save the current configuration settings to an external file:

1. From the **Device** drop-down menu, click **Backup**. The Backup window opens.
2. Navigate to the desired save location on the PC and click the **Save** button. The window closes.

Restore

The Restore option restores a saved configuration to the connected device.

To restore a saved configuration settings file:

1. From the **Device** drop-down menu, select **Restore this Device...**. The Restore This Device dialog box opens.

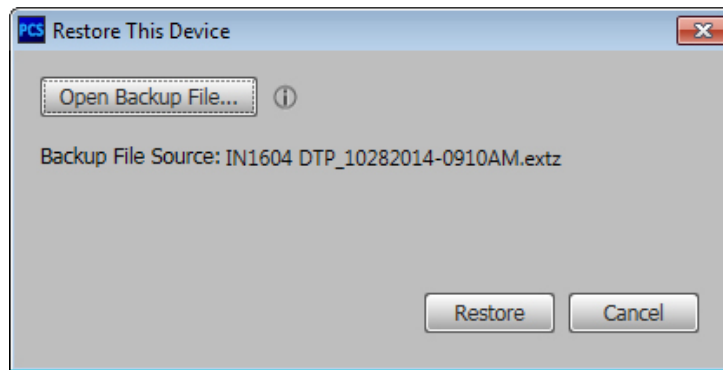
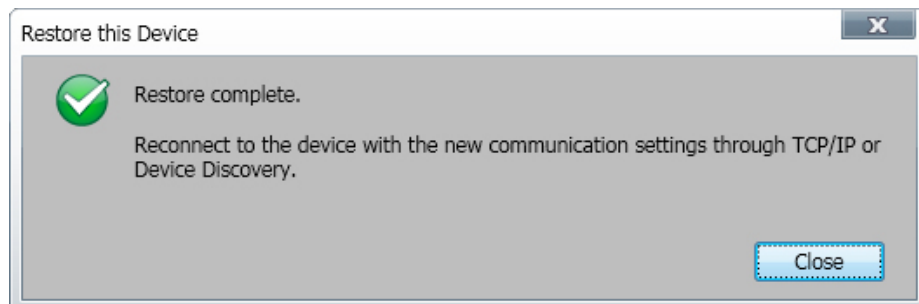

Figure 36. Restore This Device Dialog Box

2. Click the **Open Backup File...** button. The Open Backup File window opens.
3. Navigate to the location of the saved file on the PC.
4. Select the file and click the **Open** button. The Open Backup File window closes.

NOTE: Valid configuration files have a .extz file extension.

5. Click the **Restore** button to apply the configuration settings. A dialog box opens.



6. Click the **Close** button to close the Restore this Device dialog box.

Update Firmware

This option uploads firmware from the host device to the connected device.

NOTE: If necessary, download new firmware from the Extron website to the host device (see [Downloading Updated Firmware](#) on page 79).

1. From the **Device** drop-down menu, select **Update Firmware**. A dialog box opens to ask permission to disconnect from the device.
2. Click the **Continue** button to disconnect from the device and continue with the firmware update process. The **Update Firmware** dialog box opens.

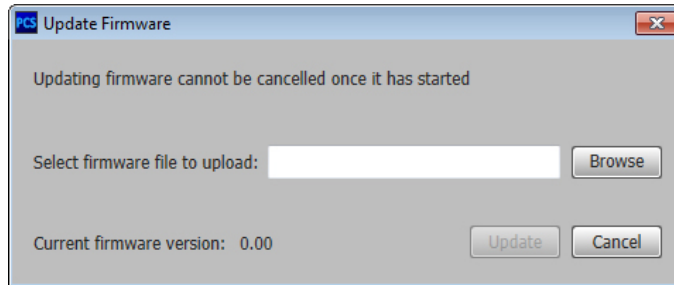

Figure 37. Update Firmware Dialog Box (Update)

3. Click the **Browse** button.
4. Navigate to the desired firmware file and select the device-specific firmware file. Valid firmware files have an .eff or .esf file extension.
5. Click the **Open** button.
6. In the **Update Firmware** dialog box, click the **Update** button.

Product help file

This option contains a link to the device help file.

From the **Device** drop-down menu, select **[Device] Help**. The help file opens in a separate window.

About This Module

This option contains the module part number and version number of the device tab in PCS.

1. From the **Device** drop-down menu, select **About This Module...**. The **About This Module** dialog box opens.

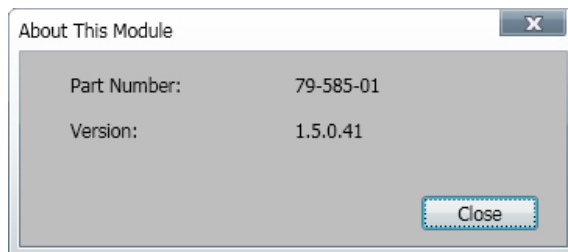

Figure 38. About This Module Dialog Box

2. Click the **Close** button to close the dialog box.

AV Controls Panel

The AV Controls panel is used to control AV settings such as input selection, one-time Auto-Image to an input, video and audio mute, and image freeze. The panel also displays input and output information.

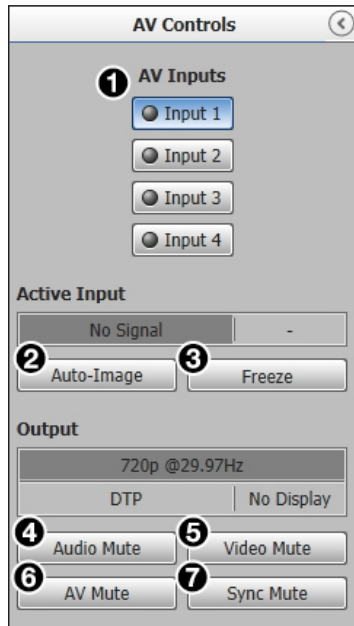

Figure 39. AV Controls Panel

AV Inputs Buttons

Click an input button from the AV Inputs panel (1) to select an input. As a new input is selected, the Active Input section displays information about the current input.

NOTE: The signal indicators on the AV input buttons display green when a signal is present on the corresponding input or gray when there is no signal present.

Auto-Image Button

Click the **Auto-Image** button (2) to start a one-time Auto-Image on the selected input.

Freeze Button

Click the **Freeze** button (3) to freeze the input. The button turns blue.

Mute Buttons

- Click the **Audio Mute** button (4) to globally mute only the audio. The button turns red when enabled.
- Click the **Video Mute** button (5) to mute only the video. The button turns red when enabled.
- Click the **AV Mute** button (6) to mute both the video and audio simultaneously. The button turns red along with the **Video Mute** and **Audio Mute** buttons when enabled.
- Click the **Sync Mute** button (7) to mute the video and sync. The button turns red along with the **Video Mute** button when enabled.

To unmute any signal, click the appropriate button. The button reverts to the default color, indicating the signal has been unmuted.

Configuration Pages

The configuration pages contain options for input and output configuration, EDID management, image settings, image size and position, audio configuration, preset management, and general settings.

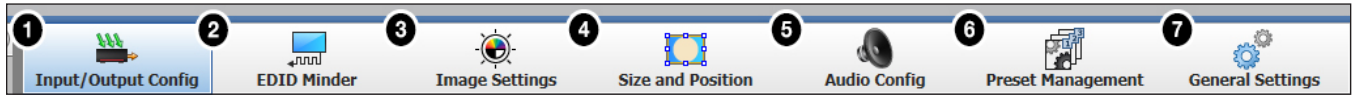
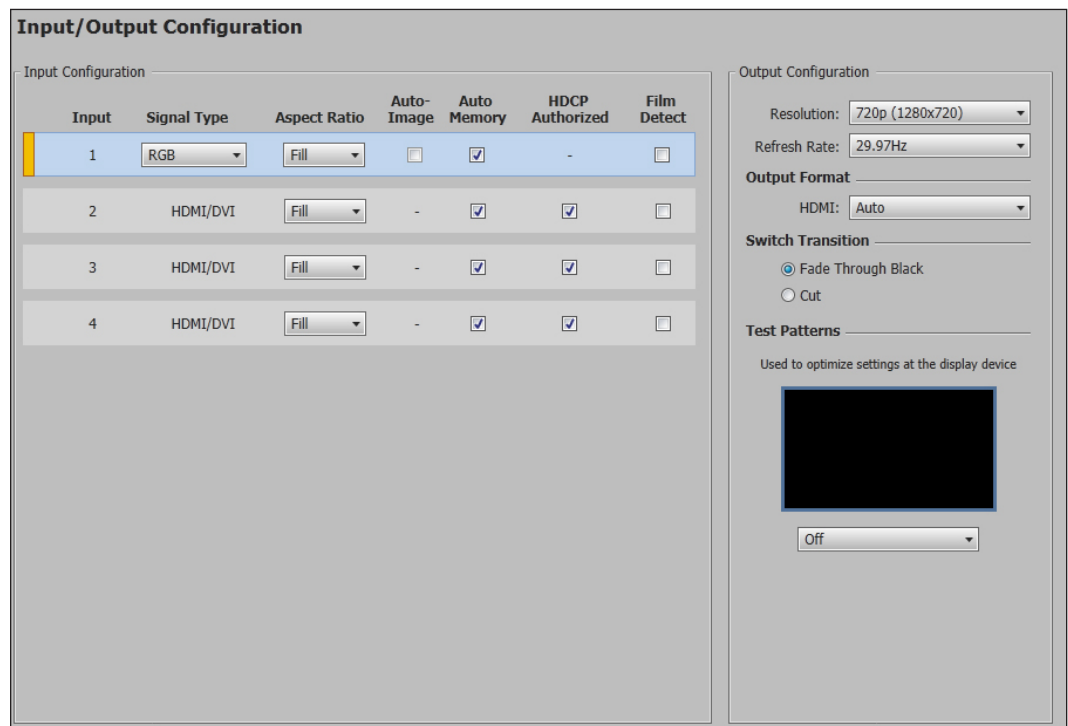

Figure 40. Global Navigation Bar

Input and Output Configuration Page

To open this page, click the **Input/Output Config** icon (1) on the Global Navigation Bar. It contains panels for individual input configuration, output configuration, switch transitions, and test pattern generation.



Input	Signal Type	Aspect Ratio	Auto-Image	Auto Memory	HDCP Authorized	Film Detect
1	RGB	Fill	<input type="checkbox"/>	<input checked="" type="checkbox"/>	-	<input type="checkbox"/>
2	HDMI/DVI	Fill	-	<input checked="" type="checkbox"/>	<input checked="" type="checkbox"/>	<input type="checkbox"/>
3	HDMI/DVI	Fill	-	<input checked="" type="checkbox"/>	<input checked="" type="checkbox"/>	<input type="checkbox"/>
4	HDMI/DVI	Fill	-	<input checked="" type="checkbox"/>	<input checked="" type="checkbox"/>	<input type="checkbox"/>

Output Configuration

Resolution: 720p (1280x720)

Refresh Rate: 29.97Hz

Output Format

HDMI: Auto

Switch Transition

Fade Through Black

Cut

Test Patterns

Used to optimize settings at the display device

Off

Figure 41. Input/Output Configuration Page

Input Configuration panel

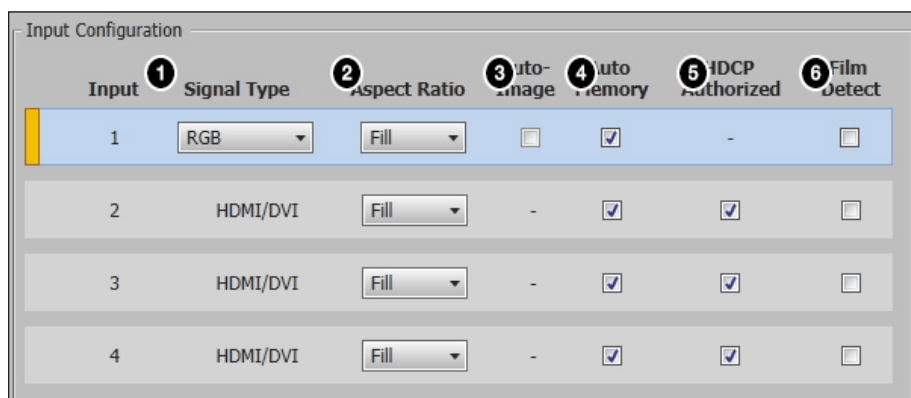

Figure 42. Input Configuration Panel

To configure an input, adjust the following:

1. For analog input 1, select the desired input signal type from the **Signal Type** drop-down menu (1). Available options include **RGB** (default), **YUV**, **S-Video**, and **Composite**. All other inputs have a signal type of **HDMI / DVI**.
2. From the **Aspect Ratio** drop-down menu (2), select one of the following:
 - **Fill** — Scales the input signal to fill the entire video output.
 - **Follow** — Follows the signal aspect ratio, with respect to the current output resolution setting. Black letter box or pillar box bars may be applied for aspect ratio compensation.
3. For analog input 1, select the **Auto-Image** check box (3) to enable an automatic Auto-Image to the input. When enabled, Auto-Image is applied whenever there is a change in the input sync. Auto-Image attempts to size and center the input signal based on the aspect ratio setting.

By default, the Auto-Image threshold is 25% brightness. An analog video signal greater than the threshold is considered active video. To change the threshold value, use SIS commands (see [Auto-Image threshold value](#) commands on page 35).

4. To enable the auto memory for an individual input, select the **Auto Memory** check box (4) of the desired input. Auto memory recalls input and image settings for signals that have previously been applied. When auto memory is disabled, the scaler treats every newly applied input as a new source.
5. To enable the HDCP Authorized feature for inputs 2-4, select the **HDCP Authorized** check box (5). This feature determines if a digital input will report as an HDCP authorized sink to a source.

NOTE: This option is not available for analog input 1.

For source devices that require encryption, enable HDCP Authorized. If HDCP Authorized is disabled for sources that require encryption (for example, a Blu-ray player), the output is muted or a warning message is displayed.

Some source devices may encrypt their output even if the source material does not require HDCP encryption, preventing content from being displayed on a non-HDCP compliant display. Disable HDCP Authorized to allow the output of the scaler to remain unencrypted.

6. To enable automatic 3:2 and 2:2 film pulldown detection for NTSC, PAL, SECAM, and 1080i input signals, select the **Film Detect** check box (6).

Output Configuration panel

The Output Configuration panel contains controls for output resolution and rate, format settings, switch transitions, and available test pattern selections.

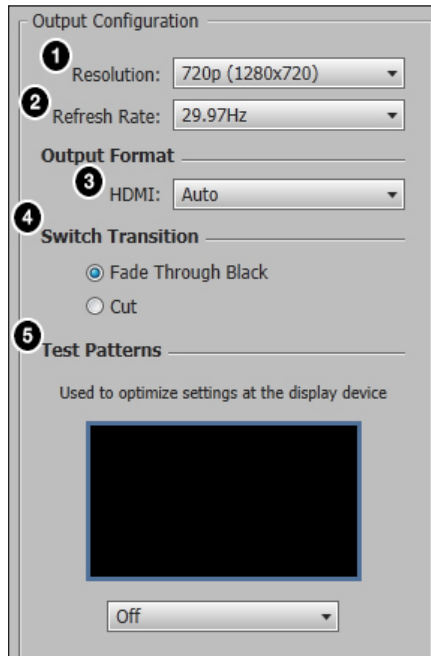

Figure 43. Output Configuration

To configure the output, perform the following:

1. From the **Resolution** drop-down menu (1), select the desired output resolution.
2. From the **Refresh Rate** drop-down menu (2), select the desired refresh rate.
3. From the **HDMI** drop-down menu (3), select the desired output format.
4. In the **Switch Transitions** panel (4), select one of the following radio buttons:
 - **Fade Through Black** — Fades video to a black screen before switching to the newly selected video.
 - **Cut** — Switches video directly to the newly selected input.
5. To aid display device setup and optimization, select a test pattern from the drop-down menu (5) in the **Test Patterns** panel.

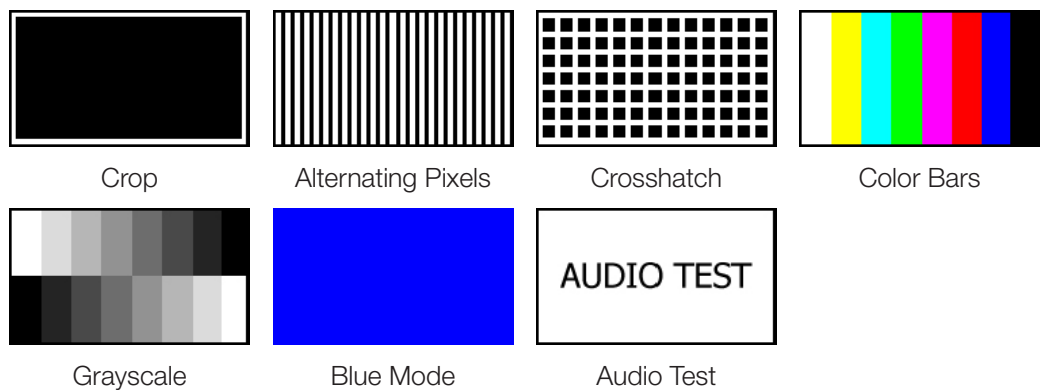

Figure 44. Available Test Patterns

NOTE: No input signal is needed when using a test pattern for display device setup.

EDID Minder Page

EDID Minder is an EDID management process that manages the EDID information between the scaler and one or more input sources. Click the **EDID Minder** icon (see **figure 40**, **2** on page 60) on the **Global Navigation Bar** to open the EDID Minder page.

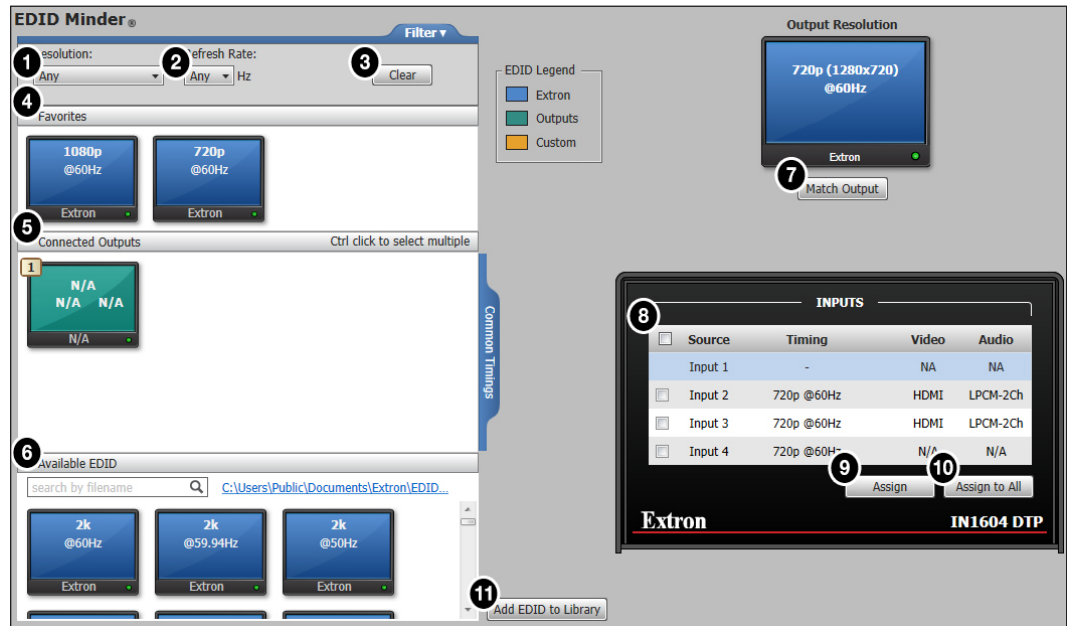

Figure 45. EDID Minder Page

The EDID properties currently assigned to each input are displayed in the table of inputs. The audio input format listed in an EDID is determined by the audio input format selected on the Audio Configuration page (unless a custom EDID is used).

Audio Input Format	Audio Capabilities Listed in EDID
None	No audio
Analog 1 or 2	No audio
LPCM-2Ch	2-channel LPCM audio
Multi-Ch	Multi-channel audio
LPCM-2Ch Auto (analog 1 or 2)	2-channel LPCM audio
Multi-Ch Auto (analog 1 or 2)	Multi-channel audio

EDID can be stored or imported as custom EDID files. Up to five EDID files can be stored on the scaler depending on the scaler model. Audio settings from custom EDID files take priority over current settings on the input.

NOTE: If an analog custom EDID file is assigned to a digital input or a digital custom EDID file assigned to an analog input, the display may not appear correctly.

Filtering available EDID

Use the **Filter** tab to limit the number of available EDID displayed in the Favorites, Available EDID, and Connected Outputs panes.

1. From the **Resolution** drop-down menu (see figure 45, **1**), select a specific resolution or **Any**.
2. From the **Refresh Rate** drop-down menu (**2**), select a specific refresh rate or **Any**.
3. Click the **Clear** button (**3**) to remove any active filters.

Assigning EDID

To assign EDID to selected inputs:

1. From the inputs group box (table of inputs) on the right, select the check boxes for the desired inputs (see [figure 45](#), **8** on page 63).
2. From the Favorites, Connected Outputs, or Available EDID pane (**4-6**) on the left, select the desired EDID.
3. From the inputs group box, click the **Assign** button (**9**) to assign EDID to the selected input or inputs.

To assign EDID to all inputs:

1. From the Favorites, Connected Outputs, or Available EDID pane (**4-6**), select an EDID.
2. From the inputs group box, click the **Assign to All** button (**10**).

NOTE: Checked or unchecked inputs are ignored and the EDID is assigned to all inputs.

To match the selected inputs to the current output resolution:

Matching the output resolution is the default value for all inputs.

1. From the inputs group box (table of inputs) on the right, select the check boxes for the desired inputs (**8**).
2. In the Output Resolution panel, click the **Match Output** button (**7**).

Adding EDID to the EDID Library

1. Click the **Add EDID to Library** button (**11**). The Add EDID to Library window opens.
2. Navigate to the desired EDID file location and select it.

NOTE: Valid EDID files have a .bin file extension.

3. Click the **Open** button. The EDID is added to the Available EDID pane (**6**).

Saving EDID to the EDID Library

1. From the Favorites or Connected Outputs pane (**4-5**), right-click on an EDID.
2. Select **Save to EDID Library**.
3. Click the **OK** button to save the file.

NOTE: Saving a factory scaler EDID exports an HDMI, LPCM-2Ch EDID to the PC. The file is saved as a .bin file.

Image Settings Page

From this page, signal sampling and picture control settings can be adjusted, user and input presets can be saved and recalled, and overscan settings can be applied. Click the **Image Settings** icon (see [figure 40](#), ③ on page 60) on the Global Navigation Bar to open the Image Settings page.

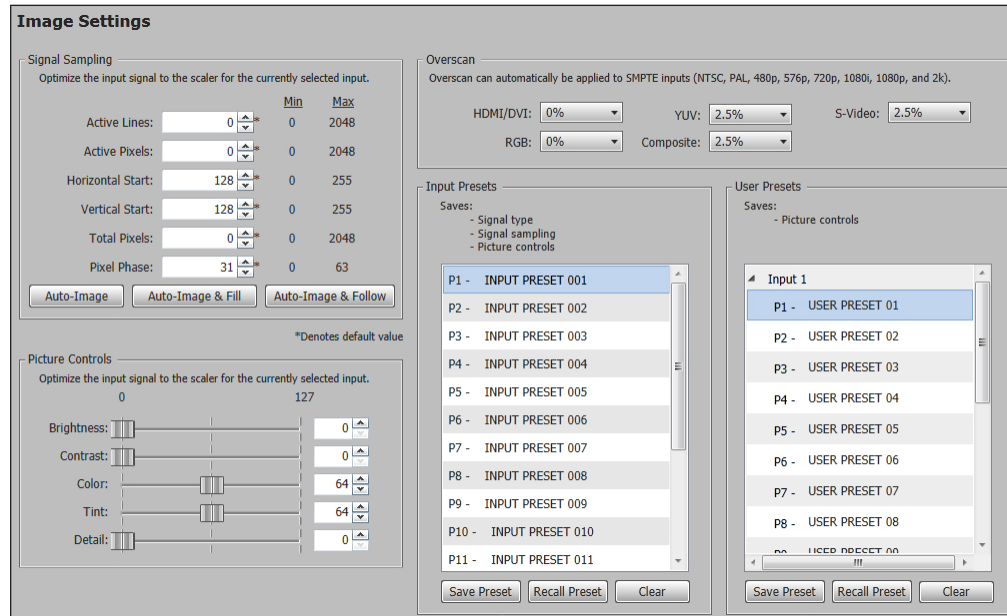

Figure 46. Image Settings Page

Signal Sampling panel

Signal sampling optimizes the input signal to the scaler for the currently selected input.

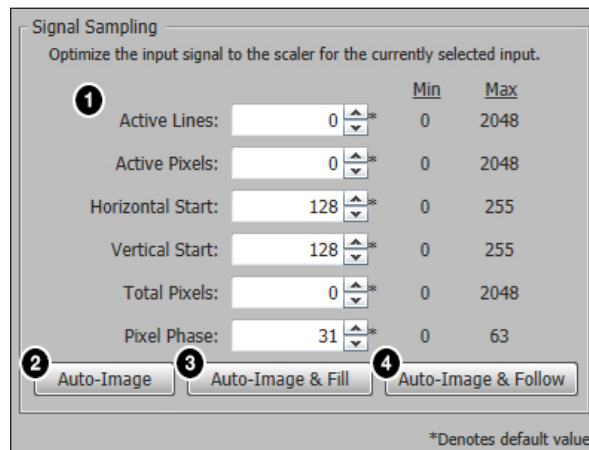

Figure 47. Signal Sampling Panel

To manually adjust signal sampling settings, enter a value within the Min and Max values displayed to the right of each adjustable settings (see [figure 47](#), ①) or click the **Up** or **Down** arrows. An asterisk beside a chosen value indicates that it is a default value.

To automatically adjust these settings, perform one of the following:

- Click the **Auto-Image** button (②) to perform a one-time Auto-Image.
- Click the **Auto-Image & Fill** button (③) to perform a one-time Auto-Image and fill the entire video output (ignores aspect ratio setting).
- Click the **Auto-Image & Follow** button (④) to perform a one-time Auto-Image and to maintain the aspect ratio of the input signal (ignores aspect ratio setting).

Picture Controls panel

The Pictures Controls panel shows adjustable image settings for the selected input.

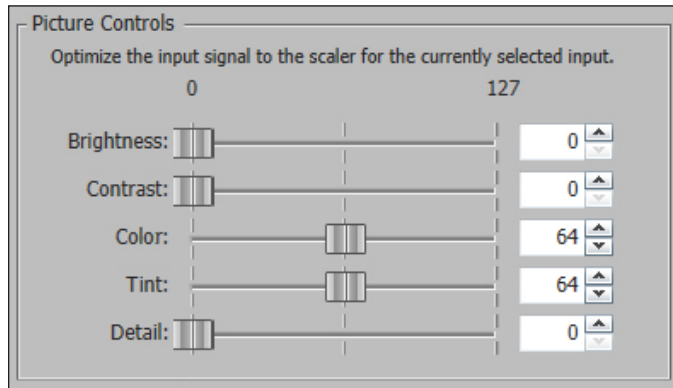

Figure 48. Picture Controls Panel

To adjust the picture settings, click and drag the associated slider for any applicable image setting (brightness, contrast, color, tint, or detail) to the desired value.

Alternatively, enter a value within the field associated with the image setting, or click the **Up** and **Down** arrows to change the value in the field.

Overscan panel

Overscan mode zooms and crops SMPTE input resolutions to mask edge effects and ancillary data common in broadcast signals. Issuing an Auto-Image with overscan enabled runs an Auto Phase routine (YUV and RGB only) and centers and sizes the input.

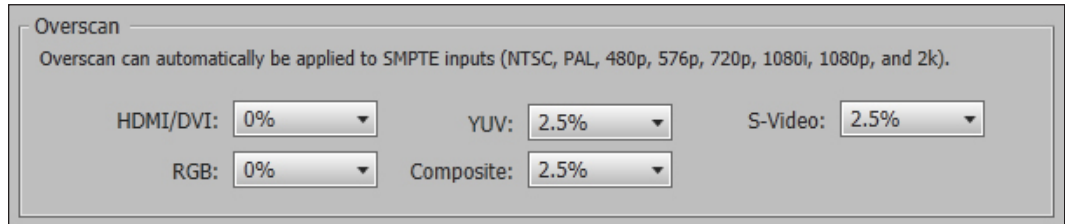

Figure 49. Overscan Panel

For each input signal type, select a value from the corresponding drop-down menu.

NOTE: Setting a value of 0% disables overscan for the corresponding input format.

Preset panels overview

Presets save output settings to be recalled (see the following table for a comparison of saved settings for input and user presets).

Settings Included Within Presets		
Setting	User Preset	Input Preset
Horizontal and Vertical Start		X
Active Lines		X
Pixel Phase		X
Active Pixels		X
Total Pixels		X
Input Type		X
Audio Gain and Attenuation		X
Film Detect		X
Brightness and Contrast	X	X
Color and Tint	X	X
Detail	X	X
Image Size and Position	X	X
Preset Name	X	X

NOTE: User presets can be saved on one input resolution and recalled on a different one. Input presets can only be recalled on the same input resolution that was present when the preset was saved.

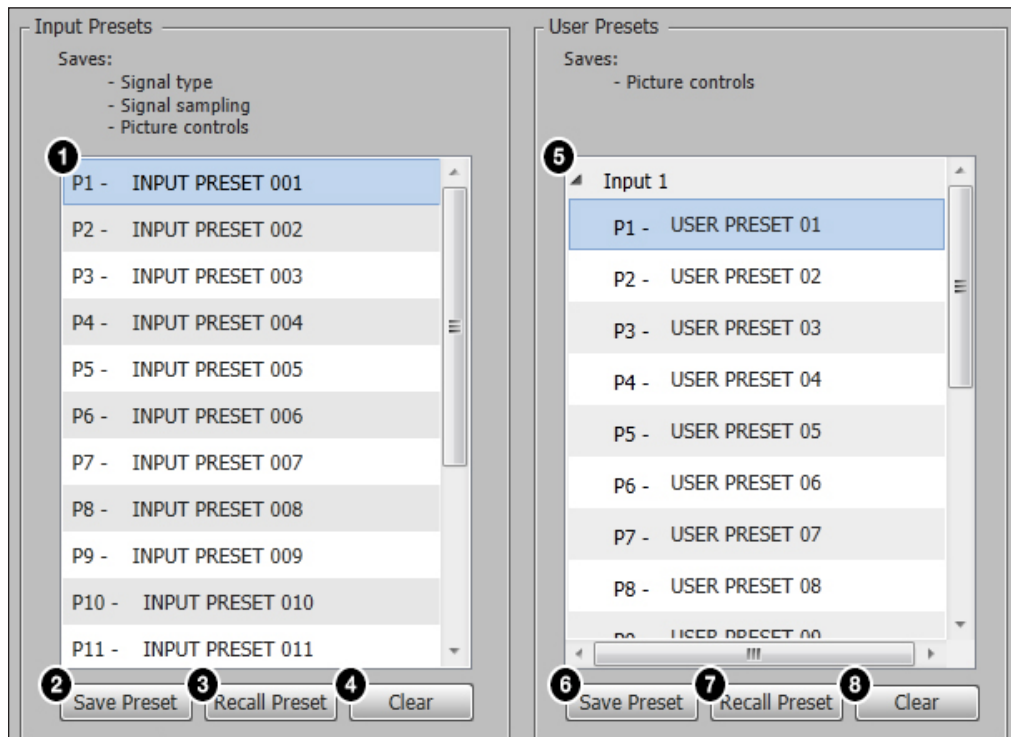

Figure 50. Input and User Presets Panels

Input presets

There are 16 presets that are global to all inputs. The presets contain all of the settings for an input when used with an upstream matrix switcher. Input presets save signal type, signal sampling, and picture control settings.

To save an input preset:

1. From the Input Presets list (see [figure 50](#), **1** on page 67), select the desired preset.
2. Click the **Save Preset** button (**2**). If the selected preset already has stored information on it, the Presets dialog box opens. Click the **Overwrite** button to erase the previous data and save the new settings. Click the **Cancel** button to cancel pending changes.

To rename a preset:

1. In the **Input Preset Name** column, double-click an **Input Preset Name** (**1**).
2. Change the name as desired.
3. Press the <Enter> key to save the new name.

To recall an input preset:

1. From the Input Presets list (**1**), select the desired preset.
2. Click the **Recall Preset** button (**3**). The Presets dialog box opens.
3. Click the **Recall** button to recall the preset. Click the **Cancel** button to return to the Image Settings page.

To clear a preset:

1. From the Input Presets list (**1**), select the desired preset.
2. Click the **Clear** button (**4**). The Presets dialog box opens.
3. Click the **Clear** button to erase saved data. Click the **Cancel** button to return to the Image Settings page.

User Presets

There are 16 user presets per input to save picture control settings only.

To save a user preset:

1. From the User Presets list (**5**), select the desired preset.
2. Click the **Save Preset** button (**6**). If the selected preset already has stored information on it, the Presets dialog box opens. Click the **Overwrite** button to erase the previous data and save the new settings. Click the **Cancel** button to cancel pending changes.

To rename a preset:

1. In the **User Preset Name** column, double-click a **User Preset Name** (**5**).
2. Change the name as desired.
3. Press the <Enter> key to save the new name.

To recall a user preset:

1. From the User Presets list (**5**), select the desired preset.
2. Click the **Recall Preset** button (**7**). The Presets dialog box opens.
3. Click the **Recall** button to recall the preset. Click the **Cancel** button to return to the Image Settings page.

To clear a preset:

1. From the User Presets list (**5**), select the desired preset.
2. Click the **Clear** button (**8**). The Presets dialog box opens.
3. Click the **Clear** button to erase saved data. Click the **Cancel** button to return to the Image Settings page.

Size and Position Page

The **Size and Position** page provides three methods of adjusting image output size and position: graphically, numerically, or automatically with Auto-Image. Click the **Size and Position** icon (see [figure 40](#), ④ on page 60) on the **Global Navigation Bar** to open the **Size and Position** page.

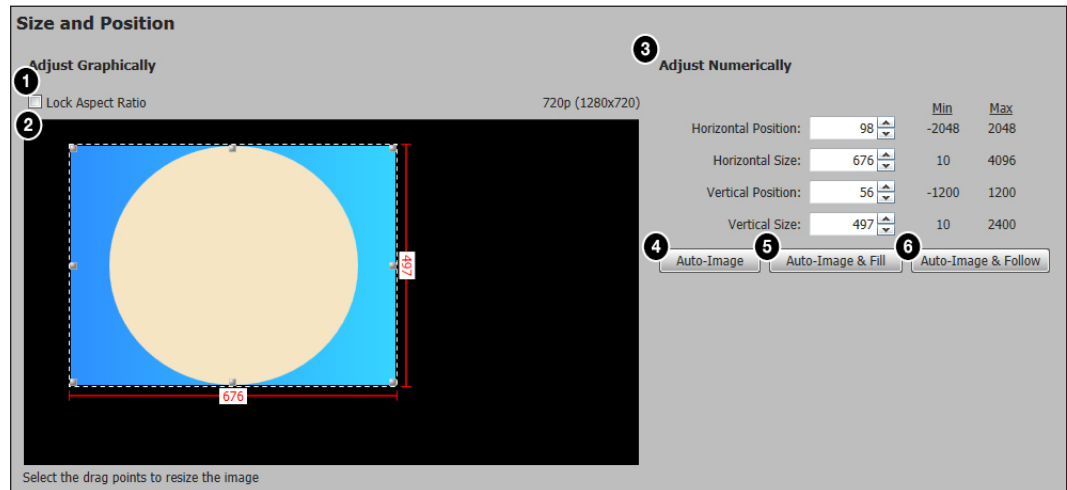

Figure 51. Size and Position Page

To adjust the size and position graphically:

If desired, click the **Lock Aspect Ratio** check box (see [figure 51](#), ①) to constrain the proportions of the output image. With this selected, the horizontal or vertical dimension of the output will change relative to the change of the other dimension.

1. Click and drag the drag points of the sample image (②) to resize the image within the designated space (defined by the black area in [figure 51](#)).
2. Click anywhere inside the sample image (see the blue rectangle with a circle inside in [figure 51](#)) and drag it anywhere within the designated space to reposition the image.

To adjust the size and position numerically:

1. Enter a value or click the **Up** or **Down** arrow in the **Horizontal Size** and **Vertical Size** fields (③).
2. Enter a value or click the **Up** or **Down** arrow in the **Horizontal Position** and **Vertical Position** fields (③).

To adjust the size and position automatically:

To automatically adjust these settings, perform one of the following (see [Auto-Image](#) on page 20 for more details on Auto-Image settings):

- Click the **Auto-Image** button (④) to perform a one-time Auto-Image.
- Click the **Auto-Image & Fill** button (⑤) to perform a one-time Auto-Image and fill the entire video output (ignores aspect ratio settings).
- Click the **Auto-Image & Follow** button (⑥) to perform a one-time Auto-Image and to maintain the aspect ratio of the input signal (ignores aspect ratio settings).

Audio Configuration Page

From the Audio Config page, audio inputs and outputs can be configured and mixed. Click the **Audio Config** icon (see figure 40, 5 on page 60) on the Global Navigation Bar to open this page.

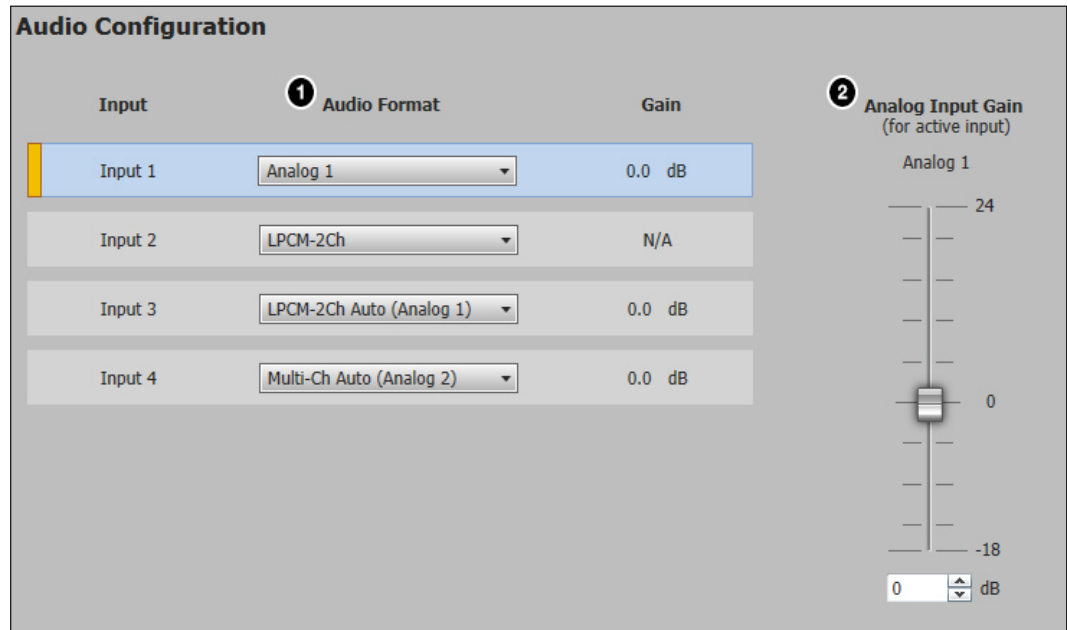

Figure 52. Audio Configuration Page

1. From the **Audio Format** drop-down menu (see figure 52, 1), select the desired audio input format. The audio input format specifies whether the audio input is analog, digital, or not to be sent to the output.

NOTE: Analog Input gain adjustment applies only to analog signals. The Input Gain fader is available only when the audio format is set to **Analog 1**, **Analog 2**, **LPCM-2Ch Auto (Analog 1)**, **Multi-Ch Auto (Analog 1)**, **LPCM-2Ch Auto (Analog 2)**, or **Multi-Ch Auto (Analog 2)**.

For input 1, available formats include:

- **None** — Audio is not sent to the output. This option sets “No Audio” EDID.
- **Analog 1** — Analog audio from analog audio input 1 (TRS) is sent to the output. This option sets “No Audio” EDID.
- **Analog 2** — Analog audio from analog audio input 2 (captive screw) is sent to the output. This option sets “No Audio” EDID.

For all other inputs, available formats include:

- **None** — Audio is not sent to the output. This option sets “No Audio” EDID.
- **Analog 1** — Analog audio from analog input 1 is sent to the output. This option sets “No Audio” EDID.
- **Analog 2** — Analog audio from analog input 2 is sent to the output. This option sets “No Audio” EDID.
- **LPCM-2Ch** — The digital input is configured to receive 2-channel LPCM audio. This option sets 2Ch audio EDID.
- **Multi-Ch** — The digital input is configured to receive multi-channel audio. If multi-channel audio is not available, 2-channel LPCM audio is passed to the digital outputs. This option sets Multi-Ch audio EDID.

- **LPCM-2Ch Auto (Analog 1)** — The digital input is configured to receive 2-channel LPCM audio. If 2-channel LPCM audio is not detected, the input switches to analog input 1 to send to the output. This option sets 2Ch audio EDID.
 - **Multi-Ch Auto (Analog 1)** — The digital input is configured to receive multi-channel audio, but will pass 2-channel LPCM if multi-channel audio is not available. If neither multi-channel audio nor 2-channel LPCM audio is detected, the input switches to analog input 1 to send to the output. This option sets Multi-Ch audio EDID.
 - **LPCM-2Ch Auto (Analog 2)** — The digital input is configured to receive 2-channel LPCM audio. If 2-channel LPCM audio is not detected, the input switches to analog input 2 to send to the output. This option sets 2Ch audio EDID.
 - **Multi-Ch Auto (Analog 2)** — The digital input is configured to receive multi-channel audio, but will pass 2-channel LPCM if multi-channel audio is not available. If neither multi-channel audio nor 2-channel LPCM audio is detected, the input switches to analog input 2 to send to the output. This option sets Multi-Ch audio EDID.
2. For analog audio inputs, adjust the level using any of the following methods (see [figure 52](#), ② on page 70):
- Click and drag the fader handle to the desired level.
 - Press the <Up Arrow> or <Down Arrow> key to respectively increase or decrease the level in 1 dB increments.
 - Press the <Page Up> or <Page Down> key to respectively increase or decrease the level in 5 dB increments.
 - Click in the level text field below the fader and enter a new value. Press the <Enter> or <Tab> key to apply the change.
 - Click the **Up** or **Down** arrow button to the right of the level text field to respectively increase or decrease the level in 1 dB increments.

Preset Management Page

The Preset Management page gives access to input and user presets. Click the **Preset Management** icon (see [figure 40](#), ⑥ on page 60) on the Global Navigation Bar to open the Preset Management page.

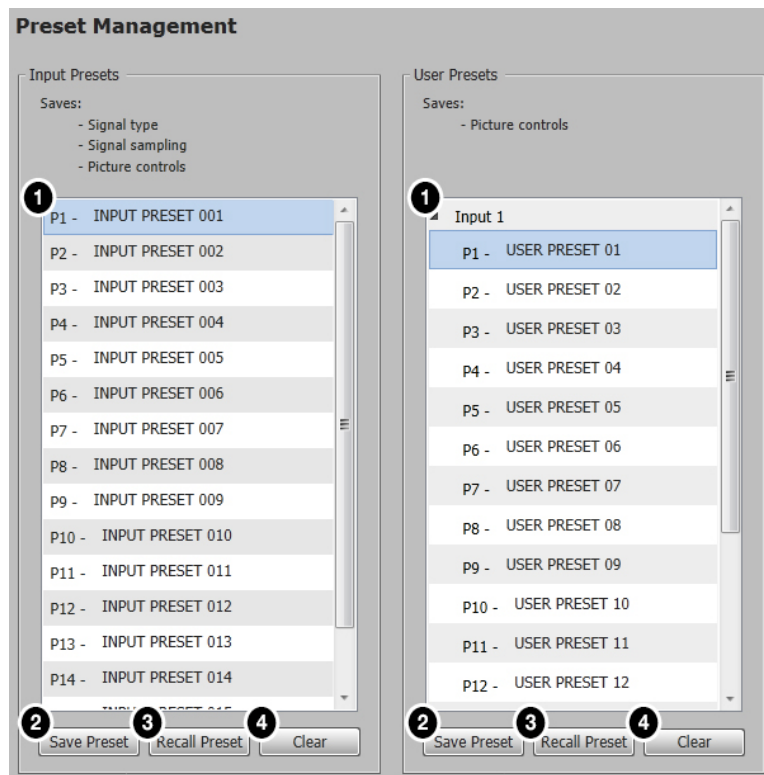

Figure 53. Preset Management Page

For information on presets, see [Preset panels Overview](#) on page 67.

To save a preset:

1. Select the input preset or user preset (see [figure 53](#), ①) to store the current configuration.
2. Click the **Save Preset** button (②) located in the same **Input Presets** or **User Presets** panel. If the selected preset already has stored information on it, a confirmation dialog box opens.
3. Click the **Overwrite** button to erase the previous data and save the new settings or click the **Cancel** button to return to the Preset Management page.

To recall a preset:

1. Select the input preset or user preset (①) to be recalled.
2. Click the **Recall Preset** button (③) located in the same **Input Presets** or **User Presets** panel. A confirmation dialog box opens.
3. Click the **Recall** button to recall the preset or click the **Cancel** button to return to the Preset Management page.

To clear a preset:

1. Select the input preset or user preset (see [figure 53](#), **1** on page 72) to be cleared.
2. Click the **Clear** button (**4**) located in the same section of the screen. A confirmation dialog box opens.
3. Click the **Clear** button to erase saved data or click the **Cancel** button to return to the Preset Management page.

To rename a preset:

1. Double-click a preset name or right-click a preset name (**1**) and select **Rename**.
2. Enter a new preset name and press the <Enter> key.

General Settings Page

The **General Settings** page allows configuration of screen saver settings, auto switch modes, HDCP notifications, video and sync muting, and HDCP modes. Click the **General Settings** icon (see [figure 40](#), **7** on page 60) on the **Global Navigation Bar** to open the **General Settings** page.

The screenshot displays the **General Settings** page with a **Hardware Settings** button at the top. The page is divided into several sections:

- Screen Saver:** Displays when no input signal is detected. Options include **Black** (selected), **Blue with On Screen Display (OSD) Bug**, and a checkbox for **Disable Sync After:** set to 60 seconds (0-500).
- HDCP Notification:** Select display color when sending HDCP content on a non-compliant display. Options include **Black** and **Green** (selected).
- Contact Mute and Tally LED:** Includes **Contact Mute:** with options **None**, **A/V Mute** (selected), and **Sync Mute**; and **Tally LED:** with options **Always on for selected input** (selected), **Blinks when selected input is muted**, and **Off when selected input is muted**.
- Front Panel Lockout (Exec Mode):** Options include **Unlock Front Panel** (selected), **Mode 1: Lock Front Panel**, and **Mode 2: Limit Front Panel to Input Selection**.
- Auto Switch:** Includes a checked **Enable Auto Switch** checkbox and options **Priority to the highest active input number** and **Priority to the lowest active input number** (selected).
- HDCP Mode:** Options include **Follow Input** (selected), **Always Encrypt Output**, **Follow Input (with continuous DVI trials)**, and **Always Encrypt Output (with continuous DVI trials)**.

Figure 54. General Settings Page

To access the **Hardware Settings** dialog box, click the **Hardware Settings** button.

Screen Saver panel

When no active video is detected on the selected input, the screen saver mode is activated. The output sync can be disabled after a user-set duration, which allows display devices to go into a low power, standby state.

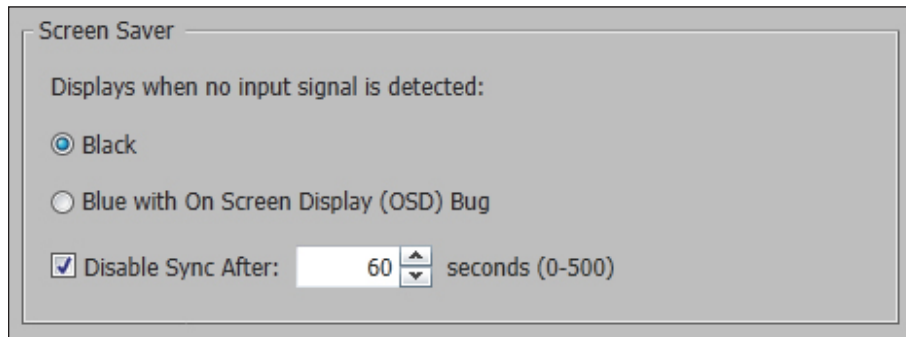

Figure 55. Screen Saver Panel

1. Click one of the radio buttons to select a display when the screen saver is enabled.
 - **Black** — Mutes video output to black for a set duration before disabling output sync (default).
 - **Blue with On Screen Display (OSD) Bug** — Displays a blue background with a moving OSD message that indicates "<scaler model>: Input <number> No Signal" for a set duration before disabling the output sync.
2. Select a duration to display the screen saver before the output sync is disabled.
 - Select the **Disable Sync After** check box to disable the scaler output sync after a set duration without an active input. When selected, the **Duration On Screen** field becomes available.
 - In the **Duration** field, enter a value in the field or click the **Up** and **Down** arrows to specify a duration to wait before disabling output sync during inactivity. The default is to never disable the output sync.

HDCP Notification panel

HDCP notification indicates when HDCP content restrictions prevent a video signal from passing.

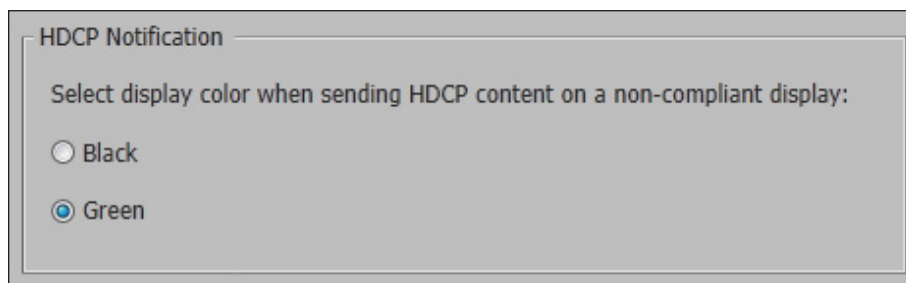

Figure 56. HDCP Notification Panel

Select one of the following radio buttons:

- **Black** — Displays a black or muted screen when an encrypted source is sent to a display that is not HDCP-compliant.
- **Green** — Displays a green screen when an encrypted source is displayed on a sink that is not HDCP-compliant (default).

Contact Mute and Tally LED panel

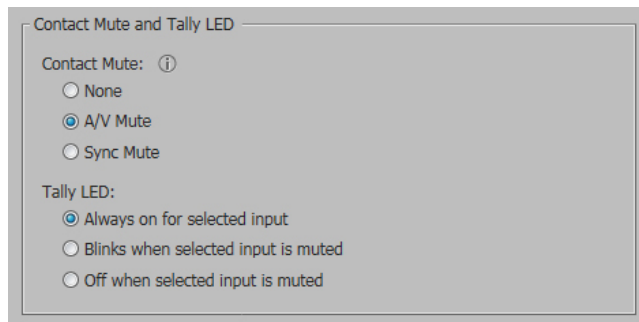

Figure 57. Contact Mute and Tally LED Panel

The Tally LED options are only available if contact mute is set to **A/V Mute** or **Sync Mute**.

Contact Mute options:

- **None** — The initial contact closure provides input switching to the corresponding input. Any additional button presses or contact closures on the input have no additional effect.
- **A/V Mute** — Once an input is selected, additional contact closure pulses mutes or unmutes audio and video on the output.
- **Sync Mute** — Once an input is selected, additional contact closure pulses mutes or unmutes audio and video sync on the output.

Tally LED options:

- **Always On** — The LED on the corresponding tally output pin to the selected input remains lit at all times.
- **Mute Off** — The LED on the corresponding tally output pin to the selected input turns off when video or sync is muted; otherwise, the LED remains lit.
- **Mute Blink** — The LED on the corresponding tally output pin to the selected input blinks when video or sync is muted; otherwise, the LED remains lit.

Front Panel Lockout (Exec Mode) panel

The Front Panel Lockout mode (executive mode) limits the available features on the front panel of the scaler.

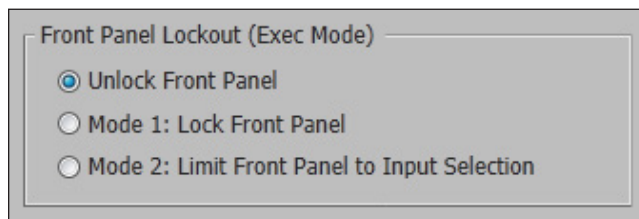

Figure 58. Front Panel Lockout (Exec Mode) Panel

Select one of the following radio buttons:

- **Unlock Front Panel** — Enables the front panel control.
- **Mode 1: Lock Front Panel** — Disables front panel control.
- **Mode 2: Limit Front Panel to Input Selection** — Limits front panel control to input switching and applying an Auto-Image.

Auto Switch panel

Auto switch mode automatically switches inputs based on detected input signals.

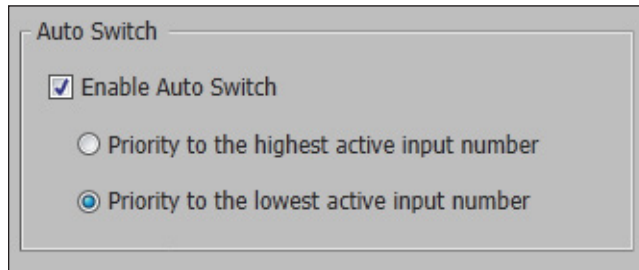

Figure 59. Auto Switch Panel

1. Select the **Enable Auto Switch** check box to enable auto switch mode.
2. Click the radio button of the desired type of auto switch mode from the following:
 - **Priority to the highest active input number** — Automatically switches the input to the highest numbered active input.
 - **Priority to the lowest active input number** — Automatically switches the input to the lowest numbered active input.

HDCP Mode panel

When enabled, the HDCP mode can be set to either follow the current input, with or without DVI trials, or always encrypt the output, with or without DVI trials.

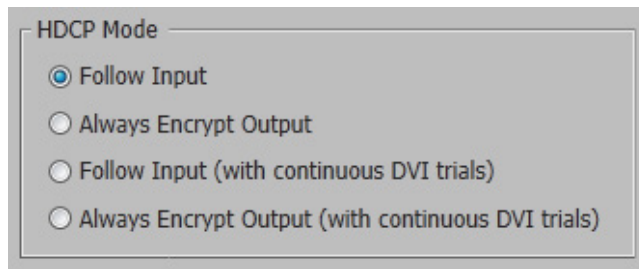

Figure 60. HDCP Mode Panel

Select one of the following radio buttons:

- **Follow Input** — Encrypts the output only when required by the selected input source.
- **Always Encrypt Output** — Always encrypts the output, regardless of the HDCP status of the selected input source.
- **Follow Input (with continuous DVI trials)** — Encrypts the output only when required by the selected input source. Use this setting when DVI sink devices initially pass HDCP encrypted content, but intermittently display a green HDCP notification screen after a power cycle or resuming from sleep mode.
- **Always Encrypt Output (with continuous DVI trials)** — Always encrypts the output regardless of the HDCP status of the selected input source. Use this setting when DVI sink devices initially pass HDCP encrypted content, but intermittently display a green HDCP notification screen after a power cycle or resuming from sleep mode.

Reference Information

This section contains reference or supplemental information. Topics in this section include:

- [Mounting](#)
- [Downloading Updated Firmware](#)

Mounting

Tabletop Mounting

Attach the provided rubber feet to the bottom four corners of the enclosure.

Rack Mounting

The scalars can be mounted into racks with the pre-installed rack ears (see [UL Guidelines for rack mounted devices](#) on page 78). To install the device, install a rack shelf to the rack and use the provided screws to attach the device to the rack shelf.

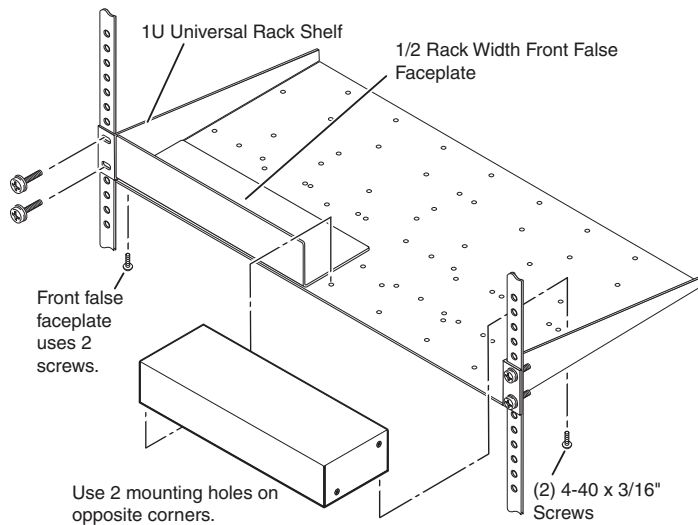

Figure 61. Half Rack Shelf Mounting

UL Guidelines for rack mounted devices

The following Underwriters Laboratories (UL) guidelines pertain to the safe installation of the scaler in a rack.

- 1. Elevated operating ambient temperature** — If the equipment is installed in a closed or multi-unit rack assembly, the operating ambient temperature of the rack environment may be greater than room ambient temperature. Therefore, install the scaler in an environment compatible with the maximum ambient temperature ($T_{ma} = +122\text{ }^{\circ}\text{F}$, $+50\text{ }^{\circ}\text{C}$) specified by Extron.
- 2. Reduced air flow** — Install the equipment in a rack so that the amount of air flow required for safe operation of the equipment is not compromised.
- 3. Mechanical loading** — Mount the equipment in the rack so that a hazardous condition is not achieved due to uneven mechanical loading.
- 4. Circuit overloading** — Connect the equipment to the supply circuit and consider the effect that circuit overloading might have on overcurrent protection and supply wiring. Appropriate consideration of equipment nameplate ratings should be used when addressing this concern.
- 5. Reliable earthing (grounding)** — Maintain reliable grounding of rack-mounted equipment. Pay particular attention to supply connections other than direct connections to the branch circuit (e.g. use of power strips).

Furniture Mounting

Go to www.extron.com, for a list of available furniture mounting kits. To install the scaler to furniture, follow the mounting kit instructions.

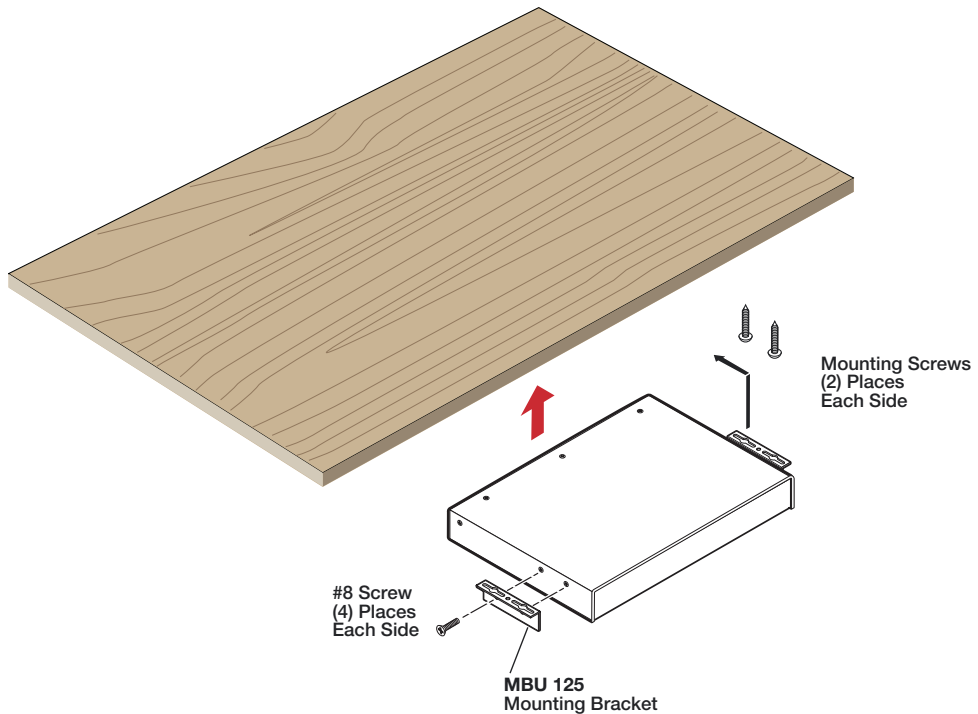

Figure 62. Under-Desk Mounting

Downloading Updated Firmware

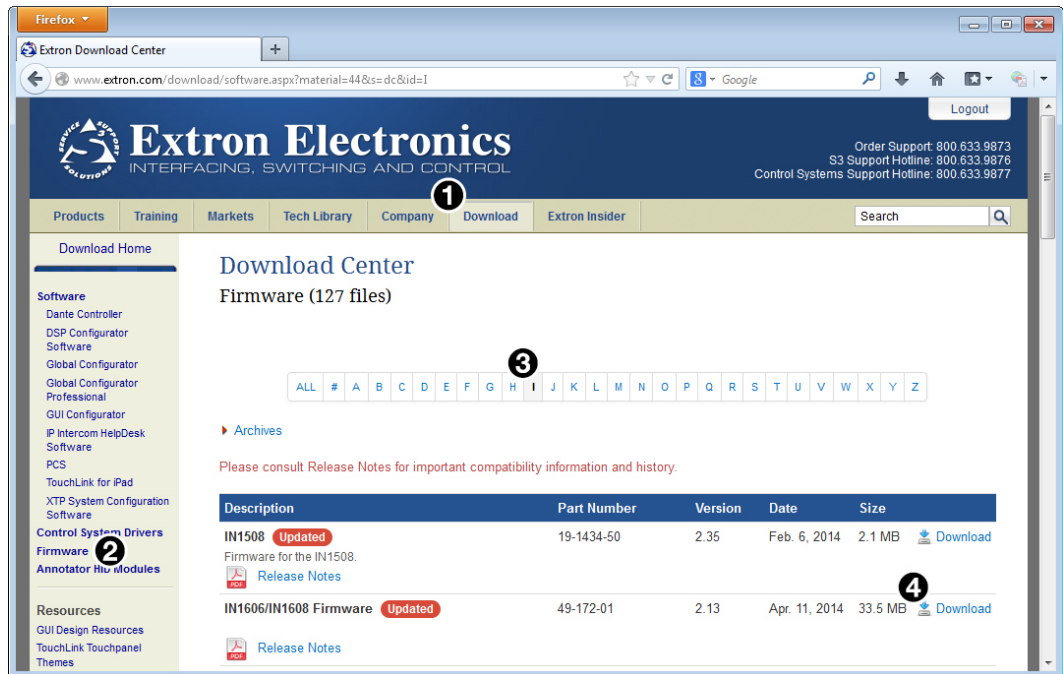

Figure 63. Downloading Firmware from the Extron Website

1. On the Extron [website](#), click the **Download** tab (1).
2. From the left sidebar, click the **Firmware** link (2).
3. Navigate to the IN1604 DTP or IN1604 HD (3).
4. Ensure the available firmware version is a later version than the current one on the device.

NOTE: The firmware release notes provide details about the changes between different firmware versions. The file can be downloaded from the same page as the firmware.

5. Click the **Download** link (4) to the right of the desired device.
6. Submit required information to start the download. Note where the file is saved.
7. From the save location, open the executable (.exe) file.
8. Follow the instructions on the Installation Wizard screens to install the new firmware on the computer. A Release Notes file, giving information on what has changed in the new firmware version, and a set of instructions for updating the firmware are also loaded.
9. Use Extron Firmware Loader or the Product Configuration Software (see [Update Firmware](#) on page 58) to upload firmware from the PC to the scaler.

Extron Warranty

Extron Electronics warrants this product against defects in materials and workmanship for a period of three years from the date of purchase. In the event of malfunction during the warranty period attributable directly to faulty workmanship and/or materials, Extron Electronics will, at its option, repair or replace said products or components, to whatever extent it shall deem necessary to restore said product to proper operating condition, provided that it is returned within the warranty period, with proof of purchase and description of malfunction to:

USA, Canada, South America, and Central America:

Extron Electronics
1230 South Lewis Street
Anaheim, CA 92805
U.S.A.

Japan:

Extron Electronics, Japan
Kyodo Building, 16 Ichibancho
Chiyoda-ku, Tokyo 102-0082
Japan

Europe and Africa:

Extron Europe
Hanzeboulevard 10
3825 PH Amersfoort
The Netherlands

China:

Extron China
686 Ronghua Road
Songjiang District
Shanghai 201611
China

Asia:

Extron Asia Pte Ltd
135 Joo Seng Road, #04-01
PM Industrial Bldg.
Singapore 368363
Singapore

Middle East:

Extron Middle East
Dubai Airport Free Zone
F13, PO Box 293666
United Arab Emirates, Dubai

This Limited Warranty does not apply if the fault has been caused by misuse, improper handling care, electrical or mechanical abuse, abnormal operating conditions, or if modifications were made to the product that were not authorized by Extron.

NOTE: If a product is defective, please call Extron and ask for an Application Engineer to receive an RA (Return Authorization) number. This will begin the repair process.

USA: 714.491.1500 or 800.633.9876
Asia: 65.6383.4400

Europe: 31.33.453.4040
Japan: 81.3.3511.7655

Units must be returned insured, with shipping charges prepaid. If not insured, you assume the risk of loss or damage during shipment. Returned units must include the serial number and a description of the problem, as well as the name of the person to contact in case there are any questions.

Extron Electronics makes no further warranties either expressed or implied with respect to the product and its quality, performance, merchantability, or fitness for any particular use. In no event will Extron Electronics be liable for direct, indirect, or consequential damages resulting from any defect in this product even if Extron Electronics has been advised of such damage.

Please note that laws vary from state to state and country to country, and that some provisions of this warranty may not apply to you.

<p>Extron Headquarters +1.800.633.9876 (Inside USA/Canada Only) Extron USA - West +1.714.491.1500 +1.714.491.1517 FAX</p>	<p>Extron Europe +800.3987.6673 (Inside Europe Only) +31.33.453.4040 +31.33.453.4050 FAX</p>	<p>Extron Asia +65.6383.4400 +65.6383.4664 FAX</p>	<p>Extron Japan +81.3.3511.7655 +81.3.3511.7656 FAX</p>	<p>Extron China +86.21.3760.1568 +86.21.3760.1566 FAX</p>	<p>Extron Middle East +971.4.299.1800 +971.4.299.1880 FAX</p>	<p>Extron Korea +82.2.3444.1571 +82.2.3444.1575 FAX</p>	<p>Extron India 1800.3070.3777 Inside India Only +91.80.3055.3777 +91.80.3055.3737 FAX</p>
--	---	---	--	--	--	--	---