

EDID 101H 4K

EDID Emulator with EDID Minder for HDMI



Extron Electronics
INTERFACING, SWITCHING AND CONTROL

Safety Instructions

Safety Instructions • English

WARNING: This symbol, , when used on the product, is intended to alert the user of the presence of uninsulated dangerous voltage within the product's enclosure that may present a risk of electric shock.

ATTENTION: This symbol, , when used on the product, is intended to alert the user of important operating and maintenance (servicing) instructions in the literature provided with the equipment.

For information on safety guidelines, regulatory compliances, EMI/EMF compatibility, accessibility, and related topics, see the Extron Safety and Regulatory Compliance Guide, part number 68-290-01, on the Extron website, www.extron.com.

Sicherheitsanweisungen • Deutsch

WARNUNG: Dieses Symbol , auf dem Produkt soll den Benutzer darauf aufmerksam machen, dass im Inneren des Gehäuses dieses Produktes gefährliche Spannungen herrschen, die nicht isoliert sind und die einen elektrischen Schlag verursachen können.

VORSICHT: Dieses Symbol , auf dem Produkt soll dem Benutzer in der im Lieferumfang enthaltenen Dokumentation besonders wichtige Hinweise zur Bedienung und Wartung (Instandhaltung) geben.

Weitere Informationen über die Sicherheitsrichtlinien, Produkthandhabung, EMI/EMF-Kompatibilität, Zugänglichkeit und verwandte Themen finden Sie in den Extron-Richtlinien für Sicherheit und Handhabung (Artikelnummer 68-290-01) auf der Extron-Website, www.extron.com.

Instrucciones de seguridad • Español

ADVERTENCIA: Este símbolo, , cuando se utiliza en el producto, avisa al usuario de la presencia de voltaje peligroso sin aislar dentro del producto, lo que puede representar un riesgo de descarga eléctrica.

ATENCIÓN: Este símbolo, , cuando se utiliza en el producto, avisa al usuario de la presencia de importantes instrucciones de uso y mantenimiento recogidas en la documentación proporcionada con el equipo.

Para obtener información sobre directrices de seguridad, cumplimiento de normativas, compatibilidad electromagnética, accesibilidad y temas relacionados, consulte la Guía de cumplimiento de normativas y seguridad de Extron, referencia 68-290-01, en el sitio Web de Extron, www.extron.com.

Instructions de sécurité • Français

AVERTISSEMENT : Ce pictogramme, , lorsqu'il est utilisé sur le produit, signale à l'utilisateur la présence à l'intérieur du boîtier du produit d'une tension électrique dangereuse susceptible de provoquer un choc électrique.

ATTENTION : Ce pictogramme, , lorsqu'il est utilisé sur le produit, signale à l'utilisateur des instructions d'utilisation ou de maintenance importantes qui se trouvent dans la documentation fournie avec le matériel.

Pour en savoir plus sur les règles de sécurité, la conformité à la réglementation, la compatibilité EMI/EMF, l'accessibilité, et autres sujets connexes, lisez les informations de sécurité et de conformité Extron, réf. 68-290-01, sur le site Extron, www.extron.com.

Istruzioni di sicurezza • Italiano

AVVERTENZA: Il simbolo, , se usato sul prodotto, serve ad avvertire l'utente della presenza di tensione non isolata pericolosa all'interno del contenitore del prodotto che può costituire un rischio di scosse elettriche.

ATTENZIONE: Il simbolo, , se usato sul prodotto, serve ad avvertire l'utente della presenza di importanti istruzioni di funzionamento e manutenzione nella documentazione fornita con l'apparecchio.

Per informazioni su parametri di sicurezza, conformità alle normative, compatibilità EMI/EMF, accessibilità e argomenti simili, fare riferimento alla Guida alla conformità normativa e di sicurezza di Extron, cod. articolo 68-290-01, sul sito web di Extron, www.extron.com.

Instrukcje bezpieczeństwa • Polska

OSTRZEŻENIE: Ten symbol, , gdy używany na produkt, ma na celu poinformować użytkownika o obecności izolowanego i niebezpiecznego napięcia wewnątrz obudowy produktu, który może stanowić zagrożenie porażenia prądem elektrycznym.

UWAGI: Ten symbol, , gdy używany na produkt, jest przeznaczony do ostrzegania użytkownika ważne operacyjne oraz instrukcje konserwacji (obsługi) w literaturze, wyposażone w sprzęt.

Informacji na temat wytycznych w sprawie bezpieczeństwa, regulacji wzajemnej zgodności, zgodność EMI/EMF, dostępności i Tematy pokrewne, zobacz Extron bezpieczeństwa i regulacyjnego zgodności przewodnik, część numer 68-290-01, na stronie internetowej Extron, www.extron.com.

Инструкция по технике безопасности • Русский

ПРЕДУПРЕЖДЕНИЕ: Данный символ, , если указан на продукте, предупреждает пользователя о наличии неизолированного опасного напряжения внутри корпуса продукта, которое может привести к поражению электрическим током.

ВНИМАНИЕ: Данный символ, , если указан на продукте, предупреждает пользователя о наличии важных инструкций по эксплуатации и обслуживанию в руководстве, прилагаемом к данному оборудованию.

Для получения информации о правилах техники безопасности, соблюдении нормативных требований, электромагнитной совместимости (ЭМП/ЭДС), возможности доступа и других вопросах см. руководство по безопасности и соблюдению нормативных требований Extron на сайте Extron: , www.extron.com, номер по каталогу - 68-290-01.

安全说明 • 简体中文

警告:  产品上的这个标志意在警告用户该产品机壳内有暴露的危险电压, 有触电危险。

注意:  产品上的这个标志意在提示用户设备随附的用户手册中有重要的操作和维护(维修)说明。

关于我们产品的安全指南、遵循的规范、EMI/EMF 的兼容性、无障碍使用的特性等相关内容, 敬请访问 Extron 网站, www.extron.com, 参见 Extron 安全规范指南, 产品编号 68-290-01。

安全記事・繁體中文

警告: ⚠ 若產品上使用此符號, 是為了提醒使用者, 產品機殼內存在著可能會導致觸電之風險的未絕緣危險電壓。

注意: ⚠ 若產品上使用此符號, 是為了提醒使用者, 設備隨附的用戶手冊中有重要的操作和維護(維修)說明。

有關安全性指導方針、法規遵守、EMI/EMF 相容性、存取範圍和相關主題的詳細資訊, 請瀏覽 Extron 網站: www.extron.com, 然後參閱《Extron 安全性與法規遵守手冊》, 準則編號 68-290-01。

安全上のご注意・日本語

警告: この記号 ⚠ が製品上に表示されている場合は、筐体内に絶縁されていない高電圧が流れ、感電の危険があることを示しています。

注意: この記号 ⚠ が製品上に表示されている場合は、本機の取扱説明書に 記載されている重要な操作と保守(整備)の指示についてユーザーの注意を喚起するものです。

安全上のご注意、法規遵守、EMI/EMF適合性、その他の関連項目については、エクストロンのウェブサイト www.extron.com より『Extron Safety and Regulatory Compliance Guide』(P/N 68-290-01) をご覧ください。

안전 지침 · 한국어

경고: 이 기호 ⚠ 가 제품에 사용될 경우, 제품의 인클로저 내에 있는 접지되지 않은 위험한 전류로 인해 사용자가 감전될 위험이 있음을 경고합니다.

주의: 이 기호 ⚠ 가 제품에 사용될 경우, 장비와 함께 제공된 책자에 나와 있는 주요 운영 및 유지보수(정비) 지침을 경고합니다.

안전 가이드라인, 규제 준수, EMI/EMF 호환성, 접근성, 그리고 관련 항목에 대한 자세한 내용은 Extron 웹 사이트(www.extron.com)의 Extron 안전 및 규제 준수 안내서, 68-290-01 조항을 참조하십시오.

Copyright

© 2016 Extron Electronics. All rights reserved.

Trademarks

All trademarks mentioned in this guide are the properties of their respective owners.

The following registered trademarks(®), registered service marks(SM), and trademarks(TM) are the property of RGB Systems, Inc. or Extron Electronics (see the current list of trademarks on the [Terms of Use](#) page at www.extron.com):

Registered Trademarks (®)
Extron, AVTrac, Cable Cubby, CrossPoint, DTP, eBUS, EDID Manager, EDID Minder, Flat Field, FlexOS, Global Configurator, Global Scriptor, GlobalViewer, Hideaway, Inline, IP Intercom, IP Link, Key Minder, LinkLicense, LockIt, MediaLink, MediaPort, NetPA, PlenumVault, PoleVault, PowerCage, PURE3, Quantum, SoundField, SpeedMount, SpeedSwitch, System <i>INTEGRATOR</i> , TeamWork, TouchLink, V-Lock, VersaTools, VN-Matrix, VoiceLift, WallVault, WindoWall, XTP, and XTP Systems
Registered Service Mark (SM): S3 Service Support Solutions
Trademarks (TM)
AAP, AFL (Accu-Rate Frame Lock), ADSP (Advanced Digital Sync Processing), Auto-Image, CableCover, CDRS (Class D Ripple Suppression), DDSP (Digital Display Sync Processing), DMI (Dynamic Motion Interpolation), Driver Configurator, DSP Configurator, DSVP (Digital Sync Validation Processing), eLink, Entwine, EQIP, FastBite, FOX, FOXBOX, IP Intercom HelpDesk, MAA, MicroDigital, ProDSP, QS-FPC (QuickSwitch Front Panel Controller), Room Agent, Scope-Trigger, ShareLink, SIS, Simple Instruction Set, Skew-Free, SpeedNav, Triple-Action Switching, True4K, Vector™ 4K, WebShare, XTRA, ZipCaddy, and ZipClip

FCC Class A Notice

This equipment has been tested and found to comply with the limits for a Class A digital device, pursuant to part 15 of the FCC rules. The Class A limits provide reasonable protection against harmful interference when the equipment is operated in a commercial environment. This equipment generates, uses, and can radiate radio frequency energy and, if not installed and used in accordance with the instruction manual, may cause harmful interference to radio communications. Operation of this equipment in a residential area is likely to cause interference. This interference must be corrected at the expense of the user.

NOTE: For more information on safety guidelines, regulatory compliances, EMI/EMF compatibility, accessibility, and related topics, see the “[Extron Safety and Regulatory Compliance Guide](#)” on the Extron website.

Conventions Used in this Guide

Notifications

The following notifications are used in this guide:

ATTENTION:

- Risk of property damage.
- Risque de dommages matériels.

NOTE: A note draws attention to important information.**TIP:** A tip provides a suggestion to make working with the application easier.

Software Commands

Commands are written in the fonts shown here:

```
^ARMerge Scene,,0p1 scene 1,1 ^B 51 ^W ^C.0  
[01] R000400300004000080000600 [02] 35 [17] [03]
```

```
Esc X1 * X17 * X20 * X23 * X21 CE ←
```

NOTE: For commands and examples of computer or device responses used in this guide, the character “0” is used for the number zero and “O” is the capital letter “o.”

Computer responses and directory paths that do not have variables are written in the font shown here:

```
Reply from 208.132.180.48: bytes=32 times=2ms TTL=32  
C:\Program Files\Extron
```

Variables are written in slanted form as shown here:

```
ping xxx.xxx.xxx.xxx -t  
SOH R Data STX Command ETB ETX
```

Selectable items, such as menu names, menu options, buttons, tabs, and field names are written in the font shown here:

```
From the File menu, select New.  
Click the OK button.
```

Specifications Availability

Product specifications are available on the Extron website, www.extron.com.

Extron Glossary of Terms

A glossary of terms is available at <http://www.extron.com/technology/glossary.aspx>.



Contents

Introduction.....	1
About this Guide.....	1
About the EDID 101H 4K.....	1
EDID 101H 4K Features	1
Application Diagram	2
Installation and Configuration.....	3
Installation Overview	3
Front Panel Features.....	4
Rear Panel Features and Cabling.....	5
HDMI Connector LockIt Lacing Bracket.....	7
EDID Configuration	7
Assign Extron Factory EDID	7
Store an EDID in a User Slot	8
EDID Assignment Via SIS Commands	9
Configuration Software.....	10
Downloading Software from the Extron Website	10
Installing the Software.....	11
Starting the Software.....	13
Device Discovery Panel.....	13
Help Files.....	14
Offline Device Preview.....	14
Using the Software and Device Menus	15

Remote Communication and Control	16
Using Simple Instruction Set (SIS) Commands	16
Host-to-device Communications	16
Device-initiated Messages	16
Error Responses.....	16
Using the Command and Response Table	17
Symbol Definitions	18
Command and Response Table for SIS Commands	19
Reference Information	21
Mounting the EDID 101H 4K	21
Desktop Placement	21
Rack Mounting	21
Connecting to the USB Port	22
DataViewer	24
Updating the Firmware	25
Download and Install Firmware Loader	25
Downloading EDID 101H 4K Firmware	26
Loading EDID 101H 4K Firmware	27
Extron Warranty	29

Introduction

This section describes this user guide and the EDID 101H 4K, including:

- [About this Guide](#)
- [About the EDID 101H 4K](#)
- [EDID 101H 4K Features](#)
- [Application Diagram](#)

About this Guide

This guide contains information about the Extron EDID 101H 4K with instructions on how to install, configure, and operate the unit. Throughout this guide the EDID 101H 4K is referred to as the “EDID 101” or the “device”.

About the EDID 101H 4K

The Extron EDID 101H 4K is a single input, single output HDCP compliant EDID Emulator for HDMI signal sources supporting video rates up to 4K@30 Hz. It features EDID Minder, an Extron exclusive technology designed to provide automatic and continuous Extended Display Identification Data (EDID) management. EDID Minder ensures that the source powers up properly and reliably outputs content. Pre-stored EDID is communicated to the source based on a user-selected resolution and refresh rate. The EDID 101H 4K can also capture and store EDID information from a connected display.

The EDID 101H 4K is housed in a compact one-inch high, six-inch deep, quarter-rack width enclosure for convenient, discreet installation (see [Mounting the EDID 101H 4K](#) on page 21). An energy-efficient external universal power supply is included.

EDID 101H 4K Features

- **EDID Minder** — Automatically manages EDID communication between connected devices. EDID Minder ensures that all sources power up properly and reliably output content for display.
- **Selectable resolutions and refresh rates** — Pre-stored EDID is communicated to the source based on a user-selected resolution and refresh rate.
- **EDID capture mode** — When connected to a display, the EDID 101H 4K offers the option of capturing and then storing EDID information from the display device.
- **Supported HDMI specification** — Features include data rates up to 10.2 Gbps, Deep Color up to 12-bit, 3D, and CEC pass-through.
- **Supports multiple embedded audio formats** — The EDID 101H 4K is compatible with a broad range of multi-channel audio signals, providing reliable operation with HDMI sources.
- **Supports computer and video resolutions up to 4K** — Resolutions up to 4096x2160/30 with 4:4:4 chroma sampling at 8 bits of color.

- **HDCP compliant** — Ensures display of content-protected media and interoperability with other HDCP-compliant devices.
- **HDCP authentication and signal presence confirmation** — Provides real-time verification of HDCP status. This allows for simple, quick, and easy signal and HDCP verification through front panel LEDs, and USB, providing valuable feedback to a system operator or helpdesk support staff.
- **User-selectable HDCP authorization** — Allows the unit to appear HDCP compliant or non-HDCP compliant to the connected source, which is beneficial if the source automatically encrypts all content when connected to an HDCP-compliant device. Protected material is not passed in non-HDCP mode.
- **HDMI to DVI Interface Format Correction** — Automatically reformats HDMI source signals for output to a connected DVI display.
- **Automatic input cable equalization to 50 feet at 4K/30 and 100 feet at 1080p60 with 8-bit color when used with Extron HDMI Pro Series cable** — Actively conditions incoming HDMI signals to compensate for signal loss when using long cables, low quality cables, or source devices with poor signal output.
- **Front panel USB configuration port**
- **Easy setup and commissioning with Extron's PCS – Product Configuration Software** — Conveniently configure multiple products using a single software application.
- **Provides +5 VDC, 250 mA power on the output for external peripheral devices**
- **Includes LockIt HDMI cable lacing brackets**
- **Energy-efficient external universal power supply included** — Provides worldwide compatibility, low power consumption, and reduced operating costs.

Application Diagram

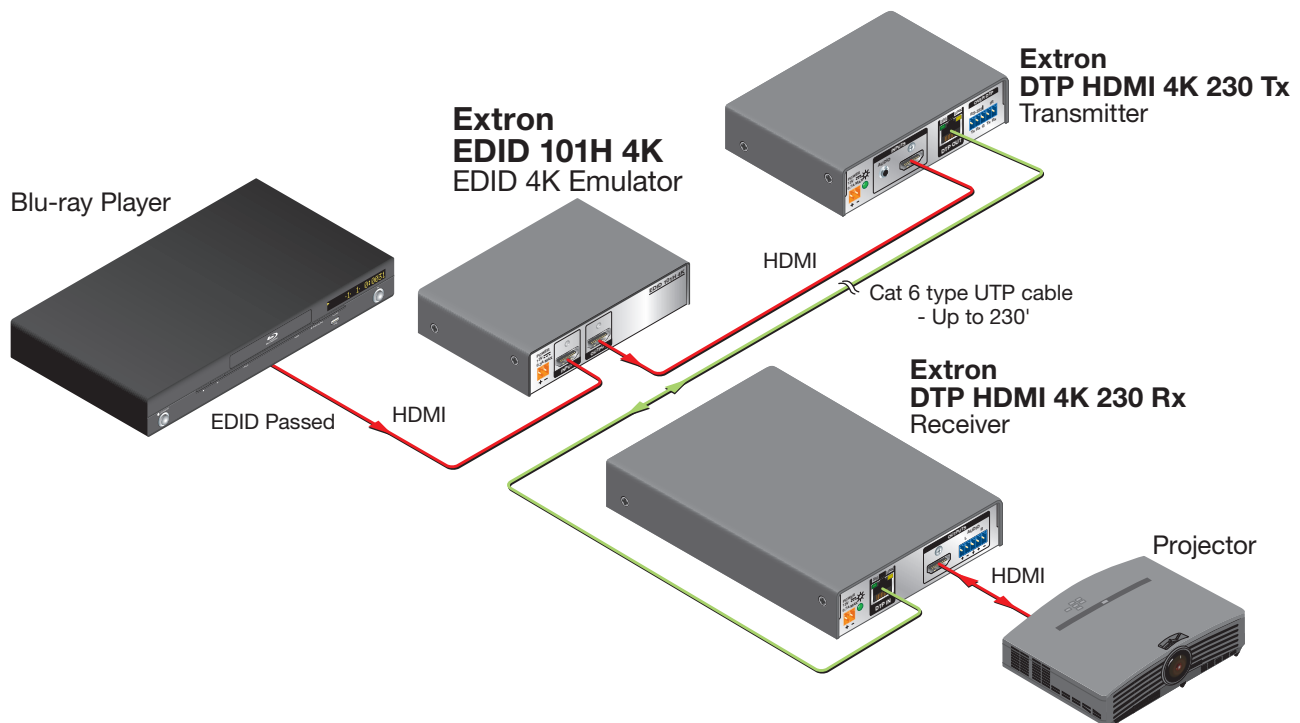

Figure 1. EDID 101H 4K Application Diagram

Installation and Configuration

This section describes the installation, and configuration of the EDID 101H 4K, including:

- [Installation Overview](#)
- [Front Panel Features](#)
- [Rear Panel Features and Cabling](#)
- [HDMI Connector LockIt Lacing Bracket](#)
- [EDID Configuration](#)

Installation Overview

To install the EDID 101H 4K:

1. Mount the EDID 101H 4K (see [Mounting the EDID 101H 4K](#) on page 21). Do not connect power to the source, the display, or the EDID 101H 4K at this time.

TIP: Configure the EDID 101H 4K prior to the installation, if access is restricted after mounting or installation.

3. Configure the EDID 101H 4K (see [EDID Configuration](#) on page 7).
4. Connect an HDMI cable from the source to the input connector (see [Rear Panel Features and Cabling](#), **B** on page 5).
5. Connect an HDMI cable from the output connector (**C**) to the video display or distribution system input.
6. Connect power and turn on the video display or distribution system.
7. Apply power to the EDID 101H 4K (**A**). The power LED lights.
8. Turn on the video source.

The video source reads the EDID information from the EDID 101H 4K.

Front Panel Features

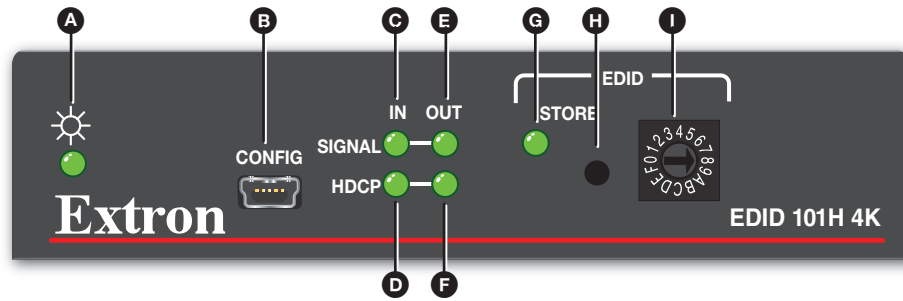

Figure 2. EDID 101H 4K Front Panel Indicators and Configuration Port

- A Power LED** – Lights when an external power supply is connected and powered.
- B Config port** – Connect a host computer using a USB mini-B connector for configuration using SIS commands or the PCS configuration software, and for firmware updates (see [Connecting to the USB Port](#) on page 22).
- C Signal In LED** – Lights when an HDMI signal is detected on the input.
- D HDCP In LED** – Lights when the source device requires HDCP encryption and the signal has been authenticated.
- E Signal Out LED** – Lights when an active sink (display) device is connected to the output.
- F HDCP Out LED** – Lights when HDCP is authenticated between the HDMI output and the connected sink device. This occurs only when the source device requires HDCP and is authenticated.

If the source does not require HDCP or if the sink device is not HDCP compliant, the LED does not light.
- G EDID Store LED** – Lights steadily when power is connected. It blinks when the unit is reading and storing EDID from a connected output device, returning to steady when recording is complete.
- H EDID Store button** – Press this recessed button to initiate reading and storing an EDID. The EDID is stored to a user slot selected by the rotary switch (**I**). Up to three EDID files can be stored.

Reset – To reset the EDID 101H 4K to its default state, press and hold the **EDID STORE** button while applying power. As power is applied, all front panel LEDs blink 3 times indicating a successful reset.
- I EDID selection rotary switch** – One 16-position rotary switch provides a choice of 15 user stored and pre-programmed EDID files (see [EDID Configuration](#) on page 7), and one EDID read from a connected display.

Rear Panel Features and Cabling

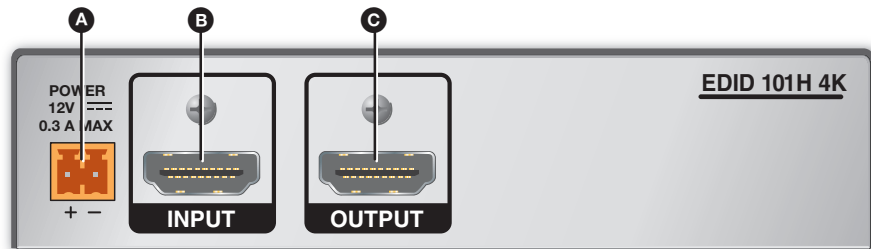

Figure 3. EDID 101H 4K Rear Panel

A Power connector (see [Power Connector](#) on page 6)

B HDMI input – Connect an HDMI source to this female HDMI connector.
HDCP – When required, the HDMI input negotiates and authenticates HDCP with a source device. The authentication process is repeated when a stored EDID is changed.

C HDMI output – Connect a display or other output device to this female HDMI connector. The HDMI output provides +5 VDC, (up to 250 mA with over-current protection) on pin 16.

HDCP – If a connected output device requires HDCP encryption, the output negotiates and authenticates HDCP directly.

Video Format Correction – When the current input signal is HDMI and the connected output is DVI, the signal is converted to DVI format. This is based on the capability of the connected output device as listed in its EDID.

The EDID information is read from the connected output device and written to memory whenever the output device is connected to this port and powered on.

NOTE: The EDID information is also read and stored whenever power is recycled to the connected output device or when the output device is replaced.

- A Power Connector** – Connect the included 12 VDC power supply to this two-pole, 3.5 mm captive screw connector.

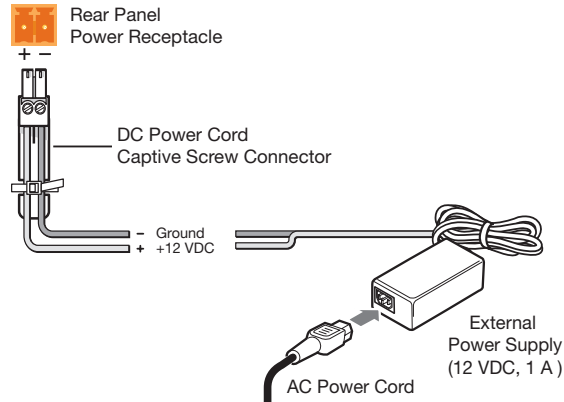

Figure 4. 12 VDC Power Connection to EDID 101H 4K

ATTENTION:

- Always use a power supply provided by or specified by Extron. Use of an unauthorized power supply voids all regulatory compliance certification and may cause damage to the supply and the end product.
- Utilisez toujours une source d'alimentation fournie ou recommandée par Extron. L'utilisation d'une source d'alimentation non autorisée annule toute conformité réglementaire et peut endommager la source d'alimentation ainsi que le produit final.
- Unless otherwise stated, the AC/DC adapters are not suitable for use in air handling spaces or in wall cavities.
- Sauf mention contraire, les adaptateurs AC/DC ne sont pas appropriés pour une utilisation dans les espaces d'aération ou dans les cavités murales.
- The power supply is to be located within the same vicinity as the Extron AV processing equipment in an ordinary location, Pollution Degree 2, secured to the equipment rack within the dedicated closet, podium, or desk.
- La source d'alimentation doit être située à proximité de l'équipement de traitement audiovisuel dans un endroit ordinaire, avec un degré 2 de pollution, fixé à un équipement de rack à l'intérieur d'un placard, d'une estrade, ou d'un bureau.
- The installation must always be in accordance with the applicable provisions of National Electrical Code ANSI/NFPA 70, article 75 and the Canadian Electrical Code part 1, section 16.
- Cette installation doit toujours être en accord avec les mesures qui s'applique au National Electrical Code ANSI/NFPA 70, article 725, et au Canadian Electrical Code, partie 1, section 16.
- The power supply shall not be permanently fixed to building structure or similar structure.
- La source d'alimentation ne devra pas être fixée de façon permanente à une structure de bâtiment ou à une structure similaire.
- If not provided with a power supply, this product is intended to be supplied by a power source marked "Class 2" or "LPS" and rated at 12 VDC and a minimum of 0.3 A.
- Si ce produit ne dispose pas de sa propre source d'alimentation électrique, il doit être alimenté par une source d'alimentation de classe 2 ou LPS et paramétré à 12 V et 0.3 A minimum.

HDMI Connector LockIt Lacing Bracket

Use an Extron LockIt Lacing Bracket to secure HDMI cables to the device.

1. Plug the HDMI cable into the rear panel connection (see figure 5, **1**).

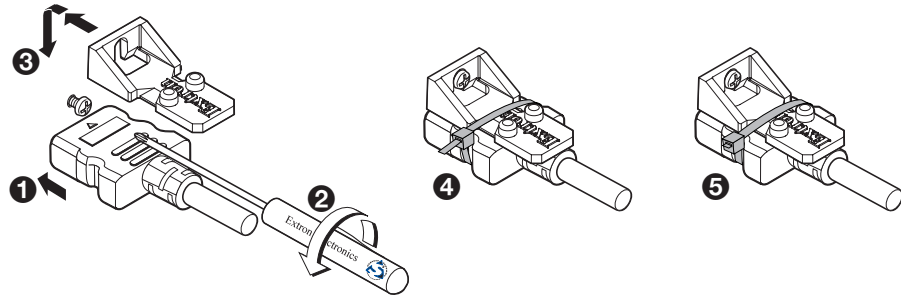

Figure 5. Installing the HDMI LockIt Lacing Bracket

2. Loosen the HDMI connection mounting screw from the panel enough to allow the LockIt lacing bracket to be placed over it (**2**). The screw does not have to be removed.
3. Place the LockIt Lacing Bracket on the screw and against the HDMI connector (see figure 5, **3** on the previous page), then tighten the screw to secure the bracket.

ATTENTION:

- Do not overtighten the HDMI connector mounting screw. The shield to which it is fastened is very thin and can easily be stripped.
- Ne serrez pas trop la vis de montage du connecteur HDMI. Le blindage auquel elle est attachée est très fin et peut facilement être dénudé.

4. Loosely place the included tie wrap around the HDMI connector and the LockIt Lacing Bracket as shown (**4**).
5. Hold the connector securely against the lacing bracket, tighten the tie wrap, then remove the excess length (**5**).

EDID Configuration

EDID Minder ensures that a connected source has access to the EDID of a display, even if the display is not connected. Depending on the EDID mode selected, the EDID of a connected display or custom EDID can be stored in one of three user slots, or the user can manually select an EDID from the table of Extron factory EDID (see [figure 7](#) on page 8).

TIP: If access to the EDID 101H 4K is restricted after mounting and connection, configure it prior to the installation.

Assign Extron Factory EDID

Rotary switch positions 0 through B are Extron factory EDID. Select a switch position corresponding to the desired resolution (see [figure 7](#) on page 8).

Additionally, three user slots (D, E, and F) are available to save the EDID of connected displays (see [Store an EDID in a User Slot](#) on page 8) and to import EDID files from an external source with PCS (see [Using the Software and Device Menus](#) on page 15). EDID saved to these slots are retained after a power cycle. Upon a factory reset, these EDID slots revert to the default (720p @ 60 Hz, 2-Ch audio).

Store an EDID in a User Slot

To record EDID from a connected display:

1. Turn the rotary switch (see figure 6, **3**) to the desired user slot location (D through F).
2. Connect the display device to the output connector of the EDID 101H 4K (see figure 3 **C** on page 5).
3. Connect a power source and apply power to the EDID 101H 4K (**A**). The power LED lights steady when power is available.
4. Power on the display device.
5. Press **STORE** (see figure 6, **2**) once to store the display EDID to the memory slot selected in step 1. The LED (**1**) blinks. When the LED returns to solid, the EDID is stored.

NOTE: EDID stored in user slots D through F are saved until a new EDID is stored to that slot or the device is reset.

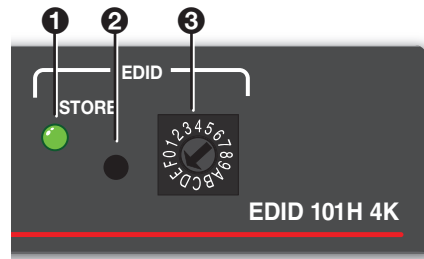

Figure 6. Store LED, Button and Rotary Switch (in Position E)

Rotary Position	Resolution	Refresh (Hz)	Audio	EDID Table x6
0	1280x800	60	2-Ch	1
1	1440x900	60	2-Ch	2
2	1600x900	60	2-Ch	3
3	1680x1050	60	2-Ch	4
4	1920x1200	60	2-Ch	5
5	2560x1440	60	2-Ch	6
6	2560x1600	60	2-Ch	7
7	720p	50	2-Ch	8
*8	720p	60	2-Ch	9
9	1080p	50	2-Ch	10
A	1080p	60	2-Ch	11
B	4K/UHD	30	2-Ch	12
C	Output	Automatically populated with the connected display EDID		13
D	User Slot 1			14
E	User Slot 2			15
F	User Slot 3			16

Figure 7. Rotary Switch Position EDID Selection

LED	Rotary Switch	Store Button	Description
Off	0-C	Non-functional	EDID storing is not possible on the selected rotary switch position.
Steady	D-F	N/A	EDID storing is possible on the selected rotary position, or following a blinking state, the storing process is complete.
Blinking	D-F	Button pressed and released	After the Store button is pressed, the EDID is written to the user slot selected by the rotary switch. When the EDID is stored, the LED lights steadily.

Figure 8. EDID Store LED

EDID Assignment Via SIS Commands

The EDID assignment can be configured via SIS commands (see [Using the Command and Response Table](#) on page 17). SIS commands can store EDID information only to user slots D, E, and F. The EDID slots are locked to the factory EDID data for positions 0 to C.

The EDID table reference for the SIS commands (see [figure 7](#) on page 8) is labelled **x6** for consistency with the SIS command.

Configuration Software

The Extron Product Configuration Software (PCS) offers another way to configure the EDID 101H 4K via USB in addition to the SIS commands.

This section describes the software installation and communication. Topics in this section include:

- [Downloading Software from the Extron Website](#)
- [Installing the Software](#)
- [Starting the Software](#)
- [Using the Software and Device Menus](#)

The graphical interface includes the same functions as those on the device front panel with additional features that are available only using the software.

The control software is compatible with Microsoft Windows operating systems. The software program is available on the Extron [website](#).

Downloading Software from the Extron Website

Visit www.extron.com to find the latest versions of software and firmware for your product. If necessary, before updating firmware, download and install Firmware Loader.

Download and install the PCS software for configuring the EDID 101H 4K.

1. Click the **Download** tab (see figure 9, ❶).

The Download Center opens.



Figure 9. Software and Firmware Links on the Download Tab

2. On the **Download Home** sidebar menu, on the left side, click the appropriate link:
 - If the software is listed in the sidebar, click directly on that link (for example, see the **PCS** link example (2) in figure 9 on the previous page).
 - If the software is not in the sidebar, click the **Software** link at the top of the sidebar (see figure 9, 3 on the previous page) to open the software library.
 - If there is no direct link to your software, an alphabetic navigation bar is provided at the top or bottom of the download pages (see figure 10). Click the appropriate letter to locate the software or firmware.



Figure 10. Alphabetic Navigation Bar

3. Click **Release Notes** to see the issues that have been addressed by the latest update.
4. Click **Download** and follow the **Installation Wizard** instructions to install the software on your computer.

Installing the Software

The Extron **Product Configuration Software (PCS)** must be downloaded from the Extron website to configure the EDID 101H 4K. To download PCS:

1. On the Extron website, select the **Download** tab (see figure 11, 1).

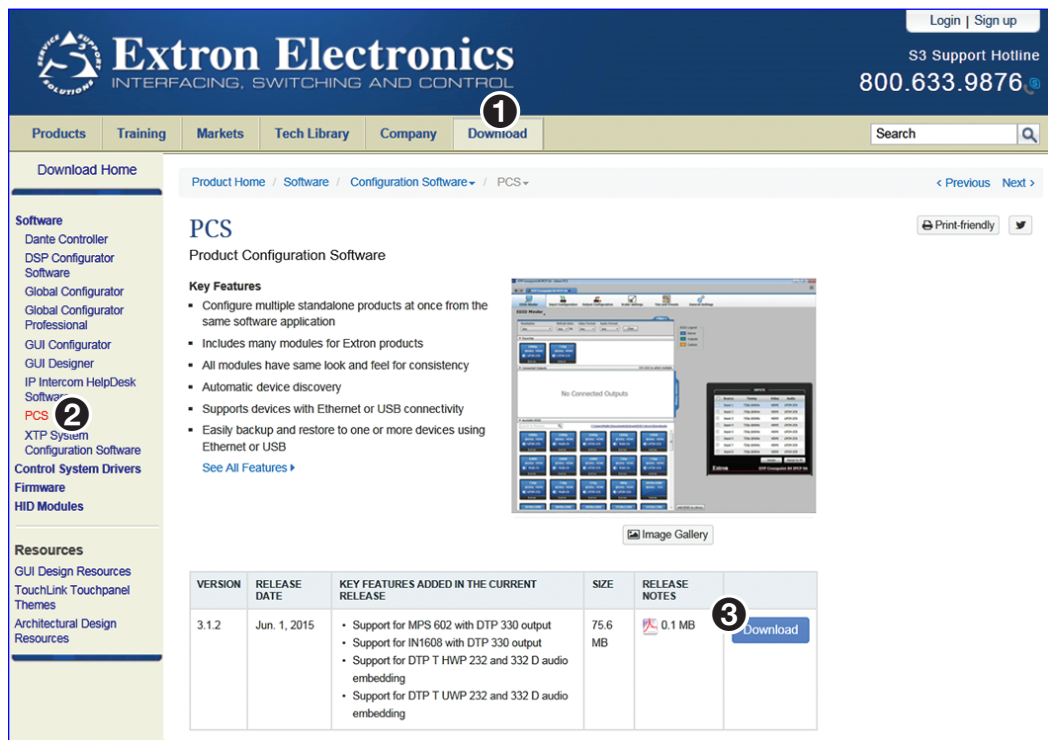

Figure 11. PCS Download from the Extron Website

- From the left sidebar on the **Download** page, click the **PCS** link (see figure 11, ② on the previous page).

The PCS page opens (see figure 12).

Product Home / Software / Configuration Software ▾ / PCS ▾ < Previous Next >

PCS

Product Configuration Software

Print-friendly

Key Features

- Configure multiple standalone products at once from the same software application
- Includes many modules for Extron products
- All modules have same look and feel for consistency
- Automatic device discovery
- Supports devices with Ethernet or USB connectivity
- Easily backup and restore to one or more devices using Ethernet or USB

[See All Features ▶](#)

Image Gallery

VERSION	RELEASE DATE	NEW IN THE CURRENT RELEASE	SIZE	RELEASE NOTES
3.5.0	Apr. 12, 2016	<ul style="list-style-type: none"> Support for DTP T USW 233 Support for DTP T USW 333 Support for DTP CrossPoint 82 4K Series Support for DTP CrossPoint 84 4K Series Support for PVS 407D 	102.3 MB	0.2 MB 1 Download Login required

Figure 12. PCS Download Page

- On the PCS page, click **Download** (①).
- Submit the required information to start the download. Note where the file is saved.
- Open the executable (**.exe**) file from the save location.
- Follow the onscreen instructions. By default, the installation creates a directory in the **Program Files** or **Program Files (x86)** folder.

Starting the Software

Open the **Extron Product Configuration** software program from the **Start** menu or desktop shortcut. PCS opens to the **Device Discovery** page.

NOTES:

- PCS versions prior to 2.0 do not have the **Device Discovery** feature. Download the latest version of PCS (see [Installing the Software](#) on page 11).
- The EDID 101H 4K supports USB connection only. However, all devices located and supported by PCS are listed in the **Device Discovery** panel (see figure 14).

Device Discovery Panel

When the PC running PCS is connected to Extron devices via USB and is also connected to a LAN or WAN, the **Device Discovery** panel lists all PCS compatible devices. Devices can be identified and sorted by Model, IP address, Device Name, or Connection method.

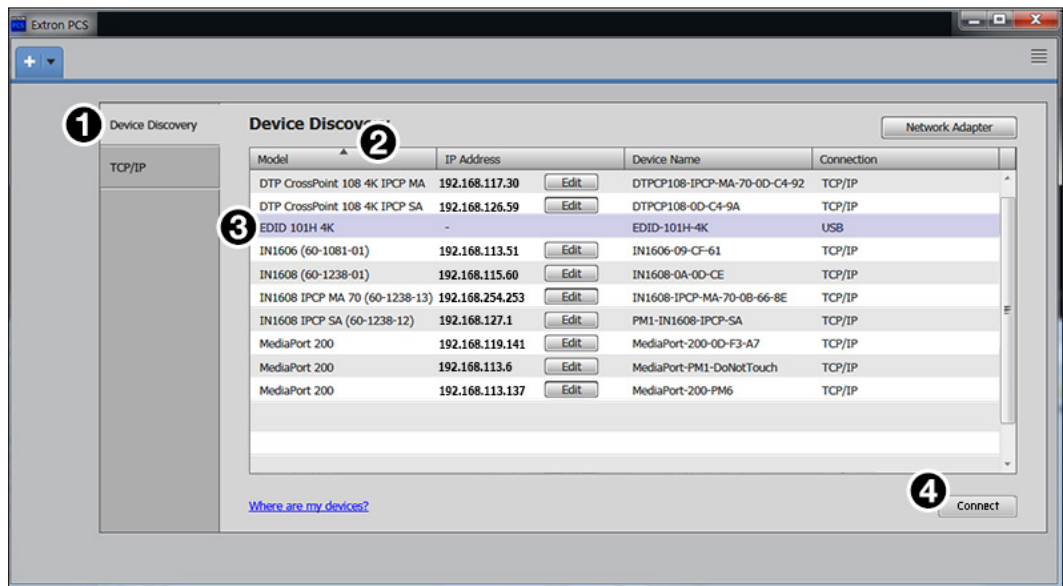

Figure 13. Device Discovery Panel

To sort the list of available devices:

1. Click the **Device Discovery** tab (see figure 13, ❶).
2. Click the desired column heading (❷) to sort the desired category (**Model**, **IP Address**, **Device Name** and **Connection**) in ascending or descending order.

To connect to a device:

1. Click the **Device Discovery** tab (❶).
2. Double-click the EDID 101H row (❸). A new device configuration tab opens (see [figure 14](#) on page 14).

or

1. Click the **Device Discovery** tab (❶).
2. Single-click the row (❸) to highlight it.
3. Click **Connect** (❹). A new device configuration tab opens (see [figure 14](#) on page 14).

Help Files

When the device page opens, two help files are available; one for the PCS program (see figure 14, ②), and another for the EDID 101H 4K (④).

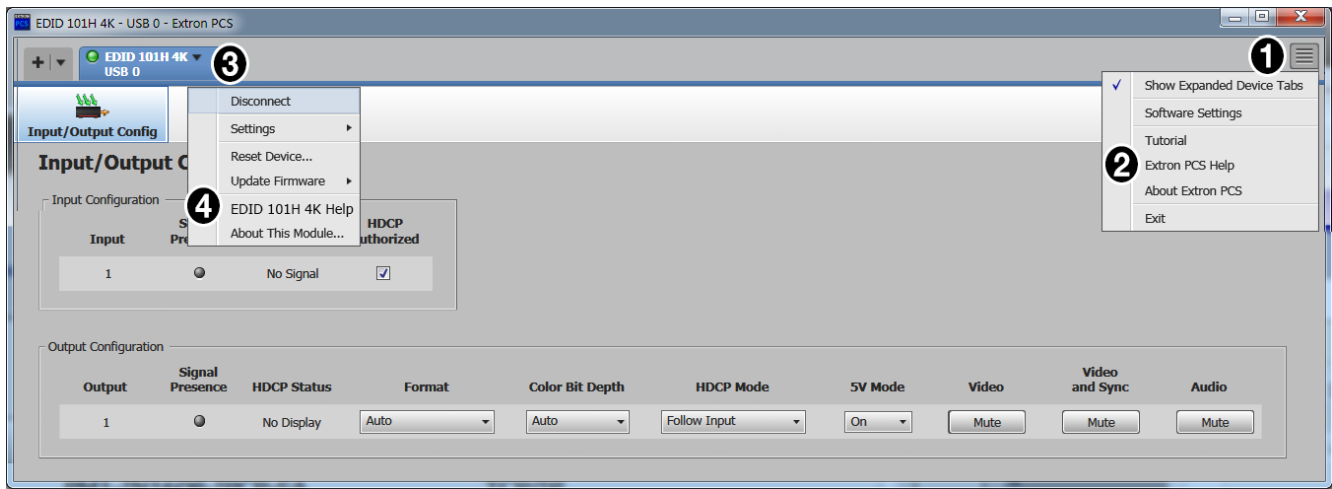



Figure 14. PCS and Device Specific Help Files

Click the hidden menu icon () to access a drop-down list (see figure 14, ①), then click **Extron PCS Help** to open the help file (②). The PCS Help file assists with PCS software operation.

Click the **Device** tab (③), then click **EDID 101H 4K Help** (④) to access the EDID 101H 4K help file for assistance with the device user interface.

Offline Device Preview

The EDID 101H 4K configuration options can be viewed without connecting to a device, but settings cannot be changed or saved.

To open a device tab:

1. In the **Start-up** tab drop-down list, select **New Configuration File** (see figure 15).

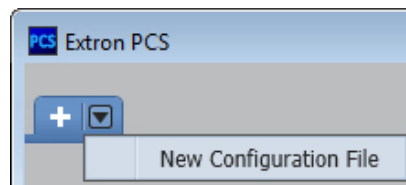

Figure 15. Configuration Drop-down List

The New Configuration File dialog box opens (see figure 16).

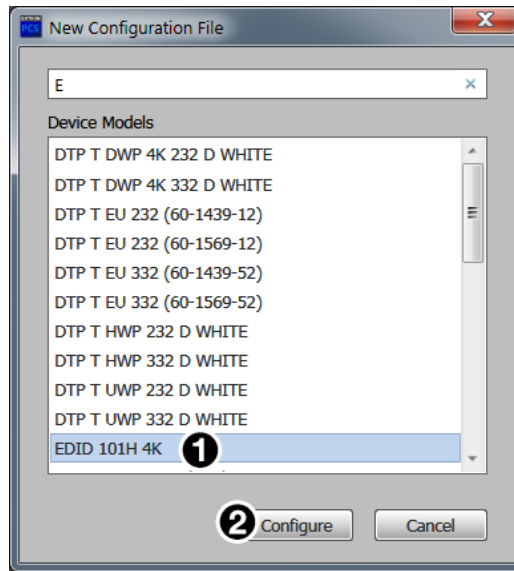

Figure 16. New Configuration File (EDID 101H 4K Selected)

2. Select the desired device model from the Device Models list (1).
3. Click **Configure** (2). A new offline device configuration tab opens.

See the *EDID 101H 4K Help* file (see [Help Files](#) on page 14) for descriptions of the configuration options.

Using the Software and Device Menus

The PCS software provides configuration and operation of the connected device from a control device. Access the *PCS Software Help* file or the *EDID 101H 4K Help* file for further information.

Remote Communication and Control

This section describes remote operation of the EDID 101H 4K. Topics include:

- [Using Simple Instruction Set \(SIS\) Commands](#)
- [Command and Response Table for SIS Commands](#)

Using Simple Instruction Set (SIS) Commands

The EDID 101H 4K is remotely set up and controlled using Extron SIS commands issued from a host computer or other device, such as a control system. SIS commands are issued from the connected computer to the front panel **Config** port (see [Connecting to the USB Port](#) on page 22 to connect to this port).

Host-to-device Communications

SIS commands consist of one or more characters per field. No special characters are required to begin or end a command sequence. You can enter these commands from your computer using a communication software program such as Extron DataViewer. When the device determines that a command is valid, it executes the command and sends a response to the host device.

Most responses from the EDID 101H 4K to the host computer end with a carriage return and a line feed (CR/LF = ) , which signals the end of the response character string. A string is one or more characters.

Device-initiated Messages

When a local event such as a change in input signal or HDCP status, or a change in the EDID assignment (changing the front panel rotary switch) takes place, the device responds by sending a message to the host, indicating the change. No response is required from the host.

Error Responses

If the device is unable to execute a command it receives because the command is invalid or contains invalid parameters, the device returns an error response to the host. The following error response codes can be sent:

- E10 – Invalid command
- E13 – Invalid value (out of range)
- E14 – Not valid for this configuration

Using the Command and Response Table

The command and response table is shown on the following pages. Symbols are used throughout the table to represent variables in the command and response fields. Symbol definitions and an ASCII-to-hexadecimal (HEX) conversion table are shown below. Command and response examples are shown throughout the command and response table.

NOTE: Upper and lower case text can be used interchangeably unless otherwise stated.

ASCII to HEX Conversion Table										Esc 1B	CR 0D	LF 0A		
Space 20	!	21	"	22	#	23	\$	24	%	25	&	26	'	27
(28)	29	*	2A	+	2B	,	2C	-	2D	·	2E	/	2F
0 30	1	31	2	32	3	33	4	34	5	35	6	36	7	37
8 38	9	39	:	3A	;	3B	<	3C	=	3D	>	3E	?	3F
@ 40	A	41	B	42	C	43	D	44	E	45	F	46	G	47
H 48	I	49	J	4A	K	4B	L	4C	M	4D	N	4E	O	4F
P 50	Q	51	R	52	S	53	T	54	U	55	V	56	W	57
X 58	Y	59	Z	5A	[5B	\	5C]	5D	^	5E	_	5F
` 60	a	61	b	62	c	63	d	64	e	65	f	66	g	67
h 68	i	69	j	6A	k	6B	l	6C	m	6D	n	6E	o	6F
p 70	q	71	r	72	s	73	t	74	u	75	v	76	w	77
x 78	y	79	z	7A	{	7B		7C	}	7D	~	7E	DEL	7F

Figure 17. ASCII to Hex Conversion Table

Symbol Definitions

- ↵ = CR/LF (carriage return with line feed) (hex 0D 0A)
- ← = Soft carriage return (no line feed)
- = Space character for a command or response. Other spaces in these tables are for clarity only.
- W = Alternate for <Esc>
- | = (pipe symbol) is an alternative to ←
- Esc** = Escape
- X2** = Video mute:
 - 0 = Off, unmuted (default)
 - 1 = On, video muted
 - 2 = Video and Sync muted
- X3** = Status
 - 0 = Off, disabled, or undetected
 - 1 = On, enabled, or detected
- X4** = Output HDCP Mode:
 - 0 = Encrypt as required by input. Continuous trials for HDMI sinks, attempt for 10s on DVI sinks (then fail) (Default)
 - 1 = Always encrypt. Continuous trials for HDMI sinks, attempt for 10s on DVI sinks (then fail).
 - 2 = Encrypt as required by input. Continuous trials for HDMI and DVI sinks.
 - 3 = Always encrypt. Continuous trials for HDMI and DVI sinks.
- X5** = Output TMDS Format:
 - 0 = Auto (default), HDMI RGB Full if HDMI sink, force DVI format if DVI sink.
 - 1 = DVI RGB 444 Full
 - 2 = HDMI RGB 444 Full
 - 3 = HDMI RGB 444 Limited
 - 4 = HDMI YUV 444 Limited
 - 5 = HDMI YUV 422 Limited
- X6** = The EDID memory slot location from EDID table (see [figure 7](#) on page 8).
 - 0 through B (1-12) = factory assigned slots
 - D through F (14-16) = user assigned slots.
- X7** = 128 or 256 Bytes of raw hex data (text representation) from currently assigned EDID.
- X8** = Native resolution and refresh rate from currently assigned EDID.
Ex: 1920x1080@60Hz
- X9** = Output color bit depth: 0= auto based on sink EDID (default), 1= force 8-bit/color
- X10** = Verbose mode:
 - 0=none
 - 1=verbose mode (default)
 - 2=tagged responses for queries
 - 3=verbose mode and tagged responses for queries.
- X11** = Unit name. The name can have up to 24 alphanumeric characters including hyphens (-), with no spaces. The first character must be a letter, and the last character cannot be a hyphen. The default is **EDID-101H 4K**.
- X12** = Input HDCP status:
 - 0 = No active video source detected
 - 1 = Video detected without HDCP (not encrypted)
 - 2 = Video detected with HDCP (encrypted)
- X13** = Output HDCP status:
 - 0 = No sink detected
 - 1 = Non-HDCP sink detected
 - 2 = HDCP sink detected not encrypted
 - 3 = HDCP sink detected and encrypted
- X14** = Output 5V mode:
 - 0 = Auto (5V enabled when source with 5V present, else off)
 - 1 = 5V always enabled (default).

Command and Response Table for SIS Commands

Command	ASCII Command (Host to Device)	Response (Device to Host)	Additional Description
Signal Status (corresponds to the front panel LED indicators)			
Input/Output signal status	[Esc] ØLS ←	[X3] * [X3] ← Sig [X3] * [X3] ←	Verbose mode 1 Input * output
Input HDCP status	[Esc] I HDCP ←	HdcpI [X12] ←	
Output HDCP status	[Esc] O HDCP ←	HdcpO [X13] ←	
Video			
Video mute	[X2] B	Vmt [X2] ←	
View video mute status	B	[X2] ←	
Input HDCP authorization	[Esc] E [X3] HDCP ←	HdcpE [X3] ←	
HDCP authorization status	[Esc] E HDCP ←	HdcpE [X3] ←	
Output HDCP mode	[Esc] S [X4] HDCP ←	HdcpS [X4] ←	
Output HDCP mode status	[Esc] S HDCP ←	HdcpS [X4] ←	
Output TMDS format	[Esc] [X5] VTPO ←	Vtpo [X5] ←	
Output TMDS format status	[Esc] VTPO ←	Vtpo [X5] ←	
Output color depth	[Esc] V [X9] BITD ←	BitdV [X9] ←	
Output color depth status	[Esc] V BITD ←	BitdV [X9] ←	
Set Output hot-plug mode	[Esc] M [X14] HPLG ←	HplgM [X14] ←	
Output hot-plug mode status	[Esc] M HPLG ←	HplgM [X14] ←	
Audio			
Audio mute	[X3] Z	Amt [X3] ←	Mute and unmute the audio signal.
View audio mute status	Z	Amt [X3] ←	
EDID Minder			
View native EDID resolution	[Esc] N EDID ←	[X8] ←	Show native resolution and refresh rate [X8] from current EDID selection.. Example: 1600x1200 @ 60 Hz ←
View EDID assignment	[Esc] A EDID ←	EdidA [X6] ←	1-16 (see figure 7 on page 8).
View EDID in hex format	[Esc] R EDID ←	[X7] ←	
Import EDID to specified user slot	[Esc] S [X6] EDID ←	EdidS [X6] ←	Store the EDID of the connected display as user-assigned EDID file [X6] . [X6] = 14 through 16
Device Name			
Set device name	[Esc] [X11] CN ←	Ipn • [X11] ←	
Set name to default	[Esc] • CN ←	Ipn • EDID-101H-4K ←	
View unit name	[Esc] CN ←	Ipn • [X11] ←	
Information Requests			
Request part number	N	Pno60-1543-01 ←	The part number of the device.
Request model name	1 I	Inf01 * [X11] ←	
Request model description	2 I	Inf02 * EDID • Emulator • for • HDMI ←	
Request firmware version	Q	x.xx ←	Show firmware number expressed to the second decimal place.
Request firmware version and build number	*Q	x.xx.xxxx ←	Show firmware number and build number.

Command	ASCII Command (Host to Device)	Response (Device to Host)	Additional Description
Resetting			
Initiate reset	[Esc] ZXXX ←	Zpx ↵	Reset the device to its factory default values.
Verbose mode			
Set Verbose mode	[Esc] [X10]CV ←	Vrb[X10] ↵	Verbose mode 2/3
View verbose mode status	[Esc] CV ←	[X10] ↵ Vrb[X10] ↵	Verbose mode 1 Verbose mode 2/3

NOTE: Responses shown in Verbose mode 2/3 unless otherwise stated.

Reference Information

- [Mounting the EDID 101H 4K](#)
- [Connecting to the USB Port](#)
- [DataViewer](#)
- [Updating the Firmware](#)

Mounting the EDID 101H 4K

The 1-inch high, quarter-rack width, 6-inch deep enclosure can be

- Set on a table,
- Mounted on a rack shelf,
- Mounted under a desk or table-top.

Desktop Placement

Attach the four provided rubber feet to the bottom of the EDID 101H 4K and place it in any convenient location.

Rack Mounting

UL Guidelines for Rack Mounting

The following Underwriters Laboratories (UL) guidelines are relevant to the safe installation of these products in a rack:

Elevated operating ambient temperature — If the units are installed in a closed or multiunit rack assembly, the operating ambient temperature of the rack environment may be greater than room ambient temperature. Therefore, install the equipment in an environment compatible with the maximum ambient temperature (T_{ma}: +122 °F, +50 °C) specified by Extron.

Reduced air flow — Install the equipment in the rack so that the equipment gets adequate air flow for safe operation.

Mechanical loading — Mount the equipment in the rack so that uneven mechanical loading does not create a hazardous condition.

Circuit overloading — Connect the equipment to the supply circuit and consider the effect that circuit overloading might have on overcurrent protection and supply wiring. Consider the equipment nameplate ratings when addressing this concern.

Reliable earthing (grounding) — Maintain reliable grounding of rack-mounted equipment. Pay particular attention to supply connections other than direct connections to the branch circuit (such as the use of power strips).

Rack Mounting Procedure

To mount the unit on a rack shelf, follow the instructions provided with the shelf accessories.

Connecting to the USB Port

A mini type- B USB Config port located on the front panel (see [Front Panel Features](#) on page 4) is used to connect to a host computer for configuration using SIS commands with Extron DataViewer, for updating firmware with the Extron Firmware Loader utility and for using PCS. DataViewer and Firmware Loader are available at www.extron.com. The programs are also necessary to install the USB driver to the connected computer.

To connect the EDID 101H 4K to a host computer:

NOTES:

- If an Extron USB device has never been connected to the host computer, prior to connecting the Config (USB) port for the first time, you must install and activate the USB driver. The simplest way to do this is to install either Dataviewer (see [DataViewer](#) on page 24) or the Firmware Loader utility (see [Updating the Firmware](#) on page 25).
 - The wizard opens only on the first occasion you connect the EDID 101H 4K to that USB port. The wizard reopens if you connect the EDID 101H 4K to a different USB port or if you connect a different piece of equipment, requiring a different driver, to the same USB port.
1. Connect a USB A to mini B cable between the **Config** port on the front panel of the EDID 101H 4K and a USB port of the PC (see figure 18).

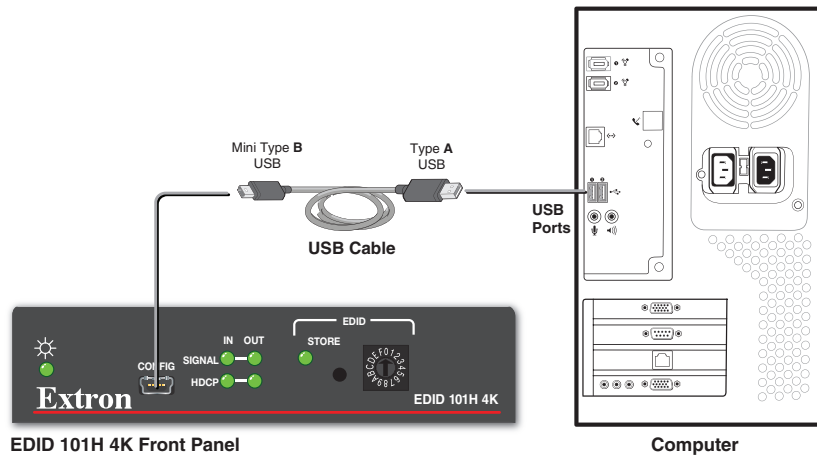

Figure 18. Connecting a PC to the Front Panel USB Port

If this is the first time an EDID 101H 4K is connected to the PC, the Found New Hardware Wizard opens (see figure 19).

2. Select **No, not this time** (1).



Figure 19. Found New Hardware Wizard Welcome Screen

3. Click **Next** (2).

The following dialog box opens:

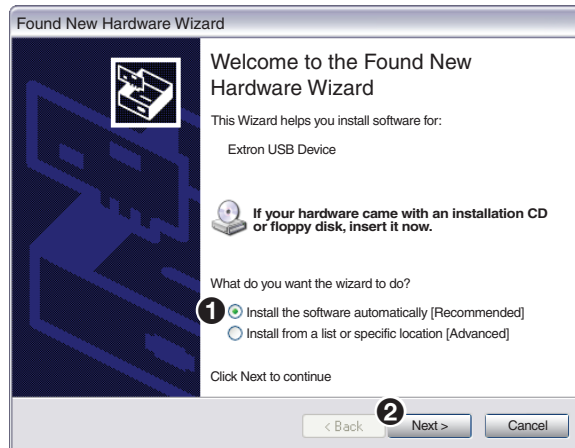

Figure 20. Installing the Software Automatically

4. Select **Install the software automatically (Recommended)** (see figure 20, 1).

NOTE: You do not need to insert an installation disc.

5. Click **Next** (2).

The PC locates the required driver and installs it in the correct location on the hard drive.

6. When the **Completed** dialog opens, click **Finish** to close the wizard.

NOTE: The wizard opens only on the first occasion you connect the EDID 101H 4K to a USB port. The wizard reopens if you connect it to a different USB port or if you connect a different piece of equipment, requiring a different driver, to the same USB port.

7. Configure the EDID 101H 4K as required (see **Remote Communication and Control** on page 16).

DataViewer

DataViewer is an enhanced terminal emulation program that facilitates analysis of RS-232, USB, and TCP/IP communication with Extron devices. The software allows users to send commands to a device and view the responses in ASCII or hexadecimal format. Command and response logs can be saved in text or HTML format.

DataViewer is available at www.extron.com. Enter **DataViewer** in the search engine to locate the program.

Download the installation file and load the program on the PC connected to the EDID 101H 4K.

NOTES:

- Only the USB tab is available for the EDID 101H 4K.
- If an Extron USB device has never been connected to the host computer, after installing DataViewer, you must then install and activate the USB driver (see [Connecting to the USB Port](#) on page 22).

To run DataViewer:

1. Click the DataViewer desktop icon.
2. The **Communications Setup** dialog box opens (see the figure at right). Select the **USB** tab (1).
3. From the **USB Port** drop-down list, select **Extron USB Device 0** (2).
4. Select the startup option.
To automatically connect to the EDID 101H 4K, click **Connect on Startup** (3).
5. Click **OK** (4) to start using the program.

You are now ready to begin entering commands.

Use the DataViewer help file for more information on the program.

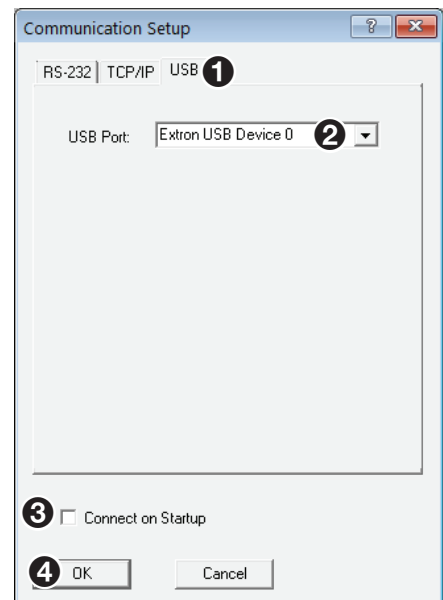

Updating the Firmware

Firmware updates are released periodically on the Extron website. You can find the version currently loaded on your device using SIS commands (see [Command and Response Table for SIS Commands](#) on page 19). Compare this with the latest release for the EDID 101H 4K on the Extron website and decide whether to update your firmware.

TIP: Read the Release Notes provided on the website with the latest firmware to determine whether you need the latest version.

This section describes how to update firmware for the EDID 101H 4K including:

- [Download and Install Firmware Loader](#)
- [Downloading EDID 101H 4K Firmware](#)
- [Loading EDID 101H 4K Firmware](#)

Download and Install Firmware Loader

Use the Extron Firmware Loader utility to update the firmware on Extron products. If you do not already have Firmware Loader installed on your computer, download it as follows:

1. Go to the Extron website at www.extron.com.
2. In the **Search** field, enter **Firmware Loader** and press <Enter> (see figure 21, ①)

The **Firmware Loader** page opens.

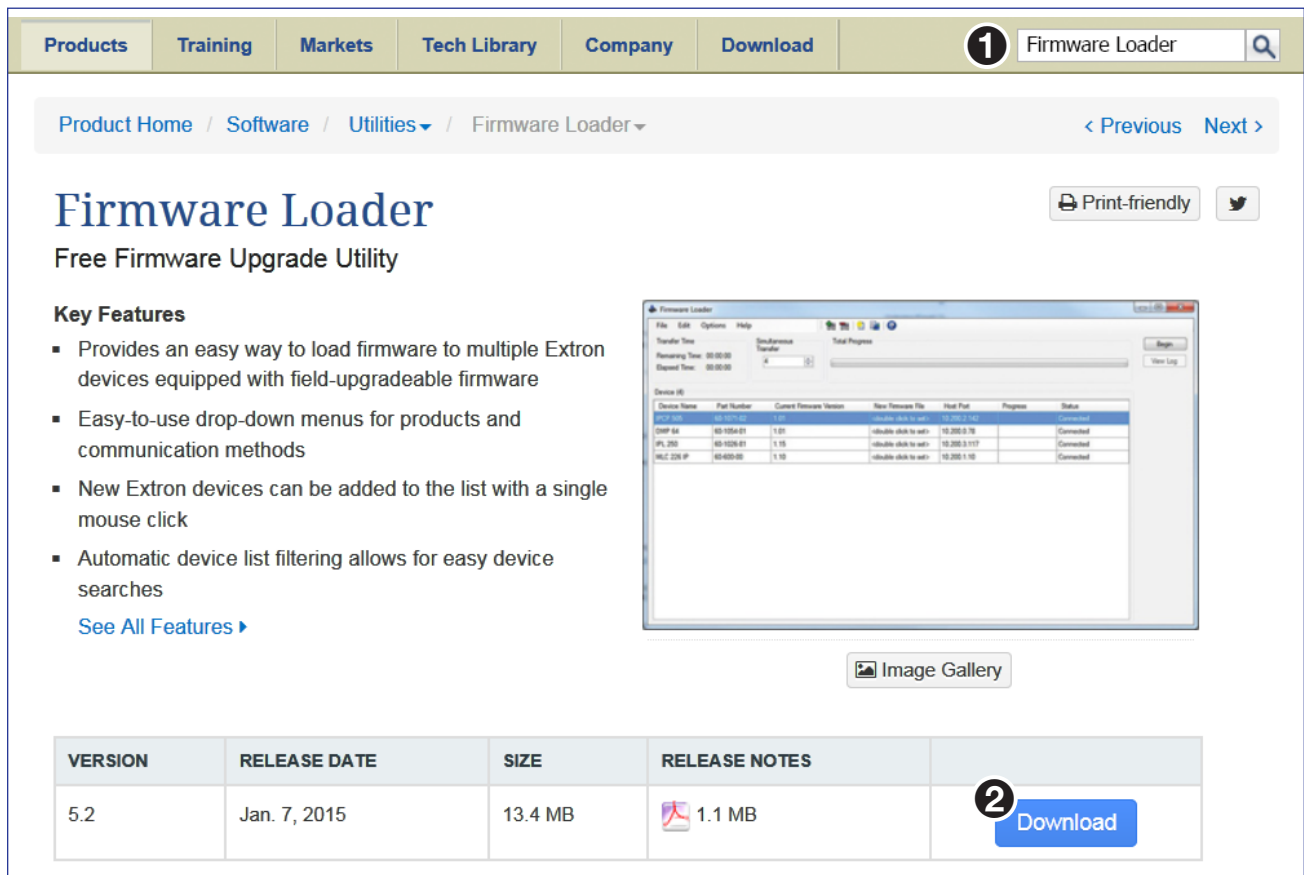

The screenshot shows the Extron website's Firmware Loader page. At the top, there is a navigation bar with links for Products, Training, Markets, Tech Library, Company, and Download. A search bar on the right contains the text "Firmware Loader" and is marked with a circled "1". Below the navigation bar, the breadcrumb trail reads "Product Home / Software / Utilities / Firmware Loader". The main heading is "Firmware Loader" with the subtitle "Free Firmware Upgrade Utility". To the right of the heading are "Print-friendly" and "Twitter" icons. A "Key Features" section lists several bullet points: providing an easy way to load firmware to multiple devices, easy-to-use drop-down menus, adding new devices with a single click, and automatic device list filtering. Below this is a "See All Features" link. To the right of the text is a screenshot of the Firmware Loader application window, which shows a table of devices with columns for Device Name, Part Number, Current Firmware Version, New Firmware File, Host Port, Progress, and Status. Below the application screenshot is an "Image Gallery" button. At the bottom of the page is a table with columns for Version, Release Date, Size, Release Notes, and a Download button. The Download button is marked with a circled "2".

VERSION	RELEASE DATE	SIZE	RELEASE NOTES	
5.2	Jan. 7, 2015	13.4 MB	 1.1 MB	2 Download

Figure 21. Firmware Loader Download Link

3. Click **Download** (②).

4. Follow the instructions on the remainder of the download screens to save the executable **Firmware Loader installer** file to your computer. Note the folder to which the file was saved.
5. In your file browser, locate the downloaded executable installer file and double-click it to launch the installer.
6. Follow the instructions on the **Installation Wizard** dialog boxes to install Firmware Loader on your computer. Unless you specify otherwise, the installer program places the Firmware Loader file, **FWLoader.exe**, at **c:\Program Files\Extron\FWLoader**.

Downloading EDID 101H 4K Firmware

To obtain the latest version of firmware for your device:

1. Go to the Extron website at www.extron.com.
2. Click the **Download** tab.
3. On the **Download Center** page, click the **Firmware** link from the list on the left sidebar menu.
4. The firmware files are arranged in alphabetical order. In the alphabetical list, click “**E**”.
5. Locate the EDID 101H 4K firmware file row and click **Download**.

NOTE: Click **Release Notes**. These notes show the issues addressed by the latest update. If these issues do not affect you, you may decide not to upgrade the firmware.

The **Download Center** page opens.

6. Enter the requested user information, then click **Download**.
7. Follow the instructions on the remainder of the download screens to save the executable firmware file to your computer. Note the folder to which the file was saved.
8. In your file browser, locate the downloaded executable file, and double-click it.
9. Follow the instructions on the **Installation Wizard** dialogs to install the new firmware on your computer. A Release Notes file and a set of instructions for updating the firmware are also loaded.

Loading EDID 101H 4K Firmware

To load a new version of firmware to the device using Firmware Loader, connect your computer to the front panel USB Configuration port (see [Connecting to the USB Port](#) on page 22).

To access the firmware loader:

1. From the Windows start menu, select **All Programs > Extron > Firmware Loader > Firmware Loader**.

The **Add Device** dialog box opens (see figure 22).

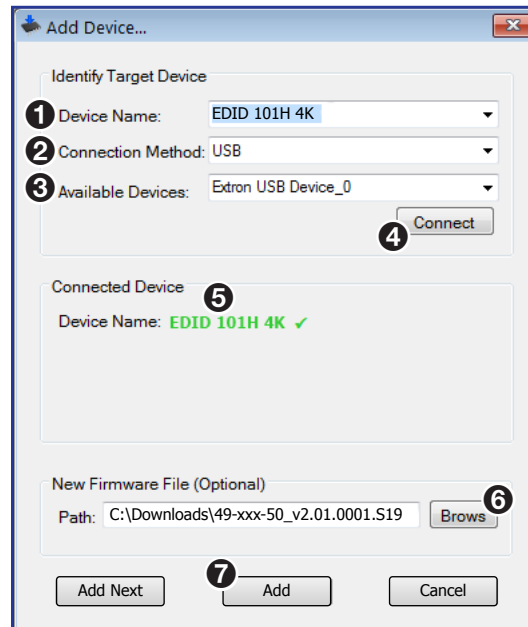

Figure 22. Add Device Dialog

2. From the **Device Name:** drop-down list, select the **EDID 101H 4K** (see 1).
3. From the **Connection Method:** drop-down list, select **USB** (see 2).
4. From the **Available Devices:** drop-down list, select **Extron USB Device** (see 3).
5. Click **Connect** (see 4).

The **Connected Device** panel (5) now displays the device name.

6. Click **Browse** (6), then locate and open the previously downloaded firmware update file.
7. Click **Add** (7).

The main screen opens with the EDID 101H 4K high-lighted (see figure 23).

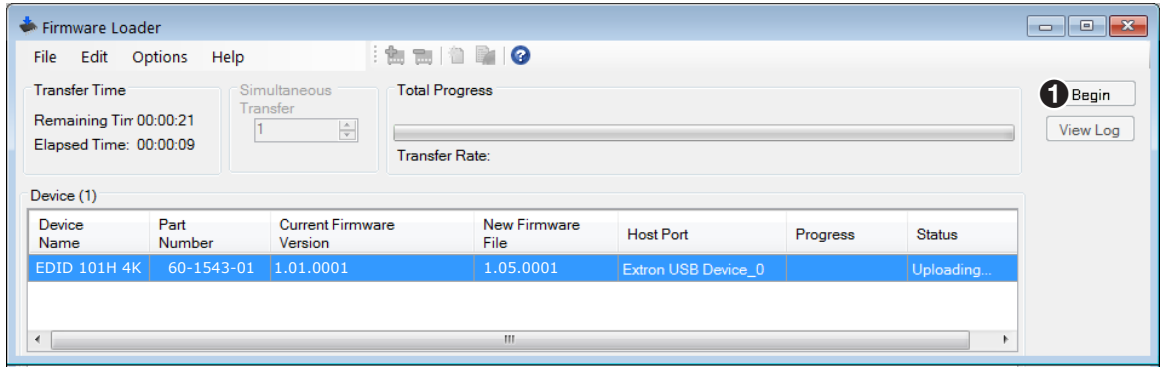

Figure 23. Firmware Loader Main Screen

8. Click **Begin** to start the upgrade (see figure 23, 1).
The **Total Progress** bar visually tracks the uploading progress (see figure 24, 1) and the **Progress** column (2) displays the percentage of completion.

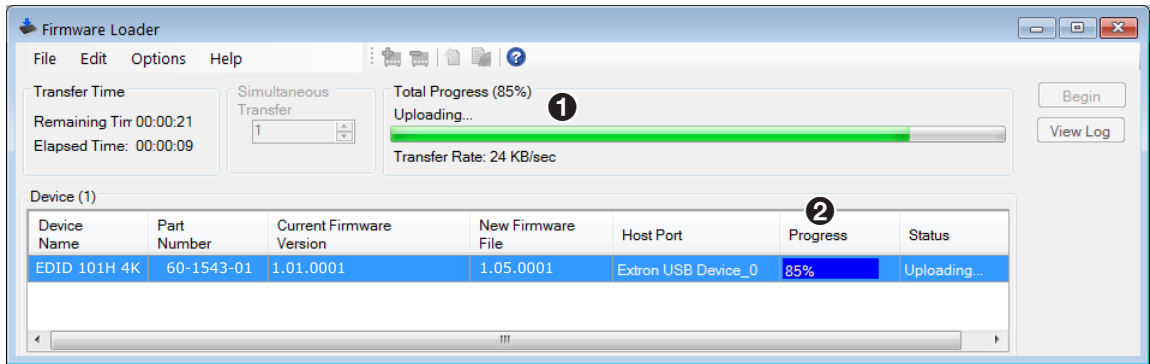

Figure 24. Firmware Loader Progress Bar

9. After uploading the firmware file, the program verifies the file successfully uploaded.
When the verification is finished, the update is completed (see figure 25, 1 and 2).

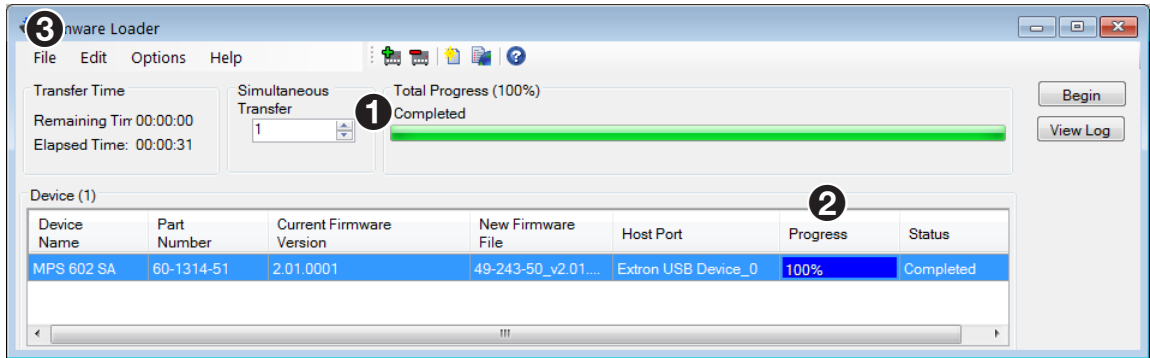

Figure 25. Firmware Loader Completed Firmware Update

10. Select **File > Exit** to exit the program (see figure 25, 3).

Extron Warranty

Extron Electronics warrants this product against defects in materials and workmanship for a period of three years from the date of purchase. In the event of malfunction during the warranty period attributable directly to faulty workmanship and/or materials, Extron Electronics will, at its option, repair or replace said products or components, to whatever extent it shall deem necessary to restore said product to proper operating condition, provided that it is returned within the warranty period, with proof of purchase and description of malfunction to:

USA, Canada, South America, and Central America:

Extron Electronics
1230 South Lewis Street
Anaheim, CA 92805
U.S.A.

Japan:

Extron Electronics, Japan
Kyodo Building, 16 Ichibancho
Chiyoda-ku, Tokyo 102-0082
Japan

Europe and Africa:

Extron Europe
Hanzeboulevard 10
3825 PH Amersfoort
The Netherlands

China:

Extron China
686 Ronghua Road
Songjiang District
Shanghai 201611
China

Asia:

Extron Asia Pte Ltd
135 Joo Seng Road, #04-01
PM Industrial Bldg.
Singapore 368363
Singapore

Middle East:

Extron Middle East
Dubai Airport Free Zone
F13, PO Box 293666
United Arab Emirates, Dubai

This Limited Warranty does not apply if the fault has been caused by misuse, improper handling care, electrical or mechanical abuse, abnormal operating conditions, or if modifications were made to the product that were not authorized by Extron.

NOTE: If a product is defective, please call Extron and ask for an Application Engineer to receive an RA (Return Authorization) number. This will begin the repair process.

USA: 714.491.1500 or 800.633.9876
Asia: 65.6383.4400

Europe: 31.33.453.4040
Japan: 81.3.3511.7655

Units must be returned insured, with shipping charges prepaid. If not insured, you assume the risk of loss or damage during shipment. Returned units must include the serial number and a description of the problem, as well as the name of the person to contact in case there are any questions.

Extron Electronics makes no further warranties either expressed or implied with respect to the product and its quality, performance, merchantability, or fitness for any particular use. In no event will Extron Electronics be liable for direct, indirect, or consequential damages resulting from any defect in this product even if Extron Electronics has been advised of such damage.

Please note that laws vary from state to state and country to country, and that some provisions of this warranty may not apply to you.

Extron Headquarters +1.800.633.9876 (Inside USA/Canada Only) Extron USA - West +1.714.491.1500 +1.714.491.1517 FAX	Extron Europe +800.3987.6673 (Inside Europe Only) Extron USA - East +1.919.850.1000 +1.919.850.1001 FAX	Extron Asia +65.6383.4400 +65.6383.4664 FAX	Extron Japan +81.3.3511.7655 +81.3.3511.7656 FAX	Extron China +86.21.3760.1568 +86.21.3760.1566 FAX	Extron Middle East +971.4.299.1800 +971.4.299.1880 FAX	Extron Australia +61.8.8351.2188 +61.8.8351.2511 FAX	Extron India 1800.3070.3777 (Inside India Only) +91.80.3055.3777 +91.80.3055.3737 FAX
---	---	--	---	---	---	---	--