

HAI 100 4K

HDMI Audio Embedder



Safety Instructions

Safety Instructions • English

WARNING: This symbol, , when used on the product, is intended to alert the user of the presence of uninsulated dangerous voltage within the product's enclosure that may present a risk of electric shock.

ATTENTION: This symbol, , when used on the product, is intended to alert the user of important operating and maintenance (servicing) instructions in the literature provided with the equipment.

For information on safety guidelines, regulatory compliances, EMI/EMF compatibility, accessibility, and related topics, see the Extron Safety and Regulatory Compliance Guide, part number 68-290-01, on the Extron website, www.extron.com.

Sicherheitsanweisungen • Deutsch

WARNUNG: Dieses Symbol , auf dem Produkt soll den Benutzer darauf aufmerksam machen, dass im Inneren des Gehäuses dieses Produktes gefährliche Spannungen herrschen, die nicht isoliert sind und die einen elektrischen Schlag verursachen können.

VORSICHT: Dieses Symbol , auf dem Produkt soll dem Benutzer in der im Lieferumfang enthaltenen Dokumentation besonders wichtige Hinweise zur Bedienung und Wartung (Instandhaltung) geben.

Weitere Informationen über die Sicherheitsrichtlinien, Produkthandhabung, EMI/EMF-Kompatibilität, Zugänglichkeit und verwandte Themen finden Sie in den Extron-Richtlinien für Sicherheit und Handhabung (Artikelnummer 68-290-01) auf der Extron-Website, www.extron.com.

Instrucciones de seguridad • Español

ADVERTENCIA: Este símbolo, , cuando se utiliza en el producto, avisa al usuario de la presencia de voltaje peligroso sin aislar dentro del producto, lo que puede representar un riesgo de descarga eléctrica.

ATENCIÓN: Este símbolo, , cuando se utiliza en el producto, avisa al usuario de la presencia de importantes instrucciones de uso y mantenimiento recogidas en la documentación proporcionada con el equipo.

Para obtener información sobre directrices de seguridad, cumplimiento de normativas, compatibilidad electromagnética, accesibilidad y temas relacionados, consulte la Guía de cumplimiento de normativas y seguridad de Extron, referencia 68-290-01, en el sitio Web de Extron, www.extron.com.

Instructions de sécurité • Français

AVERTISSEMENT : Ce pictogramme, , lorsqu'il est utilisé sur le produit, signale à l'utilisateur la présence à l'intérieur du boîtier du produit d'une tension électrique dangereuse susceptible de provoquer un choc électrique.

ATTENTION : Ce pictogramme, , lorsqu'il est utilisé sur le produit, signale à l'utilisateur des instructions d'utilisation ou de maintenance importantes qui se trouvent dans la documentation fournie avec le matériel.

Pour en savoir plus sur les règles de sécurité, la conformité à la réglementation, la compatibilité EMI/EMF, l'accessibilité, et autres sujets connexes, lisez les informations de sécurité et de conformité Extron, réf. 68-290-01, sur le site Extron, www.extron.com.

Istruzioni di sicurezza • Italiano

AVVERTENZA: Il simbolo, , se usato sul prodotto, serve ad avvertire l'utente della presenza di tensione non isolata pericolosa all'interno del contenitore del prodotto che può costituire un rischio di scosse elettriche.

ATTENZIONE: Il simbolo, , se usato sul prodotto, serve ad avvertire l'utente della presenza di importanti istruzioni di funzionamento e manutenzione nella documentazione fornita con l'apparecchio.

Per informazioni su parametri di sicurezza, conformità alle normative, compatibilità EMI/EMF, accessibilità e argomenti simili, fare riferimento alla Guida alla conformità normativa e di sicurezza di Extron, cod. articolo 68-290-01, sul sito web di Extron, www.extron.com.

Instrukcje bezpieczeństwa • Polska

OSTRZEŻENIE: Ten symbol, , gdy używany na produkt, ma na celu poinformować użytkownika o obecności izolowanego i niebezpiecznego napięcia wewnątrz obudowy produktu, który może stanowić zagrożenie porażenia prądem elektrycznym.

UWAGI: Ten symbol, , gdy używany na produkt, jest przeznaczony do ostrzegania użytkownika ważne operacyjne oraz instrukcje konserwacji (obsługi) w literaturze, wyposażone w sprzęt.

Informacji na temat wytycznych w sprawie bezpieczeństwa, regulacji wzajemnej zgodności, zgodność EMI/EMF, dostępności i Tematy pokrewne, zobacz Extron bezpieczeństwa i regulacyjnego zgodności przewodnik, część numer 68-290-01, na stronie internetowej Extron, www.extron.com.

Инструкция по технике безопасности • Русский

ПРЕДУПРЕЖДЕНИЕ: Данный символ, , если указан на продукте, предупреждает пользователя о наличии неизолированного опасного напряжения внутри корпуса продукта, которое может привести к поражению электрическим током.

ВНИМАНИЕ: Данный символ, , если указан на продукте, предупреждает пользователя о наличии важных инструкций по эксплуатации и обслуживанию в руководстве, прилагаемом к данному оборудованию.

Для получения информации о правилах техники безопасности, соблюдении нормативных требований, электромагнитной совместимости (ЭМП/ЭДС), возможности доступа и других вопросах см. руководство по безопасности и соблюдению нормативных требований Extron на сайте Extron: www.extron.com, номер по каталогу - 68-290-01.

安全说明 • 简体中文

警告:  产品上的这个标志意在警告用户该产品机壳内有暴露的危险电压, 有触电危险。

注意:  产品上的这个标志意在提示用户设备随附的用户手册中有重要的操作和维护(维修)说明。

关于我们产品的安全指南、遵循的规范、EMI/EMF的兼容性、无障碍使用的特性等相关内容, 敬请访问 Extron 网站, www.extron.com, 参见 Extron 安全规范指南, 产品编号 68-290-01。

安全記事・繁體中文

警告: ⚠ 若產品上使用此符號, 是為了提醒使用者, 產品機殼內存在者可能會導致觸電之風險的未絕緣危險電壓。

注意 ⚠ 若產品上使用此符號, 是為了提醒使用者, 設備隨附的用戶手冊中有重要的操作和維護(維修)說明。

有關安全性指導方針、法規遵守、EMI/EMF 相容性、存取範圍和相關主題的詳細資訊, 請瀏覽 Extron 網站: www.extron.com, 然後參閱《Extron 安全性與法規遵守手冊》, 準則編號 68-290-01。

安全上のご注意・日本語

警告: この記号 ⚠ が製品上に表示されている場合は、筐体内に絶縁されていない高電圧が流れ、感電の危険があることを示しています。

注意: この記号 ⚠ が製品上に表示されている場合は、本機の取扱説明書に記載されている重要な操作と保守(整備)の指示についてユーザーの注意を喚起するものです。

安全上のご注意、法規遵守、EMI/EMF適合性、その他の関連項目については、エクストロンのウェブサイト www.extron.com より『Extron Safety and Regulatory Compliance Guide』(P/N 68-290-01) をご覧ください。

안전 지침 · 한국어

경고: 이 기호 ⚠ 가 제품에 사용될 경우, 제품의 인클로저 내에 있는 접지되지 않은 위험한 전류로 인해 사용자가 감전될 위험이 있음을 경고합니다.

주의: 이 기호 ⚠ 가 제품에 사용될 경우, 장비와 함께 제공된 책자에 나와 있는 주요 운영 및 유지보수(정비) 지침을 경고합니다.

안전 가이드라인, 규제 준수, EMI/EMF 호환성, 접근성, 그리고 관련 항목에 대한 자세한 내용은 Extron 웹 사이트(www.extron.com)의 Extron 안전 및 규제 준수 안내서, 68-290-01 조항을 참조하십시오.

Copyright

© 2016-2019 Extron Electronics. All rights reserved.

Trademarks

All trademarks mentioned in this guide are the properties of their respective owners.

The following registered trademarks(®), registered service marks(™), and trademarks(™) are the property of RGB Systems, Inc. or Extron Electronics (see the current list of trademarks on the [Terms of Use](#) page at www.extron.com):

Registered Trademarks (®)

Extron, AVTrac, Cable Cubby, ControlScript, CrossPoint, DTP, eBUS, EDID Manager, EDID Minder, Flat Field, FlexOS, Global Configurator, Global Scriptor, GlobalViewer, Hideaway, Inline, IP Intercom, IP Link, Key Minder, LinkLicense, LockIt, MediaLink, MediaPort, NetPA, PlenumVault, PoleVault, PowerCage, PURE3, Quantum, SoundField, SpeedMount, SpeedSwitch, System *INTEGRATOR*, TeamWork, TouchLink, V-Lock, VersaTools, VN-Matrix, VoiceLift, WallVault, WindoWall, XTP, and XTP Systems

Registered Service Mark (SM): S3 Service Support Solutions

Trademarks (™)

AAP, AFL (Accu-Rate Frame Lock), ADSP (Advanced Digital Sync Processing), Auto-Image, CableCover, CDRS (Class D Ripple Suppression), DDSP (Digital Display Sync Processing), DMI (Dynamic Motion Interpolation), Driver Configurator, DSP Configurator, DSVP (Digital Sync Validation Processing), eLink, EQIP, FastBite, FOX, FOXBOX, IP Intercom HelpDesk, MAAP, MicroDigital, Opti-Torque, ProDSP, QS-FPC (QuickSwitch Front Panel Controller), Room Agent, Scope-Trigger, ShareLink, SIS, Simple Instruction Set, Skew-Free, SpeedNav, Triple-Action Switching, True4K, Vector™ 4K, WebShare, XTRA, ZipCaddy, and ZipClip

FCC Class A Notice

This equipment has been tested and found to comply with the limits for a Class A digital device, pursuant to part 15 of the FCC rules. The Class A limits provide reasonable protection against harmful interference when the equipment is operated in a commercial environment. This equipment generates, uses, and can radiate radio frequency energy and, if not installed and used in accordance with the instruction manual, may cause harmful interference to radio communications. Operation of this equipment in a residential area is likely to cause interference. This interference must be corrected at the expense of the user.

Conventions Used in this Guide

Notifications

The following notifications are used in this guide:

ATTENTION:

- Risk of property damage.
- Risque de dommages matériels.

NOTE: A note draws attention to important information.

Software Commands

Commands are written in the fonts shown here:

```
^ARMerge Scene , ,Op1 scene 1,1 ^B51 ^W^C  
[Ø1] RØØØ4 ØØ3ØØ ØØ4ØØ ØØ8ØØ ØØ6ØØ [Ø2] 35 [17] [Ø3]
```

```
Esc [X1] * [X17] * [X20] * [X23] * [X21] CE ←
```

NOTE: For commands and examples of computer or device responses mentioned in this guide, the character “Ø” is used for the number zero and “O” is the capital letter “o.”

Computer responses and directory paths that do not have variables are written in the font shown here:

```
Reply from 2Ø8.132.18Ø.48: bytes=32 times=2ms TTL=32
```

```
C:\Program Files\Extron
```

Variables are written in slanted form as shown here:

```
ping xxx.xxx.xxx.xxx -t  
SOH R Data STX Command ETB ETX
```

Selectable items, such as menu names, menu options, buttons, tabs, and field names are written in the font shown here:

From the **File** menu, select **New**.

Click the **OK** button.

Specifications Availability

Product specifications are available on the Extron website, www.extron.com.

Contents

Introduction.....	1
About the HAI 100 4K HDMI Audio Embedder ...	1
Features	2
Panels and Cabling	3
Front Panel Features.....	3
Rear Panel Features and Cabling.....	3
Configuration.....	6
Audio Insertion	6
EDID Minder	6
Available EDID	6
Setting EDID with PCS Software.....	7
TMDS Output Format	7
Color bit depth support.....	8
Hot Plug Detect (HPD)	8
Input.....	8
Output.....	8
SIS Commands	9
Connecting a Control Computer	9
Simple Instruction Set (SIS) Control	9
Host-to-Device Communications	9
Error Responses.....	9
Timeout	9
Using the Command and Response Table	9
Command and Response Table for SIS Commands	12

Reference Information	14
Mounting	14
Tabletop Placement	14
Rack Mounting	14
Under-desk and Furniture Mounting.....	15
PCS Software.....	15
Downloading PCS	15
Using PCS.....	16
Updating Firmware with Firmware Loader	16
Downloading Extron Firmware Loader	16
Installing Firmware Loader	16
Downloading Firmware	17
Installing Firmware with Firmware Loader.....	18
Extron Warranty	19

Introduction

This section covers the following topics:

- [About the HAI 100 4K HDMI Audio Embedder](#)
- [Features](#)

About the HAI 100 4K HDMI Audio Embedder

The Extron HAI 100 4K is an audio embedder that embeds two-channel analog audio, or two-channel or multi-channel S/PDIF digital audio onto the HDMI output signal. The HAI 100 4K includes an HDMI input, analog stereo audio and S/PDIF audio inputs, as well as an HDMI output. It is HDCP compliant and supports data rates up to 10.2 Gbps. The HAI 100 4K is compatible with video resolutions up to 4K.

It includes several integrator-friendly features such as adjustable gain control for the analog audio input, EDID Minder® for simplified EDID management between the input source and the display, plus HDMI input cable equalization and comprehensive LED status display. The compact enclosure size simplifies installation in a variety of applications.

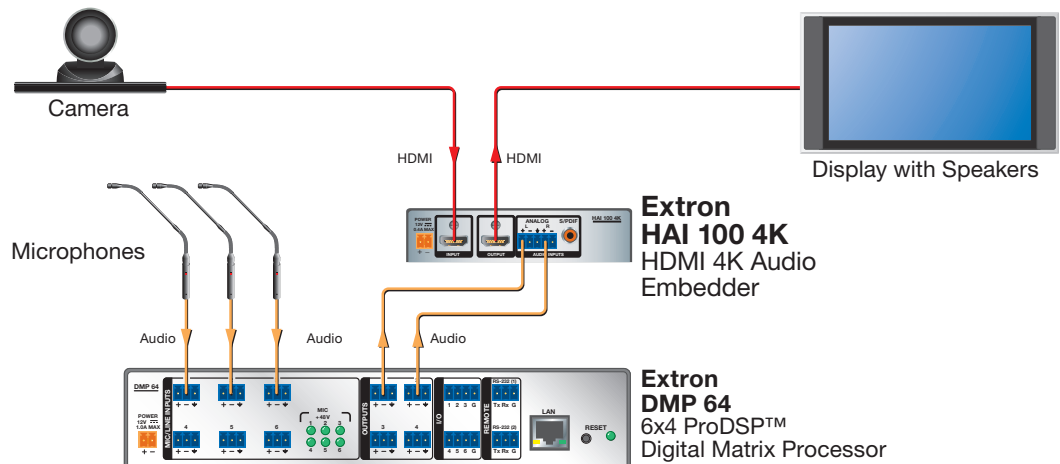

Figure 1. HAI 100 4K Application Diagram

Features

- **Embeds two-channel analog or S/DPDIF digital audio onto an HDMI signal** — The HAI 100 4K offers the flexibility to embed separate analog or digital audio signals onto an HDMI signal.
- **Supports two-channel stereo analog audio, or two-channel or multi-channel S/DPDIF digital audio** — The HAI 100 4K supports incoming analog stereo audio, two-channel LPCM, or Dolby® or DTS® multi-channel audio.
- **Input:** HDMI connector, balanced/unbalanced analog audio on 5-pole captive screw connector, S/DPDIF digital audio on coaxial RCA connector
- **Output:** HDMI connector
- **Supports computer and video resolutions up to 4K**
- **Supported HDMI specification features include data rates up to 10.2 Gbps, Deep Color up to 12-bit, 3D, and CEC pass-through**
- **HDCP compliant**
- **User-selectable HDCP authorization** — Allows the HAI 100 4K to appear HDCP compliant or non-HDCP compliant to the connected source, which is beneficial if the source automatically encrypts all content when connected to an HDCP-compliant device. Protected material is not passed in non-HDCP mode.
- **Selectable output format** — Allows the output video format and color space to be manually configured.
- **HDMI audio pass-through** — The HAI 100 4K provides audio signal pass-through for all embedded audio formats on the HDMI output. The embedded audio output can also be muted.
- **EDID Minder automatically manages EDID communication between connected devices** — EDID Minder ensures that the source powers up properly and reliably outputs content for display.
- **Automatic HDMI input cable equalization to 50 feet (15 meters) at 4K, or 100 feet (30 meters) at 1080p/60 when used with Extron HDMI Pro cables** — Actively conditions incoming HDMI signals to compensate for signal loss when using long cables, low quality cables, or source devices with poor HDMI signal output.
- **Comprehensive, real-time status LED indicators for troubleshooting and monitoring** — Front panel LEDs verify the presence of HDMI input and output signals, and HDCP authentication.
- **Front panel USB configuration port**
- **Easy setup and commissioning with Extron's PCS - Product Configuration Software** — Conveniently configure multiple products using a single software application.
- **Rack-mountable 1" (2.5 cm) high, quarter rack width metal enclosure**
- **Includes LockIt® HDMI cable lacing brackets**
- **Highly reliable, energy-efficient external universal power supply included, replacement part #70-775-01** — Provides worldwide power compatibility, with high demonstrated reliability and low power consumption for reduced operating costs.

Panels and Cabling

This section covers the following:

- [Front Panel Features](#)
- [Rear Panel Features and Cabling](#)

Front Panel Features

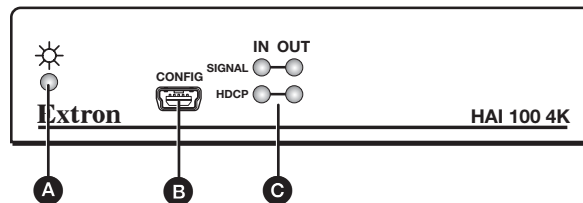

Figure 2. HAI 100 4K Front Panel

- A Power LED** — The LED indicator lights when the unit is receiving power.
- B Config port** — Connect a control PC to this female type B mini USB Config port to update the firmware, configure various functions of the unit, and view the current status of the unit.
- C Input and Output LEDs** — These four LEDs provide the status of the HDMI input and output:
 - **Signal** — Input LED lights when the unit is receiving a signal on the HDMI input. Output LED lights when a sink device is connected to the HDMI output.
 - **HDCP** — Input LED lights when the input signal is HDCP encrypted. Output LED lights when an HDCP compliant sink device is detected and the output is encrypted.

Rear Panel Features and Cabling

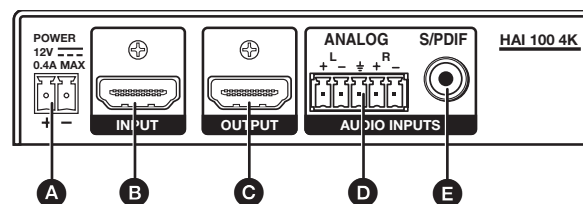

Figure 3. HAI 100 4K Rear Panel

- A Power input** (see the next page)
- B HDMI input** (see page 5)
- C HDMI output** (see page 5)
- D Analog audio input** (see page 5)
- E S/PDIF audio input** (see page 5)

- A Power input** — Connect the provided power supply to the 3.5 mm, 2-pole captive screw power receptacle (see figure 4).

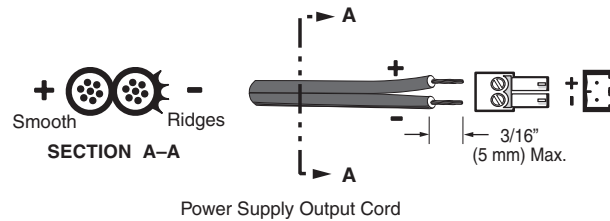

Figure 4. Power Connection

ATTENTION:

- The length of the exposed wires in the stripping process is critical. The ideal length is 3/16 inches (5 mm). Any longer and the exposed wires may touch, causing a short circuit between them. Any shorter and the wires can be easily pulled out even if tightly fastened by the captive screws.
- La longueur des câbles exposés est primordiale lorsque l'on entreprend de les dénuder. La longueur idéale est de 5 mm (3/16 inches). S'ils sont un peu plus longs, les câbles exposés pourraient se toucher et provoquer un court circuit. S'ils sont un peu plus courts, ils pourraient sortir, même s'ils sont attachés par les vis captives.
- Always use a power supply supplied by or specified by Extron. Use of an unauthorized power supply voids all regulatory compliance certification and may cause damage to the supply and the end product.
- Utilisez toujours une source d'alimentation fournie par Extron. L'utilisation d'une source d'alimentation non autorisée annule toute conformité réglementaire et peut endommager la source d'alimentation ainsi que l'unité.
- If not provided with a power supply, this product is intended to be supplied by a power source marked "Class 2" or "LPS" and rated at 12 VDC and a minimum of 1.0 A.
- Si ce produit ne dispose pas de sa propre source d'alimentation électrique, il doit être alimenté par une source d'alimentation de classe 2 ou LPS et paramétré à 12 V et 1.0 A minimum.
- Unless otherwise stated, the AC/DC adapters are not suitable for use in air handling spaces or in wall cavities. The power supply is to be located within the same vicinity as the Extron AV processing equipment in an ordinary location, Pollution Degree 2, secured to the equipment rack within the dedicated closet, podium, or desk.
- Sauf mention contraire, les adaptateurs AC/DC ne sont pas appropriés pour une utilisation dans les espaces d'aération ou dans les cavités murales. La source d'alimentation doit être située à proximité de l'équipement de traitement audiovisuel dans un endroit ordinaire, avec un degré 2 de pollution, fixé à un équipement de rack à l'intérieur d'un placard, d'une estrade, ou d'un bureau.
- The installation must always be in accordance with the applicable provisions of National Electrical Code ANSI/NFPA 70, article 725 and the Canadian Electrical Code part 1, section 16. The power supply shall not be permanently fixed to building structure or similar structure.
- Cette installation doit toujours être en accord avec les mesures qui s'applique au National Electrical Code ANSI/NFPA 70, article 725, et au Canadian Electrical Code, partie 1, section 16. La source d'alimentation ne devra pas être fixée de façon permanente à une structure de bâtiment ou à une structure similaire.

- B HDMI input** — Connect an HDMI input source into this female HDMI type A connector.

NOTE: By default, the EDID stored at the HDMI input is set to 720p at 60 Hz with 2-channel audio. EDID can be configured using Extron PCS software or SIS commands.

- C HDMI output** — Connect an HDMI output device into this female HDMI type A connector.

NOTES:

- It is not required to connect an HDMI output device to extract audio from the HDMI input device.
- The HDMI output passes all audio formats, regardless of configuration. The embedded audio output can also be muted through SIS command.
- If the HDMI input signal is HDCP encrypted, the HDMI output signal will also be encrypted. If the HDMI input signal is not HDCP encrypted, the output signal will not be encrypted.
- If the HDMI input signal is HDCP encrypted and the HDMI output device is not HDCP compliant, the unit outputs a green screen.

- D Analog audio input** — Connect an analog audio device to this 5-pole 3.5 mm captive screw connector (see figure 5). This connector accepts 2-channel stereo balanced or unbalanced audio.

NOTE: Analog audio is embedded automatically by default, replacing any existing embedded digital audio. The input audio format setting can be configured using PCS or SIS commands.

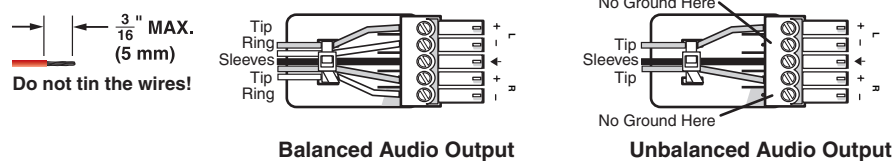

Figure 5. Analog Output Connector Wiring

ATTENTION:

- Connect the sleeve to the ground (Gnd) terminal. Connecting the sleeve to a negative (-) terminal will damage the audio output circuits.
- Connectez le manchon à la terminaison terre (Gnd). Connecter le manchon à une terminaison négative (-) endommagera les circuits de la sortie audio.

- E S/PDIF audio input** — Connect a S/PDIF audio input device into this female RCA connector. This connector accepts digital S/PDIF audio formats (2-channel LPCM, Dolby Digital, or DTS).

NOTES:

- The audio format on this output is determined by the content on the source device.
- By default, the unit is configured to always embed analog audio. Therefore, the S/PDIF input is inactive. The input audio format setting can be configured using PCS or SIS commands.

Configuration

The following HAI 100 4K features can be configured to ensure that the sink devices can handle the signal provided. Use **SIS Commands** (see page 9) to make these configurations. This section provides information on:

- **Audio Insertion**
- **EDID Minder**
- **Output Compatibility Correction**
- **HDCP**

Audio Insertion

The audio insertion setting determines whether audio from the analog audio input or S/PDIF input is inserted, or if the original embedded audio is passed.

The following audio insertion settings can be configured using the **Set Input Audio Format** SIS command on page 12:

- The default setting always embeds analog audio, replacing any existing embedded digital audio.

NOTE: The input analog audio signal gain can also be adjusted through SIS command, from -18 dB to +24 dB in 1dB steps, prior to being embedded. The default is unity gain (0 dB).

- The Auto setting passes embedded audio when detected on the HDMI input and reverts to analog audio when it is not detected.
- The S/PDIF setting inserts audio from the S/PDIF input on the HDMI signal as is.

EDID Minder

EDID Minder allows a source device connected to the HAI 100 4K input to continuously see the EDID of a sink device, even if the sink is not physically connected.

By default, the EDID is set to 720p at 60 Hz with 2-channel audio.

Available EDID

The table on the next page lists all available EDID options, which include:

- **12 Extron factory EDID slots** – Factory EDID is categorized by rate type (IT or CE).
- **1 output slot** that is automatically populated by EDID from the connected sink device. The EDID of the sink device is stored automatically upon hot plug detection (HDP).

NOTE: When the sink is removed or power to the HAI 100 4K is cycled, the EDID is removed from the slot. The EDID is replaced with the default value until a new sink is detected and a new EDID is stored.

- **2 user slots** – These slots contain the default EDID, which can be overwritten by files imported from PCS. The imported files remain in the slots until they are overwritten or the unit is reset.

NOTE: In the table below, **X6** is the SIS symbol representing the EDID file number (1 through 15). To change the EDID, enter the following SIS command (see **SIS Commands** on page 9 for details on entering SIS commands):

Esc A * **X6** EDID ←

(where **X6** = 9 [default EDID] or the desired EDID file number)

X6	Native Resolution	Refresh Rate	Rate Type	Video Format	Audio	Notes
1	1280 x 800	60 Hz	IT	HDMI	2-Ch	
2	1440 x 900	60 Hz	IT	HDMI		
3	1600 x 900	60 Hz	IT	HDMI		
4	1680 x 1050	60 Hz	IT	HDMI		
5	1920 x 1200	60 Hz	IT	HDMI		
6	2560 x 1440	60 Hz	IT	HDMI		
7	2560 x 1600	60 Hz	IT	HDMI		
8	720p	50 Hz	CE	HDMI		
9	720p	60 Hz	CE	HDMI		Default EDID
10	1080p	50 Hz	CE	HDMI		
11	1080p	60 Hz	CE	HDMI		
12	4K/UHD	60 Hz	CE	HDMI		
13	Output (Automatic) - Populated by EDID from sink device					Automatically populated with EDID from connected sink devices.
14	User Slot 1 - Populated through PCS					Populated by the user using PCS software (see page 15)
15	User Slot 2 - Populated through PCS					

Setting EDID with PCS Software

EDID settings and other HAI 100 4K features can be configured using PCS software (see **PCS Software** on page 15).

Output Compatibility Correction

EDID Minder manages the EDID stored at the HDMI input and presented to the source device. However, additional functionality may be required to ensure that all output devices remain compatible with the signal from the source.

The HAI 100 4K scans and monitors the EDID of the sink device connected to the HDMI output. It determines the interface (DVI or HDMI) and color depth, and uses that information to adjust the signal so that it is compatible with the output device.

TMDS Output Format

The TMDS output format has three components:

- **Video format** — either DVI or HDMI
- **Color space** — RGB 4:4:4, YUV 4:2:2, or YUV 4:4:4
- **Quantization range** — either full (0-255) or limited (16-235)

To set the TMDS output format, use the SIS commands shown on page 12.

By default, the output format is configured for Auto, which automatically forces RGB 4:4:4 Full. The video format depends on the source signal and the sink capabilities.

NOTE: When the source signal is detected as 4K/UHD @ 60Hz with YUV 4:2:0 (based on AVI infoframe data), it passes unaltered, overriding the TMDS output format setting. If the TMDS output format is changed while the signal is passing, the setting is applied, but with no observable change. The TMDS output format will resume as configured when the source signal changes to a signal other than 4K/UHD @ 60Hz with YUV 4:2:0.

Other TMDS output formats, which can be set using the **TMDS Output Format** SIS command on page 12, include:

- DVI RGB 4:4:4
- HDMI YUV 4:4:4 Limited
- HDMI RGB 4:4:4 Full
- HDMI YUV 4:2:2 Limited
- HDMI RGB 4:4:4 Limited

Color bit depth support

If the incoming signal uses deep color but the sink device does not support it, the color depth is truncated to the next best color depth, as reported in the sink EDID. The options are:

- 12-bit > 10-bit
- 12-bit > 8-bit
- 10-bit > 8-bit

This feature can be set to always force 8-bit, using the **Output Color Bit Depth** SIS command on page 12.

Hot Plug Detect (HPD)

The HAI 100 4K monitors HPD on each HDMI output to determine if a new sink has been connected. If necessary, the signal for that output is modified in response to the EDID of the connected device.

HDCP

Input

The HAI 100 4K input authenticates HDCP with the source device if the source requires HDCP encryption. The authentication process is repeated whenever the stored EDID is changed or updated.

HDCP support can be disabled using the **Input HDCP Authorization** SIS command on page 12.

Output

The output is authenticated and encrypted according to the configured HDCP output mode (see output modes below). If the output requires encryption but the connected sink device cannot be authenticated, the HAI 100 4K outputs a green screen.

HDCP output modes

- **Follow input** — Output is always authenticated but only encrypted when required by input. HDMI authentication is continuous. DVI authentication occurs for a maximum of 10 seconds, then fails. This is the default mode.
- **Always encrypt output** — Output is always authenticated and encrypted. HDMI authentication is continuous. DVI authentication occurs for a maximum of 10 seconds, then fails.
- **Follow Input (with continuous DVI trials)** — Output is always authenticated but only encrypted when required by input. Both HDMI and DVI authentication are continuous.
- **Always encrypt output (with continuous DVI trials)** — Output is always authenticated and encrypted. Both HDMI and DVI authentication are continuous.

SIS Commands

This section provides information on:

- **Connecting a Control Computer**
- **Simple Instruction Set (SIS) Control**
- **Command and Response Table for SIS Commands**

Connecting a Control Computer

Connect a control PC to the front panel config port using a USB cable (see “**Front Panel Features**” on page 3). Use a communication utility, such as Extron DataViewer, to send SIS commands and view the responses.

Simple Instruction Set (SIS) Control

Host-to-Device Communications

SIS commands consist of one or more characters per field. No special characters are required to begin or end a command sequence. When a command is valid, the interface executes the command and sends a response to the host device. All responses from the interface to the host end with a carriage return and a line feed (CR/LF = **↵**), which signals the end of the response character string. A string is one or more characters.

Error Responses

When the interface receives a valid SIS command, it executes the command and sends a response to the host device. If the interface is unable to execute the command because the command is invalid or it contains invalid parameters, it returns an error response to the host.

The error response codes and their descriptions are as follows:

E10 – Invalid command

E13 – Invalid parameter

Timeout

Pauses of 10 seconds or longer between command ASCII characters result in a timeout. The command operation is aborted with no other indication.

Using the Command and Response Table

The “**Command and Response Table for SIS Commands**” is on page 12. Command and response examples are shown throughout the table. Symbols are used throughout the table to represent variables in the command and response fields. Use the ASCII to HEX conversion table on the next page with the command and response table.

ASCII to Hex Conversion Table														Esc	1B	CR	0D	LF	0A	
Space →	20	!	21	"	22	#	23	\$	24	%	25	&	26	'	27					
	(28)	29	*	2A	+	2B	,	2C	-	2D	.	2E	/	2F				
	0	30	1	31	2	32	3	33	4	34	5	35	6	36	7	37				
	8	38	9	39	:	3A	;	3B	<	3C	=	3D	>	3E	?	3F				
	@	40	A	41	B	42	C	43	D	44	E	45	F	46	G	47				
	H	48	I	49	J	4A	K	4B	L	4C	M	4D	N	4E	O	4F				
	P	50	Q	51	R	52	S	53	T	54	U	55	V	56	W	57				
	X	58	Y	59	Z	5A	[5B	\	5C]	5D	^	5E	_	5F				
	`	60	a	61	b	62	c	63	d	64	e	65	f	66	g	67				
	h	68	i	69	j	6A	k	6B	l	6C	m	6D	n	6E	o	6F				
	p	70	q	71	r	72	s	73	t	74	u	75	v	76	w	77				
	x	78	y	79	z	7A	{	7B		7C	}	7D	~	7E	DEL	7F				

Symbol definitions

- = Space
- ↵ = Carriage return with line feed
- ← = Carriage return with no line feed (used interchangeably with the pipe character, |)
- | = Pipe (vertical bar) character (used interchangeably with the carriage return with no line feed character, ←)
- Esc** = Escape key (used interchangeably with the <W> key)
- X1** = Embedded input audio format:
 - 0 = auto
 - 1 = force existing digital/embedded audio
 - 2 = force embedded analog audio (default)
 - 3 = embed S/PDIF input
- X2** = Video mute:
 - 0 = off (default)
 - 1 = video only
 - 2 = video + sync
- X3** =
 - 0 = off, disabled or not detected
 - 1 = on, enabled, or detected
- X4** = Output HDCP mode (default = 0)
 - 0 = Encrypt as required by input.
 - Continuous trials for HDMI sinks
 - Attempt for 10 seconds on DVI sinks and then fail
 - 1 = Always encrypt
 - Continuous trials for HDMI sinks
 - Attempt for 10 seconds on DVI sinks and then fail
 - 2 = Encrypt as required by input. Continuous trials for HDMI and DVI sink
 - 3 = Always encrypt. Continuous trials for HDMI and DVI sinks.
- X5** = TMDS output format:
 - 0 = Auto (default)
 - 1 = DVI RGB 4:4:4 Full
 - 2 = HDMI RGB 4:4:4 Full
 - 3 = HDMI RGB 4:4:4 Limited
 - 4 = HDMI YUV 4:4:4 Limited
 - 5 = HDMI YUV 4:2:2 Limited
- X6** = EDID slot number from lookup table (see table on page 7)
- X7** = EDID data as 128 or 256 bytes of HEX data (text representation)

X8 = Native resolution and refresh rate from currently assigned EDID
For example: 1920x1080 @60 Hz

X9 = Output color bit depth:
0 = Auto, based on sink EDID (default)
1 = force 8-bit/color

X10 = Verbose mode:
0 = Clear or none
1 = verbose mode (default)
2 = tagged responses for queries
3 = verbose mode and tagged responses for queries

X11 = Device name

NOTE: The name is a text string of up to 24 characters drawn from the alphabet (A-Z), digits (0-9), and minus sign/hyphen (-). No blank or space characters are permitted as part of a name. The first character must be a letter, and the last character must not be a minus sign/hyphen. The factory default is "HAI-100-4K".

X12 = Analog audio gain/attenuation: -18 to +24 in 1dB steps (default = 0)

X13 = Analog audio gain: 0 to 24 in 1dB steps

X14 = Analog audio attenuation: 1 to 18 in 1 dB steps

X15 = Input HDCP status:
0 = No active video source detected
1 = Video detected without HDCP (not encrypted)
2 = Video detected with HDCP (encrypted)

X16 = Output HDCP status:
0 = No sink detected
1 = Non-HDCP sink detected (sink is not HDCP compliant)
2 = HDCP sink detected not encrypted
3 = HDCP sink detected and encrypted

X17 = Output 5V mode:
0 = Auto
5 V is enabled when a source with 5 V is present; otherwise, it is off.
1 = 5 V always enabled (default)

Command and Response Table for SIS Commands

Command	ASCII Command (host to unit)	Response (unit to host)	Additional Description
Signal status			
Input/Output Signal Status	Esc ØLS←	X3 • X3 ← Sig X3 • X3 ←	Input*Output Verbose mode 2/3
Input HDCP Status	Esc IHDCP←	X15 ← HdcpI X15 ←	Verbose mode 2/3
Output HDCP Status	Esc OHDCP←	X16 ← HdcpO X16 ←	Verbose mode 2/3
Video			
Video Mute	X2 B	Vmt X2 ←	
Video Mute Status	B	X2 ← Vmt X2 ←	Verbose mode 2/3
Input HDCP Authorization	Esc E X3 HDCP←	HdcpE X3 ←	
HDCP Authorization Status	Esc EHDCP←	X3 ← HdcpE X3 ←	Verbose mode 2/3
Output HDCP Mode	Esc S X4 HDCP←	HdcpS X4 ←	
Output HDCP Mode Status	Esc SHDCP←	X4 ← HdcpS X4 ←	Verbose mode 2/3
TMDS Output Format	Esc X5 VTPO←	Vtpo X5 ←	
TMDS Output Format Status	Esc VTPO←	X5 ← Vtpo X5 ←	Verbose mode 2/3
Output Color Bit Depth	Esc V X9 BITD←	BitdV X9 ←	
Output Color Bit Depth Status	Esc VBITD←	X9 ← BitdV X9 ←	Verbose mode 2/3
Set Output Hot-Plug Mode (5V)	Esc M X17 HPLG←	Hp1gM X17 ←	
Output Hot-Plug Mode (5V) status	Esc MHPLG←	X17 ← Hp1gM X17 ←	Verbose mode 2/3
Audio			
Set Input Audio Format	Esc I X1 AFMT←	AfmtI X1 ←	X1 = 2 is default
View Input Audio Format	Esc IAFMT←	X1 ← AfmtI X1 ←	Verbose mode 2/3
Mute HDMI Audio Output	X3 Z	Amt X3 ←	
HDMI Audio Output Mute Status	Z	X3 ← Amt X3 ←	Verbose mode 2/3
Set Analog Audio Gain	X13 G	Aud X12 ←	
Set Analog Audio Attenuation	X14 g	Aud X12 ←	
Increment Analog Audio Gain	+G	Aud X12 ←	
Decrement Analog Audio Gain	-G	Aud X12 ←	
View Analog Audio Gain	G	X12 ← Aud X12 ←	Verbose mode 2/3

Command	ASCII Command (host to unit)	Response (unit to host)	Additional Description
EDID Minder			
Assign EDID Slot to Input	[Esc]A[X6]EDID ←	EdidA[X6] ←	
View EDID Assignment	[Esc]AEDID ←	[X6] ← EdidA[X6] ←	Verbose mode 2/3
View EDID in HEX format	[Esc]REDID ←	[X7] ←	HEX data from currently assigned EDID
View EDID Native Rate	[Esc]NEDID ←	[X8] ←	
Info/Other			
Information (unsolicited)	I	Sig[X3]•[X3]•HdcpI[X15]•HdcpO[X16] ←	Signal, input HDCP and output HDCP status
Set Verbose Mode	[Esc][X10]CV ←	Vrb[X10] ←	
Verbose Mode Status	[Esc]CV ←	[X10] ← Vrb[X10] ←	Verbose mode 2/3
Set Unit Name	[Esc][X11]CN ←	Ipn•[X11] ←	
Set Unit Name to Default	[Esc]•CN ←	Ipn•HAI - 100 - 4K ←	
View Unit Name	[Esc]CN ←	[X11] ←	
Query Part Number	N	60 - 1364 - 01 ←	
Query Model Name	1I	HAI - 100 - 4K ← Inf01*HAI - 100 - 4K ←	Verbose mode 2/3
Query Model Description	2I	HDMI Audio Embedder ← Inf02*HDMI Audio Embedder ←	Verbose mode 2/3
Query Firmware Version	Q	x.xx ←	
Query Firmware Version with Build	*Q	x.xx.xxxx ←	

Reference Information

This section contains mounting information and updating firmware methods. Topics in this section include:

- **Mounting**
- **PCS Software**
- **Updating Firmware with Firmware Loader**

Mounting

Tabletop Placement

Attach the four provided rubber feet to the bottom of the unit and place it in any convenient location.

Rack Mounting

UL Guidelines for Rack Mounting

The following Underwriters Laboratories (UL) guidelines are relevant to the safe installation of these products in a rack:

- 1. Elevated operating ambient temperature** — If the unit is installed in a closed or multi-unit rack assembly, the operating ambient temperature of the rack environment may be greater than room ambient temperature. Therefore, install the equipment in an environment compatible with the maximum ambient temperature (TMA = +122 °F, +50 °C) specified by Extron.
- 2. Reduced air flow** — Install the equipment in the rack so that safe operation and adequate air flow is provided to the unit.
- 3. Mechanical loading** — Mount the equipment in the rack so that a hazardous condition is not achieved due to uneven mechanical loading.
- 4. Circuit overloading** — Connect the equipment to the supply circuit and consider the effect that circuit overloading might have on overcurrent protection and supply wiring. Consider the equipment nameplate ratings when addressing this concern.
- 5. Reliable earthing (grounding)** — Maintain reliable grounding of rack-mounted equipment. Pay particular attention to supply connections other than direct connections.

Rack Mounting Procedure

These units can be mounted on optional rack systems listed on the website (see www.extron.com). To mount the unit on a rack shelf, follow the instructions provided with the shelf accessories.

Back of the Rack Mounting Procedure

The HAI 100 4K can be mounted to the rear of a rack using an optional back of rack mounting kit (see www.extron.com). The kit allows the product to be vertically mounted to the front or rear rack supports and face either the front or the rear of the rack. To mount the unit, follow the instructions provided with the kit.

Under-desk and Furniture Mounting

Mount the unit under a desk or podium, using the included under-desk mounting kit. Follow the instructions provided with the kit.

PCS Software

The PCS software application can be used to configure EDID on the HAI 100 4K.

Downloading PCS

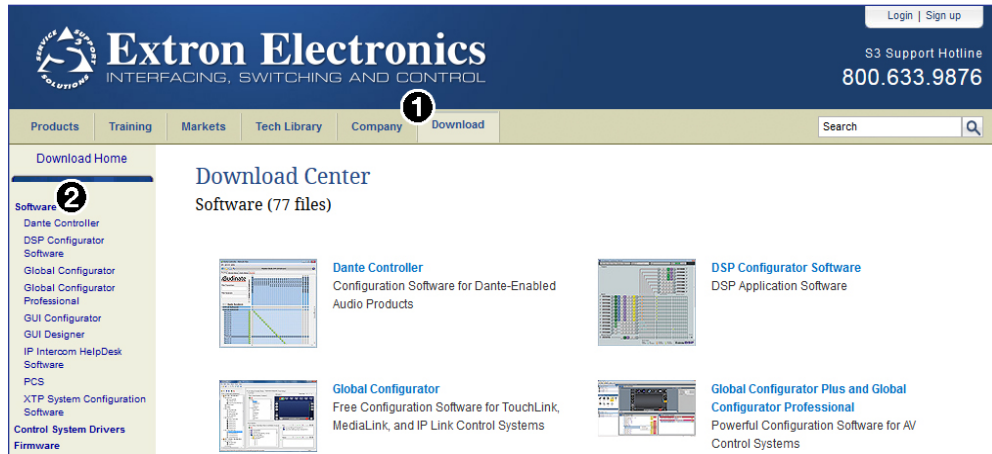

Figure 6. Software on the Extron Website

1. On the Extron [website](http://www.extron.com), click the **Download** tab (see figure 6, 1).
2. From the left sidebar, click the **Software** link (see figure 6, 2). A list of available software opens.

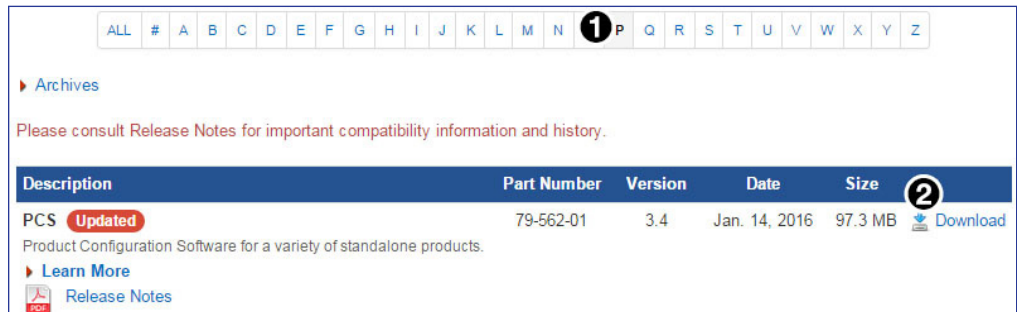

Figure 7. PCS on the Extron Website

3. Navigate to PCS (see figure 7, 1), and click **Download** (see figure 7, 2) on the right.
4. Submit any required information to start the download.

Using PCS

1. Connect a control PC to the HAI 100 4K front panel Config port (see [figure 2](#), **B**, on page 3).
2. Open the PCS software on the control PC.
3. Click **Start > Programs > Extron Electronics > Extron Product Configuration Software > Extron Product Configuration Software**.
4. The PCS Help File contains complete information about using the program to configure the HAI 100 4K.

Updating Firmware with Firmware Loader

To upload and update firmware for the HAI 100 4K, download the new firmware to a connected computer and upload the firmware with the Extron Firmware Loader utility.

Downloading Extron Firmware Loader

1. On the Extron [website](#), click the **Download** tab (see [figure 6](#), **1**, on the previous page).
2. From the left sidebar, click the **Software** link (see [figure 6](#), **2**). A list of available software opens.
3. Navigate to **Firmware Loader** (see [figure 8](#), **1**).

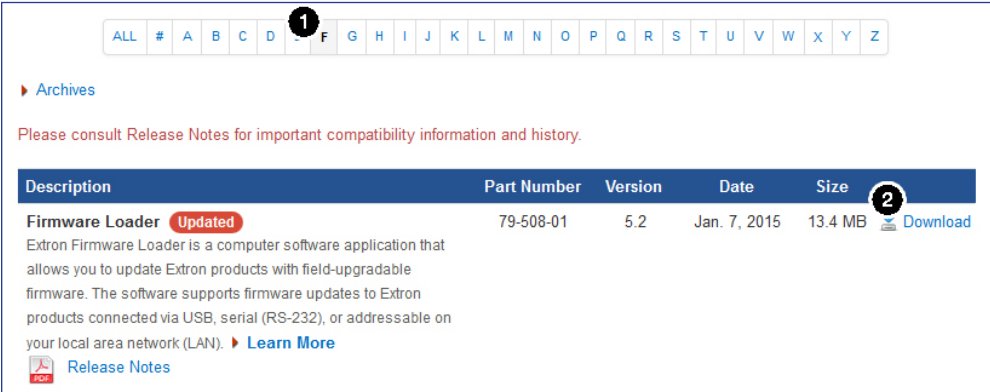

ALL # A B C D **1** F G H I J K L M N O P Q R S T U V W X Y Z

Archives

Please consult [Release Notes](#) for important compatibility information and history.

Description	Part Number	Version	Date	Size	
Firmware Loader Updated Extron Firmware Loader is a computer software application that allows you to update Extron products with field-upgradable firmware. The software supports firmware updates to Extron products connected via USB, serial (RS-232), or addressable on your local area network (LAN). ▶ Learn More	79-508-01	5.2	Jan. 7, 2015	13.4 MB	2 Download

[Release Notes](#)

Figure 8. Firmware Loader on the Extron Website

4. Click the **Download** link (see [figure 8](#), **2**) on the right that corresponds with the program.
5. Submit any required information to start the download.

Installing Firmware Loader

1. Once Firmware Loader has been downloaded, run the .exe file from the location where the file was saved. The installation window opens.
2. Follow the instructions on the installation screens to install Firmware Loader on the computer.

Downloading Firmware

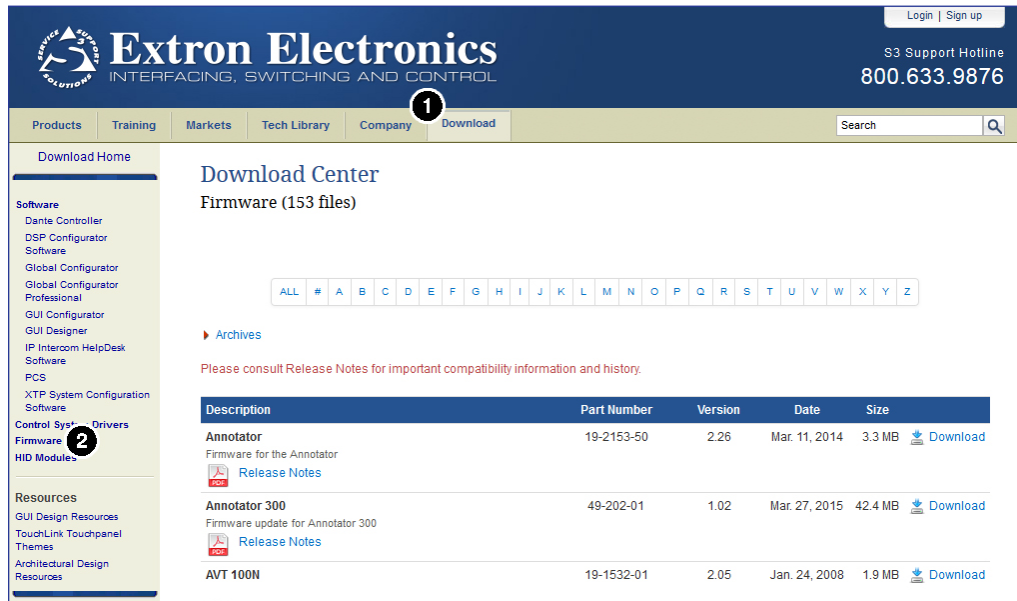

The screenshot shows the Extron Electronics website's Download Center. The page title is "Download Center" and it lists "Firmware (153 files)". A navigation bar at the top includes "Products", "Training", "Markets", "Tech Library", "Company", and "Download" (highlighted with a circled 1). A search bar is on the right. The left sidebar has a "Firmware" link (highlighted with a circled 2) under the "Control Systems - Drivers" category. Below the sidebar is a navigation menu with letters A through Z. The main content area shows a table of firmware files with columns for Description, Part Number, Version, Date, and Size. Each row includes a "Download" link and a "Release Notes" link.

Description	Part Number	Version	Date	Size
Annotator Firmware for the Annotator Release Notes	19-2153-50	2.26	Mar. 11, 2014	3.3 MB Download
Annotator 300 Firmware update for Annotator 300 Release Notes	49-202-01	1.02	Mar. 27, 2015	42.4 MB Download
AVT 100N	19-1532-01	2.05	Jan. 24, 2008	1.9 MB Download

Figure 9. Downloading Firmware from the Extron Website

1. On the Extron [website](#), click the **Download** tab (see figure 9, ①).
2. From the left sidebar, click the **Firmware** link (②).
3. Navigate to HAI 100 4K.
4. Ensure the available firmware version is a later version than the current one on the device.

NOTE: The firmware release notes are a PDF file that provides details about the changes between different firmware versions. The file can be downloaded from the same page as the firmware.

5. Click the **Download** link to the right of the desired device.
6. Submit any required information to start the download. Note where the file is saved.
7. Run the executable file (.exe file extension) and follow the on-screen instructions to place the firmware file and release notes on the PC. Note where the file is saved.

Installing Firmware with Firmware Loader

1. Connect the host device to the front panel USB port.
2. Open Firmware Loader and establish a connection between the computer and the device. The Add Device... dialog box opens.

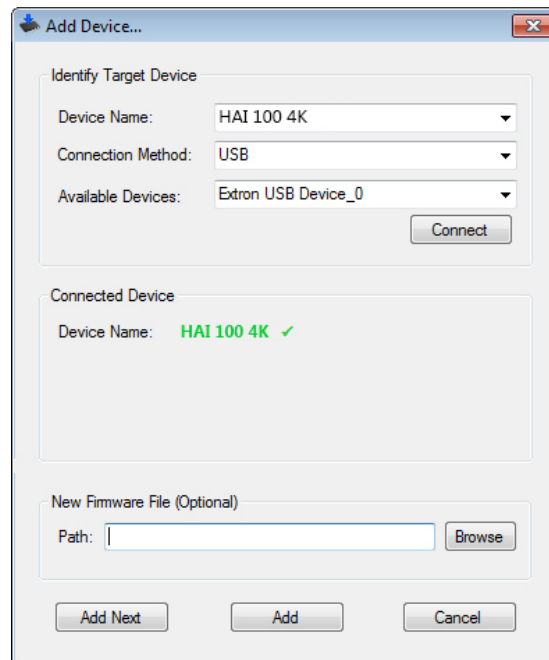

Figure 10. Add Device... Dialog Box

3. From the **Device Name** drop-down list, select **HAI 100 4K**.
4. From the **Connection Method** drop-down list, select the method of connection.
5. Depending on the connection method, additional options appear. Make the appropriate selections for the current connection method.
6. Click the **Connect** button.
7. In the **New File Firmware (Optional)** panel, click **Browse**. The **Open** dialog box opens.
8. In the **Open** dialog box, navigate to the location of the new firmware file, select the desired file.

ATTENTION:

- Valid firmware files must have the file extension **.S19**. A file with any other extension is not a firmware upgrade for this device and could cause the device to stop functioning.
- Les fichiers firmware valides doivent contenir l'extension fichier **S19**. Un fichier avec n'importe quelle autre extension n'est pas une mise à jour de firmware pour cet appareil et l'appareil pourrait arrêter de fonctionner.

9. Click the **Open** button. The **Browse** dialog box closes.
10. Click the **Add** button. The **Add Device...** dialog box closes and the device and firmware are listed in the Firmware Loader main window.
11. Click the **Begin** button to start the upload process.
12. Close Firmware Loader when the **Remaining Time** field shows **00.00.00**, the **Progress** column shows **100%**, and the **Status** field shows **completed**.

Extron Warranty

Extron Electronics warrants this product against defects in materials and workmanship for a period of three years from the date of purchase. In the event of malfunction during the warranty period attributable directly to faulty workmanship and/or materials, Extron Electronics will, at its option, repair or replace said products or components, to whatever extent it shall deem necessary to restore said product to proper operating condition, provided that it is returned within the warranty period, with proof of purchase and description of malfunction to:

USA, Canada, South America,

and Central America:
Extron Electronics
1230 South Lewis Street
Anaheim, CA 92805
U.S.A.

Japan:

Extron Electronics, Japan
Kyodo Building, 16 Ichibancho
Chiyoda-ku, Tokyo 102-0082
Japan

Europe and Africa:

Extron Europe
Hanzeboulevard 10
3825 PH Amersfoort
The Netherlands

China:

Extron China
686 Ronghua Road
Songjiang District
Shanghai 201611
China

Asia:

Extron Asia Pte Ltd
135 Joo Seng Road, #04-01
PM Industrial Bldg.
Singapore 368363
Singapore

Middle East:

Extron Middle East
Dubai Airport Free Zone
F12, PO Box 293666
United Arab Emirates, Dubai

This Limited Warranty does not apply if the fault has been caused by misuse, improper handling care, electrical or mechanical abuse, abnormal operating conditions, or if modifications were made to the product that were not authorized by Extron.

NOTE: If a product is defective, please call Extron and ask for an Application Engineer to receive an RA (Return Authorization) number. This will begin the repair process.

USA: 714.491.1500 or 800.633.9876

Europe: 31.33.453.4040

Asia: 65.6383.4400

Japan: 81.3.3511.7655

Units must be returned insured, with shipping charges prepaid. If not insured, you assume the risk of loss or damage during shipment. Returned units must include the serial number and a description of the problem, as well as the name of the person to contact in case there are any questions.

Extron Electronics makes no further warranties either expressed or implied with respect to the product and its quality, performance, merchantability, or fitness for any particular use. In no event will Extron Electronics be liable for direct, indirect, or consequential damages resulting from any defect in this product even if Extron Electronics has been advised of such damage.

Please note that laws vary from state to state and country to country, and that some provisions of this warranty may not apply to you.

Extron Headquarters +1.800.633.9876 (Inside USA/Canada Only) Extron USA - West +1.714.491.1500 +1.714.491.1517 FAX	Extron USA - East +1.919.850.1000 +1.919.850.1001 FAX	Extron Europe +800.3987.6673 (Inside Europe Only) +31.33.453.4040 +31.33.453.4050 FAX	Extron Asia +65.6383.4400 +65.6383.4664 FAX	Extron Japan +81.3.3511.7655 +81.3.3511.7656 FAX	Extron China +86.21.3760.1568 +86.21.3760.1566 FAX	Extron Middle East +971.4.299.1800 +971.4.299.1880 FAX	Extron Korea +82.2.3444.1571 +82.2.3444.1575 FAX	Extron India 1800.3070.3777 (Inside India Only) +91.80.3055.3777 +91.80.3055.3737 FAX
---	--	---	--	---	---	---	---	---