

User's Manual





SENTOSaxi
LINE QUADRUPLER

LANCIAxi
LINE DOUBLER

Safety Instructions • English

 This symbol is intended to alert the user of important operating and maintenance (servicing) instructions in the literature provided with the equipment.

 This symbol is intended to alert the user of the presence of uninsulated "dangerous voltage" within the product's enclosure that may present a risk of electric shock.

 **CAUTION**
Risk of Electrical Shock. Do Not Open!
Caution: To prevent the risk of shock, do not remove the cover (or open the enclosure). There are no user-serviceable parts inside. Refer servicing to qualified service personnel.

Caution

Read Instructions • Read and understand all safety and operating instructions before using the equipment.

Retain Instructions • The Safety Instructions should be kept for future reference.

Follow Warnings • Follow all warnings and instructions marked on the equipment or in the user information.

Avoid Attachments • Do not use (tools or) attachments that are not recommended by the equipment manufacturer because they may be hazardous.

Warning

Power Sources • This equipment should be operated only from the power source indicated on the product. This equipment is intended to be used with a main power system with a grounded (neutral) conductor. The third (grounding) pin is a safety feature, do not attempt to bypass or disable it.

Power Disconnection • To remove power from the equipment safely, remove all power cords from the rear of the equipment, or the desktop power module (if detachable), or from the power source receptacle (wall plug).

Power Cord Protection • Power cords should be routed so that they are not likely to be stepped on or pinched by items placed upon or against them.

Servicing • Refer all servicing to qualified service personnel. Do not attempt to service this equipment yourself because opening or removing covers may expose you to dangerous voltage or other hazards.

Slots and Openings • If the equipment has slots or holes in the enclosure, these are provided to prevent overheating of sensitive components inside. These openings must never be blocked by other objects.

Lithium Battery • Danger of explosion if battery is incorrectly replaced. Replace only with the same or equivalent type recommended by the manufacturer. Dispose of used batteries according to the manufacturer's instructions.

Sicherheitsanleitungen • Deutsch

 Dieses Symbol soll den Benutzer auf wichtige Anleitungen zur Bedienung und Wartung (Instandhaltung) in der Dokumentation hinweisen, die im Lieferumfang dieses Gerätes enthalten ist.

 Dieses Symbol soll den Benutzer darauf aufmerksam machen, daß im Inneren des Gehäuses dieses Produktes gefährliche Spannungen, die nicht isoliert sind und die einen elektrischen Schock verursachen können, herrschen.

 **CAUTION**
Risk of Electrical Shock. Do Not Open!
Achtung: Zur Vermeidung eines elektrischen Schocks bitte nicht die Abdeckung entfernen (oder das Gehäuse öffnen). Im Inneren des Gerätes sind keine Teile enthalten, die vom Benutzer gewartet werden können. Eine Wartung sollte nur durch einen qualifizierten technischen Service durchgeführt werden.

Achtung

Lesen der Anleitungen • Bevor Sie das Gerät zum ersten Mal verwenden, sollten Sie alle Sicherheits- und Bedienungsanleitungen genau durchlesen und verstehen.

Aufbewahren der Anleitungen • Die Sicherheitsanleitungen sollten aufbewahrt werden, damit Sie später darauf zurückgreifen können.

Befolgen der Warnhinweise • Befolgen Sie alle Warnhinweise und Anleitungen auf dem Gerät oder in der Benutzerdokumentation.

Keine Zusatzgeräte • Verwenden Sie keine (Werkzeuge oder) Zusatzgeräte, die nicht ausdrücklich vom Hersteller empfohlen wurden, da diese eine Gefahrenquelle darstellen können.

Vorsicht

Stromquellen • Dieses Gerät sollte nur über die auf dem Produkt angegebene Stromquelle betrieben werden. Dieses Gerät würde für eine Verwendung mit einer Hauptstromleitung mit einem geerdeten (neutralen) Leiter konzipiert. Der dritte Stift oder Kontakt ist für einen Erdschluß, und stellt eine Sicherheitsfunktion dar und sollte nicht umgangen oder außer Betrieb gesetzt werden.

Stromunterbrechung • Um das Gerät auf sichere Weise vom Netz zu trennen, sollten Sie alle Netzkabeln aus der Rückseite des Gerätes oder aus dem Desktop-Strommodul (falls dies möglich ist) oder aus der Wandsteckdose ziehen.

Schutz des Netzkabels • Netzkabel sollten stets so verlegt werden, daß sie nicht im Weg liegen und niemand darauf treten oder Objekte darauf- oder unmittelbar dagegen gestellt werden können.

Wartung • Alle Wartungsmaßnahmen sollten nur von qualifiziertem Servicepersonal durchgeführt werden. Versuchen Sie in keinem Fall, dieses Gerät selbst zu warten, da beim Öffnen oder Entfernen der Abdeckungen die Gefahr eines elektrischen Schlags oder anderer Gefahren bestehen.

Schlitze und Öffnungen • Wenn das Gerät Schlitze oder Löcher im Gehäuse aufweist, dienen diese zur Vermeidung einer Überhitzung der empfindlichen Teile im Inneren. Diese Öffnungen dürfen niemals von anderen Objekten blockiert werden.

Lithium-Batterie • Explosionsgefahr, falls die Batterie nicht richtig ersetzt wird. Ersetzen Sie nur durch diegleiche oder einen vergleichbaren Batterietyp, der auch vom Hersteller empfohlen wird. Entsorgung der verbrauchten Batterien bitte gemäß den Herstelleranweisungen.

Consignes de Sécurité • FRANÇAIS

 Ce symbole sert à avertir l'utilisateur que la documentation fournie avec le matériel contient des instructions importantes concernant l'exploitation et la maintenance (réparation).

 Ce symbole sert à avertir l'utilisateur de la présence dans le boîtier de l'appareil de « tensions dangereuses » non isolées posant des risques d'électrocution.

 **CAUTION**
Risk of Electrical Shock. Do Not Open!
Attention : Afin d'éviter tout danger d'électrocution, ne pas enlever la couverture (ni ouvrir le boîtier). Aucun des éléments internes ne peut être réparé par l'utilisateur. S'adresser à un technicien de maintenance qualifié.

Attention

Lire les instructions • Prendre connaissance de toutes les consignes de sécurité et d'exploitation avant d'utiliser le matériel.

Conservier les instructions • Ranger les consignes de sécurité afin de pouvoir les consulter à l'avenir.

Respecter les avertissements • Observer tous les avertissements et consignes marqués sur le matériel ou présentés dans la documentation utilisateur.

Éviter les pièces de fixation • Ne pas utiliser de pièces de fixation (ni d'outils) non recommandés par le fabricant du matériel car cela risquerait de poser certains dangers.

Avertissement

Alimentations • Ne faire fonctionner ce matériel qu'avec la source d'alimentation indiquée sur l'appareil. Ce matériel doit être utilisé avec une alimentation principale comportant un fil de terre (neutre). Le troisième contact (de mise à la terre) constitue un dispositif de sécurité : n'essayez pas de le contourner ni de la désactiver.

Déconnexion de l'alimentation • Pour mettre le matériel hors tension sans danger, déconnectez tous les cordons d'alimentation de l'arrière de l'appareil ou du module d'alimentation de bureau (s'il est amovible) ou encore de la prise secteur.

Protection du cordon d'alimentation • Acheminer les cordons d'alimentation de manière à ce que personne ne risque de marcher dessus et à ce qu'ils ne soient pas écrasés ou pinçés par des objets.

Réparation-maintenance • Faire exécuter toutes les interventions de réparation-maintenance par un technicien qualifié. L'utilisateur ne doit pas essayer de procéder lui-même à ces opérations car l'ouverture ou le retrait des couvercles risquent de l'exposer à de hautes tensions et autres dangers.

Fentes et orifices • Si le boîtier de l'appareil comporte des fentes ou des orifices, ceux-ci servent à empêcher les composants internes sensibles de surchauffer. Ces ouvertures ne doivent jamais être bloquées par des objets.

Lithium Batterie • Il a danger d'explosion s'il y a un remplacement incorrect de la batterie. Remplacer uniquement avec une batterie du même type ou d'un type équivalent recommandé par le constructeur. Disposer des batteries usagées conformément aux instructions du fabricant.

Instrucciones de seguridad • Español

 Este símbolo se utiliza para advertir al usuario sobre instrucciones importantes de operación y mantenimiento (o cambio de partes) que se desean destacar en el contenido de la documentación suministrada con los equipos.

 Este símbolo se utiliza para advertir al usuario sobre la presencia de elementos con "voltajes peligrosos" sin protección aislante, que puedan encontrarse dentro de la caja o alojamiento del producto, y que puedan representar riesgo de electrocución.

 **CAUTION**
Risk of Electrical Shock. Do Not Open!
Precaución: Para evitar riesgo de electrocución, no extraer la tapa (ni abrir la caja). En el interior no hay partes a las que el usuario deba acceder. Solicitar el servicio de personal técnico calificado.

Precaución

Leer las instrucciones • leer y analizar todas las instrucciones de operación y seguridad, antes de usar el equipo.

Conservar las instrucciones • conservar las Instrucciones de Seguridad para futura consulta.

Obedecer las advertencias • todas las advertencias e instrucciones marcadas en el equipo o en la documentación del usuario, deben ser obedecidas.

Evitar el uso de accesorios • no usar herramientas o accesorios que no sean específicamente recomendados por el fabricante, ya que podrían implicar riesgos.

Advertencia

Alimentación eléctrica • este equipo debe conectarse únicamente a la fuente/tipo de alimentación eléctrica indicada en el mismo. La alimentación eléctrica de este equipo debe provenir de un sistema de distribución general con conductor neutro a tierra. La tercera pata (puesta a tierra) es una medida de seguridad, no puede ni eliminarse.

Desconexión de alimentación eléctrica • para desconectar con seguridad la acometida de alimentación eléctrica al equipo, desenchufar todos los cables de alimentación en el panel trasero del equipo, o desenchufar el módulo de alimentación (si fuera independiente), o desenchufar el cable del receptáculo de la pared.

Protección de los cables de alimentación • los cables de alimentación eléctrica se deben instalar en lugares donde no sean pisados ni apretados por objetos que se puedan apoyar sobre ellos.

Reparaciones/mantenimiento • solicitar siempre los servicios técnicos de personal calificado. No intentar personalmente la reparación/mantenimiento de este equipo, ya que al abrir o extraer las tapas puede quedar expuesto a voltajes peligrosos u otros riesgos.

Ranuras y aberturas • si el equipo posee ranuras u orificios en su caja/aljofarado, es para evitar el sobrecalentamiento de componentes internos sensibles. Estas aberturas nunca se deben obstruir con otros objetos.

Batería de litio • existe riesgo de explosión si esta batería se coloca en la posición incorrecta. Cambiar esta batería únicamente con el mismo tipo (o su equivalente) recomendado por el fabricante. Desachar las baterías usadas siguiendo las instrucciones del fabricante.

Extron's Warranty

Extron Electronics warrants the product against defects in materials for a period of two years and defect in workmanship for a period of two years from the date of purchase. In the event of malfunction during the warranty period attributable directly to faulty workmanship and/or materials, Extron Electronics will, at its option, repair or replace said products or components, to whatever extent it shall deem necessary to restore said product to proper operating condition, provided that it is returned within the warranty period, with proof of purchase and description of malfunction to:

Extron Electronics
1230 South Lewis Street
Anaheim, CA 92805, U.S.A.

This Limited Warranty does not apply if the fault has been caused by misuse, improper handling care, electrical or mechanical abuse, abnormal operating conditions, or any modification to the product not authorized by Extron Electronics.

Before calling Extron, get the serial number of the unit in question, a description of the problem and the name of the person to contact in case there are any questions. This will speed up the process. With this information in hand, call an Extron Applications Engineer at (714) 491-1500 and ask for a Return Authorization number (RA#).

Returned units must be insured, with shipping charges prepaid. If not insured, you assume the risk of loss or damage during shipment. Extron Electronics make no further warranties either expressed or implied with respect to the product and its quality, performance, merchantability, or fitness for any particular use. In no event will Extron Electronics be liable for direct, indirect, or consequential damages resulting from any defect in this product even if Extron Electronics has been advised of such damage.

Please note that laws vary from state to state, and that some provisions of this warranty may not apply to you.



Extron Electronics
1230 South Lewis Street
Anaheim, CA 92805
(714) 491-1500 FAX (714) 491-1517
U.S.A.

Extron Electronics, Europe
Beeldschermweg 6C
3821 AH Amerfoort
+31-33-453-4040 FAX +31-33-453-4050
The Netherlands

Extron Electronics, Asia
41B Kreta Ayer Road
Singapore 089003
+65-226-0015 FAX +65-226-0019
Singapore

Contents

Introduction to Sentosaxi/LQ & Lanciaxi/LD	Chapter 1
Introduction	1-1
About this Manual	1-1
Features	1-2
Specifications	1-3
Installation and Operation	Chapter 2
Installing the Sentosaxi/Lanciaxi	2-1
Rack Mounting	2-1
Cabling	2-1
Connecting the Input and Output Cables	2-1
Connecting the RS-232 Cable	2-2
Switch Settings	2-3
DIP Switch Module	2-4
Front and Rear Panels	2-5
Front Panel	2-5
Rear Panel	2-6
Operation	2-7
Application Diagrams	2-7
Video Loop Back Application	2-9
RS-232/REMOTE Control	Chapter 3
RS-232 Control	3-1
Host/Sentosaxi/Lanciaxi Communications	3-1
Using the Command/Response Table	3-1
Command/Response Table	3-2
Error Responses	3-3
Sentosaxi/Lanciaxi-Initiated Responses	3-3
Sentosaxi/Lanciaxi Control Software	3-3
Installing the Software	3-3
Using the Software	3-4
Remote Contact Closure Operation	3-5
Other Reference Material	Appendix A
Accessories/Part Numbers	A-1
Safety Instructions	Inside Front Cover
Limited Warranty	Inside Back Cover

*Written and Printed in the USA
Sentosaxi Line Quadrupler
Lanciaxi Line Doubler
User's Manual
68-254-01
Rev. C
89-05*

Legend of Icons

The following icons may be used in this manual:

 — *Important information – for example, an action or a step that must be done before proceeding.*

 — *A Warning – possible damage could occur.*

 — *A Note, a Hint, or a Tip that may be helpful.*

 — *Possible Electrostatic Discharge (ESD) damage could result from touching electronic components.*

 — *Additional information may be referenced in another section, or in another document.*

*Extron's SENTOSA_{xi} & LANCIA_{xi}
User's Manual*



Chapter One

Introduction to Sentosaxi & Lanciaxi

Introduction

Features

Specifications

Introduction

About This Manual

This manual contains operation/configuration information for the Sentosa_{xi} Line Quadrupler (LQ) and Lanci_{xi} Line Doubler (LD).

Sentosaxi LQ and Lanci_{xi} LD Facts and Features

Extron's Sentosa_{xi} LQ and Lanci_{xi} LD are high resolution, digital video devices which convert interlaced video into non-interlaced video. The Sentosa_{xi} LQ and Lanci_{xi} LD convert the two field frame into a single non-interlaced frame consisting of 1,050 lines (LQ) and 525 lines (LD) producing a brighter, higher resolution picture. The additional lines provide more light output and make the overall image brighter.

The Sentosa_{xi} and Lanci_{xi} each have a high quality three-line adaptive comb filter that eliminates most of the chroma noise found in standard composite video signals. In addition, an internal TBC (Time Base Corrector) actually cleans-up low quality video-tape signal noise (common to VHS tape players) for a more stable and sharper image. Motion mode compensation virtually eliminates the "jaggies" commonly found on video line quadruplers and line doublers so that the image is smoother.

The Sentosa_{xi} LQ and Lanci_{xi} LD include an internal two input switcher - one S-Video and one composite video input are front panel selectable, remote selectable as well as auto-switchable. With the use of a high quality quad-standard decoder the Sentosa_{xi} LQ and Lanci_{xi} LD are compatible with all international video formats including NTSC 3.58, NTSC 4.43, PAL and SECAM.

Features

Features unique to the **Sentosaxi LQ** include the following.

- **Line quadrupler** - Quadruples the resolution of standard video from 525 lines at 15 kHz to 1050 non-interlaced lines at 63 kHz for a clearer brighter output.
- **Demo-mode** - Built-in "demo mode" allows a triple-split screen of video, line doubled and line quadrupled video side by side.

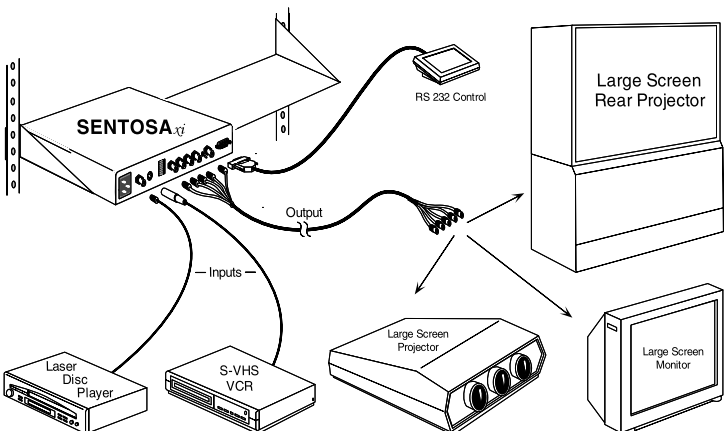

Features unique to the **Lanciaxi LD** include the following.

- **Line doubler** - Doubles the resolution of standard video from 525 interlaced lines at 15 kHz to 525 non-interlaced lines at 31.5 kHz for a clearer, brighter output.
- **Demo-mode** - Built-in “demo mode” allows split screen of video and line doubled video side by side.
- **VGA mode** - Conveniently converts video signals to 480 lines of non-interlaced VGA. This VGA output allows you to plug directly into digital display devices for RGBHV signal transmission.

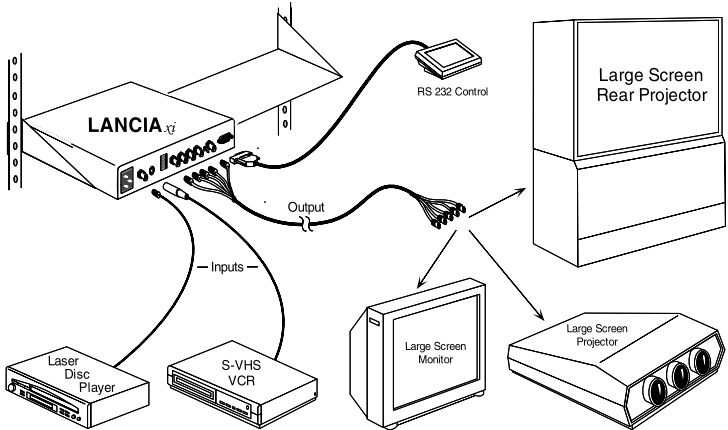

Features of *Sentosaxi* and *Lanciaxi* include the following.

- **Quad-standard decoder** - *Sentosaxi* and *Lanciaxi* are compatible with all international video formats including NTSC 3.58, NTSC 4.43, PAL and SECAM.
- **Motion mode compensation** - With motion mode compensation, the *Sentosaxi* and *Lanciaxi* virtually eliminate the “jaggies” found in line quadrupled or line doubled video.
- **Picture controls** - Picture controls include color, hue (tint), horizontal shift and contrast for each input. The *Sentosaxi* and *Lanciaxi* will save picture controls for each of the two inputs.
- **RS-232 control** - A rear panel RS-232 serial port provides access for a third-party remote control system.
- **Input sync detection** - In auto-switch mode the input with a signal present is automatically selected, perfect for the video loop-back feature of the System 8 and 10 PLUS switchers.
- **Universal compatibility** - Outputs either RGsB, RGBS or RGBHV signals at 31.5 kHz for the *Lanciaxi* and 63 kHz for the *Sentosaxi*.
- **Output sync polarity** - Sync polarity can be adjusted through rear panel DIP switches (positive or negative H&V) to allow for any projector to recognize the *Sentosaxi* or *Lanciaxi* input versus a standard VGA input and save different convergence, brightness and contrast settings.
- **Rack mountable** - The *Sentosaxi* and *Lanciaxi* fit into a 1U high, 1/2 rack width metal enclosure.

Sentosaxi LQ & Lanciaxi LD Specifications

- Inputs**
- Video level .. 0.7 – 1 volt p-p
 - S-Video level (Y/C) .. Y = 0.7 volts p-p
 - .. C = 0.3 volts p-p (burst)
 - Connectors .. Video - female BNC
 - .. S-Video - female 4-pin mini-DIN
 - Impedance .. 75 ohms
- Outputs**
- Video level .. 0.7 volts p-p
 - Sync level .. 4-5 volts p-p (TTL)
 - Sync polarity .. Composite – Negative
 - .. H&V – Positive or Negative
 - .. (DIP switch selectable)
- Sync output frequency .. Lanciaxi
- NTSC 3.58/4.43 .. 31.5 kHz horizontal
 - .. 60 Hz vertical
 - PAL/SECAM .. 31.25 kHz horizontal
 - .. 50 Hz vertical
- NOTE: When Lanciaxi VGA mode is active, vertical frequency is forced to 60 Hz with any video input.
- Sync output frequency .. Sentosaxi
- NTSC 3.58/4.43 .. 63 kHz horizontal
 - .. 60 Hz vertical
 - PAL/SECAM .. 62.5 kHz horizontal
 - .. 50 Hz vertical
- DC offset .. 0.1 volt (max)
 - Connectors .. 5 female BNCs
 - Impedance .. 75 Ohms
- General**
- Remote control .. RS-232 and contact closure
 - Bandwidth .. 50 MHz (-3 dB)
 - MTBF .. 30,000 hours (demonstrated)
 - Storage temp .. -40 C to 70 C (-32 to 158 F)
 - Operating temp .. 0 C to +50 C (-32 to 122 F)
 - Humidity .. 10% to 90% non condensing
 - Vibration .. NSTA 1A in carton
 - Dimensions .. 1.75" H x 8.75" W x 9.5" D
 - .. 4.45 x 22.22 x 24.13 cm
 - Rack mountable .. Yes, 1U shelf (Part # 60-190-01)
 - Weight .. 5.0 lbs
 - .. 2.3 kg
 - Approvals .. UL, CE mark
 - Power supply .. 100-240 VAC, 50/60 Hz
 - .. Internal auto-switchable
 - Warranty .. Two Years, parts & Labor



Chapter Two

Installation and Operation

Rack Mounting

Cabling

Switch Settings

DIP Switch Module

Front and Rear Panels

Operation

Applications

Installing the Sentosaxi/Lanciaxi

If rack mounting is required it should be done before cabling, otherwise, skip to "Cabling" below.

Rack Mounting

The Sentosaxi/Lanciaxi can be rack mounted using one side of an optional 19" 1U Universal Rack Shelf (Extron PN# **60-190-01**). To rack mount the Sentosaxi/Lanciaxi, do the following:

1. If feet were previously installed on the bottom of the case, remove them.
2. Mount the Sentosaxi/Lanciaxi on the rack shelf as shown below using two 4-40 x 1/8 screws in opposite (diagonal) corners to secure the case to the shelf.
3. Upon completion of the rack mounting procedure, go to "Cabling" below.

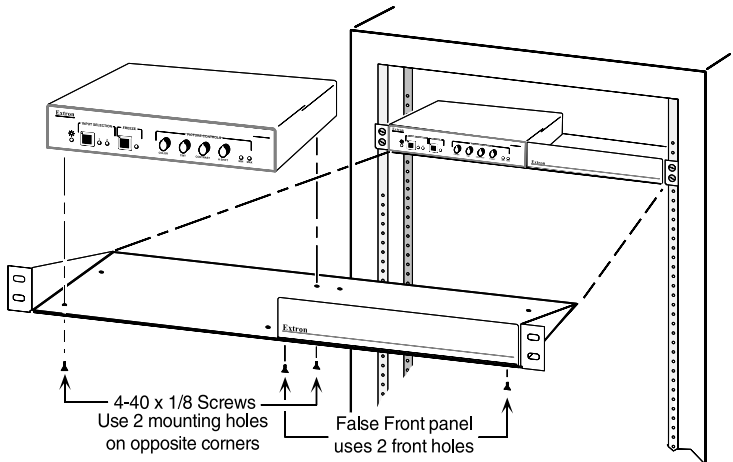

Cabling

The Sentosaxi/Lanciaxi is capable of switching between two inputs, one composite and one S-Video. Therefore, one of each video input type may be connected.

Connecting the Input/Output Cables

1. Connect the input devices to the Sentosaxi/Lanciaxi using the appropriate cables as described below. Use the diagram on the next page as a general guide.
 - A. If the input device to be connected has an S-Video output, an S-Video cable will be used to connect it to the S-Video input connector of the Sentosaxi/Lanciaxi.
 - B. If the input device to be connected has a composite video output, a BNC cable will be used to connect it to the BNC input of the Sentosaxi/Lanciaxi. The composite video output from a VCR or Laser Disc Player will most likely require an RCA to BNC adapter. An adapter of this type can generally be purchased at a local electronics store.

- The BNC output connectors of the Sentosa_{xi}/Lancia_{xi} should be connected to the display device using high resolution coaxial cable such as Extron's BNC-4 or BNC-5.

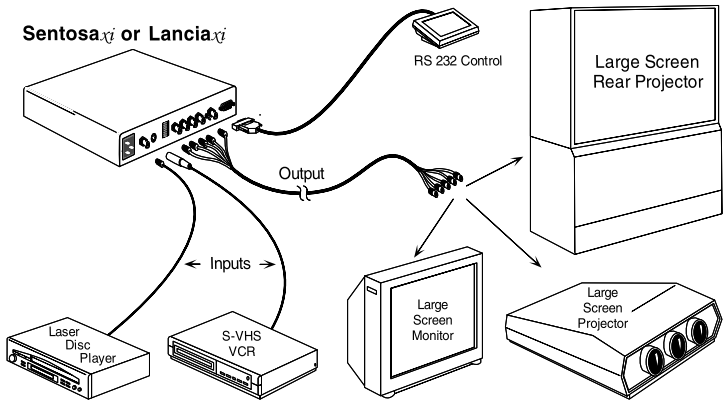

Connecting the RS-232 Cable

To connect the Sentosa_{xi}/Lancia_{xi} to a computer, refer to the picture below and connect the user supplied RS-232 cable from the Host system/device serial port to the Sentosa_{xi}/Lancia_{xi} connector labeled RS-232.

-  — When connecting to the RS-232 port, connect only pins 2, 3 and 5. Pins 1, 4 and 6 - 9 must be left unconnected as they are reserved for "Remote Contact Closure Operation" – see page 3-5.

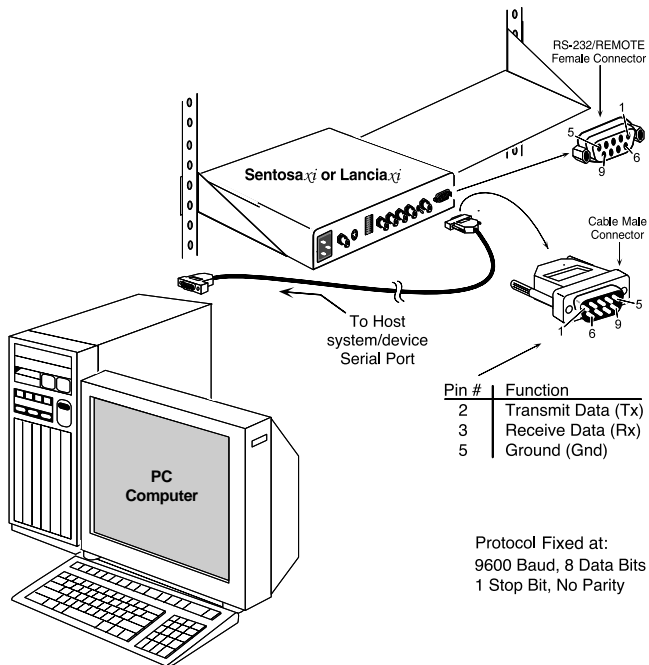

Switch Settings

The switches on the DIP switch module used in the Sentosaxi/Lanciaxi are the “rocker” type (see end view drawing, below-right). The primary difference between the rocker type and the “slide” type (which could also be used) is the action required to change the position of the switch. To change the position of the rocker type switch, press down against the desired end (enable or disable) with a pointed object. To change the position of the slide switch, a small screwdriver is used to push (slide) the switch to the desired position (enable/on or disable/off).

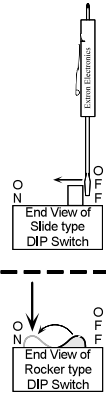

Set the DIP Switches, located on the rear panel of the Sentosaxi/Lanciaxi, as required. The right side of the switch module is the enable position. (See DIP switch descriptions beginning at the bottom of this page.)

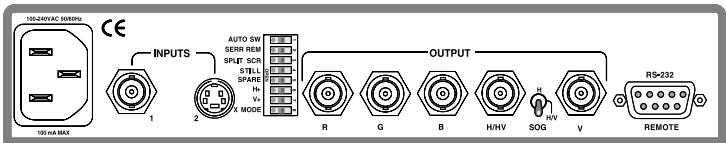

Sentosaxi Rear Panel

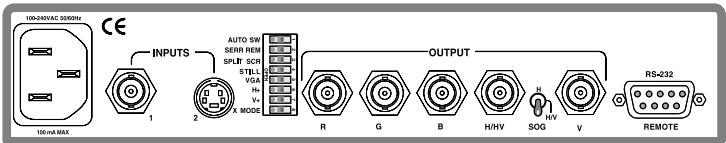

Lanciaxi Rear Panel

Select the desired sync type using the H/HV/SOG toggle switch (located between the H/HV and V BNC connectors – see rear panel drawings above). Switch positions are:

- Top (H) = Horizontal sync on H/HV BNC, Vertical sync on V BNC
- Center (HV) = Composite HV sync on H/HV BNC
- Bottom (SOG) = Sync on Green BNC

DIP Switch Module (Sentosaxi and Lanciaxi)

The function of each DIP switch follows. The switches on the DIP Switch module are numbered 1 – 8 from top to bottom.

#1 – **AUTO SW** (Auto Switch Mode)

Disabled – Input selection is a manual operation through the front panel input selection switch or through the RS-232/Contact REMOTE connector.

Enabled – The input with video present will be selected automatically. Input 2 has priority (If video is present on both connectors, Input 2 will be selected.)

#2 – SERR REM (Serration Pulse Removal)

Disabled – Serration pulses are passed along with the vertical sync pulse.

Enabled – Serration pulses are removed from the output vertical sync pulse.

#3 – SPLIT SCR (Sentosaxi = Tri-screen, Lanciaxi = split screen)

Disabled – Split screen is disabled.

Enabled – Split screen (Demo Mode) displays the selected input interlaced video on the left side of the screen. The remainder of the screen depends on the model.

- Sentosaxi displays line quadrupled video in the center of the screen and line doubled video on the right side of the screen.
- Lanciaxi displays line doubled video on the right half of the screen.

#4 – STILL (STILL Mode)

Disabled – Motion Compensation Mode – optimizes motion video such as from VCRs, DVDs, Tuners, etc.

Enabled – Motionless video, such as text, will have enhanced resolution for easier reading.

#5 – VGA (VGA Mode) Lanciaxi only, SPARE on Sentosaxi

Disabled – The output will have twice the number of input horizontal lines per screen scan. For NTSC, the number of horizontal lines per screen scan, normally 262.5, will double to 525. For the PAL system, the number of horizontal lines per screen scan, normally 312.5, will double to 625 lines. (This description assumes that SW#3, Split Screen, is disabled).

Enabled – Active vertical resolution becomes 480 non-interlaced horizontal lines, regardless of the input.

#6 – H+ (Horizontal Sync Polarity Positive)

Disabled – The horizontal sync polarity will be negative.

Enabled – The horizontal sync polarity will be positive.

#7 – V+ (Vertical Sync Polarity Positive)

Disabled – The vertical sync polarity will be negative.

Enabled – The vertical sync polarity will be positive.

#8 – X MODE (Executive Mode)

Disabled – All front panel operations are enabled.

Enabled – Front panel picture controls (Color, Tint, Contrast and H Shift) are locked out. MIN and MAX LEDs are on together to indicate that Executive Mode is enabled.

Front and Rear Panels (Sentosaxi and Lanciaxi)

Front and rear panel component descriptions follow.

Front Panel

The letters next to the following descriptions match circled letters in the drawing below. Descriptions apply to Sentosaxi & Lanciaxi.

- A **Power LED** – If the LED is on, power is on. If AC voltage is available to the device, power will be on. When power is initially applied, all front panel LEDs flash to indicate power up OK.
- B **Input Selection Push Button Switch** – Select Input 1 (composite video) or Input 2 (S-Video).
- C **Input 1 LED** – Composite video is selected if this LED is on.
- D **Input 2 LED** – S-Video is selected if this LED is on.
- E **Freeze Push Button Switch** – Selects Freeze Frame or Motion mode (toggles between the two).
- F **Freeze LED** – Freeze Frame Mode is active if this LED is on. While in this mode, the output will be a single frame of video until the Freeze button is pressed.



The Color, Tint, Contrast and H Shift Controls described below are the continuous turning type – they have no mechanical limits. When the minimum or maximum limit is reached, the MIN or MAX LED will blink. MIN and MAX LEDs both blink once when the control passes through the default value. Rotation of a control will increase or decrease a decimal value which is stored in a nonvolatile memory. The memory stores two sets of decimal values, one set for each input. Each set includes the current values for the four controls.*

- G **Color** – Color intensity adjustment control.
- H **Tint**** – Tint (Hue) adjustment control.
- I **Contrast** – Contrast and Brightness control.
- J **H Shift** – Screen image horizontal centering control.



*To reset the Color, Tint, Contrast and Horizontal Shift values **press** and **hold** the Freeze button during power-up. Values for the current input will reset to the factory default settings.*

- K **MIN LED*** – Minimum limit reached if blinking and MAX LED OFF.
- L **MAX LED*** – Maximum limit reached if blinking and MIN LED OFF.

* – MIN or MAX LEDs blink when rotation of a control continues after its value has reached a limit. *There is no indication of a value at a limit unless its control is rotated. MIN and MAX LEDs ON together indicate X Mode and the controls are locked out (see #8, page 2-4).*

** *If a control does not apply to the video type in use, the MIN and MAX LEDs both blink continuously while the control is being rotated (for example, rotating the Tint control with PAL video input).*

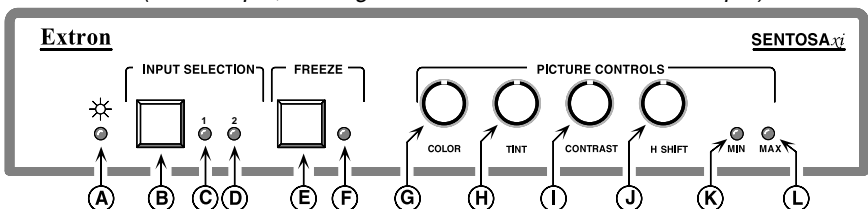

Rear Panel

The following descriptions are keyed* to the rear panel drawing below. Sentosaxi panel is pictured but also applies to Lanciaxi.

- M AC Power connector
Standard IEC AC power connector (100 - 240 VAC 50/60 Hz)
- N **1** = Input connector #1
BNC connector for composite input video.
- O **2** = Input connector #2
4 Pin mini-DIN connector for S-Video input.
- P Switch Module
8 DIP switches described on pages 2-3 & 2-4.
- Q **R** = Red output BNC connector
For Red video output
- R **G** = Green output BNC connector
For Green video output (plus HV sync if H/HV/SOG switch = SOG)
- S **B** = Blue output BNC connector
For Blue video output
- T **H/HV** sync output BNC connector
The output from this connector is dependent on the setting of the three position switch described in "U" below.
- U **H/HV/SOG** 3-position switch
The position of this switch determines horizontal and vertical sync output location.
Switch = top (H) position, H sync on H/HV BNC, V sync on V BNC
Switch = center (HV) position, Composite HV sync on H/HV BNC
Switch = bottom (SOG) position, Sync on Green BNC
- V **V** = Vertical Sync Output BNC Connector
The output from this connector is dependent on the setting of the three position switch described in "U" above.
- W **RS-232/Contact REMOTE** 9 pin connector
When connected to a serial port on a Host computer/device, remote (manual or program) control of the Sentosaxi or Lanciaxi is possible. A third party remote contact closure device may be connected to this connector (see Page 3-5, "Remote Contact Closure Operation", for details).

* – Letters next to the descriptions above are keyed to the circled letters in the drawing below.

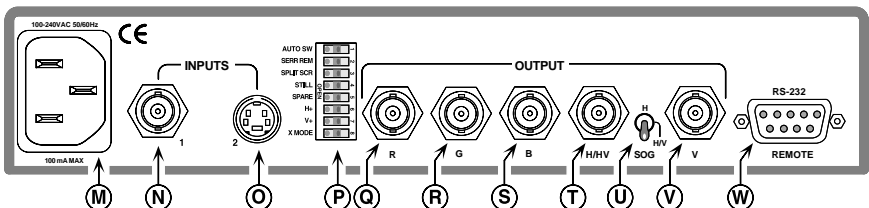

Operation

Sentosaxi

The Sentosaxi LQ converts interlaced video to non-interlaced video with four times the original number of horizontal scan lines. For NTSC 3.58/NTSC 4.43 video, each field of 262.5 lines is quadrupled to create a 1050 line non-interlaced screen scan. The same process applies to PAL/SECAM video, except the field consists of 312.5 horizontal lines which, when quadrupled, becomes 1250 horizontal lines/screen. The Sentosaxi output horizontal scan frequency is 63 kHz NTSC 3.58/NTSC 4.43 and 62.5 kHz PAL/SECAM while vertical scan remains 60 HZ for NTSC 3.58/NTSC 4.43 and 50 HZ for PAL/SECAM.

Lanciaxi

The Lanciaxi LD converts interlaced video to non-interlaced video with double the original number of horizontal lines. For NTSC 3.58/NTSC 4.43 video, each field of 262.5 lines is doubled to create a 525 line non-interlaced screen scan. The same process applies to PAL/SECAM video, except the field consists of 312.5 horizontal lines which, when doubled, becomes 625 horizontal lines/screen scan. The Lanciaxi output horizontal scan frequency is 31.5 kHz NTSC 3.58/NTSC 4.43 and 31.25 kHz PAL/SECAM while vertical scan remains 60 HZ for NTSC 3.58/NTSC 4.43 and 50 HZ for PAL/SECAM.



— One exception to the above Lanciaxi description occurs when the VGA DIP switch on the Lanciaxi rear panel is in the enable position. This results in a 480, non-interlaced, horizontal line screen scan regardless of the input type.

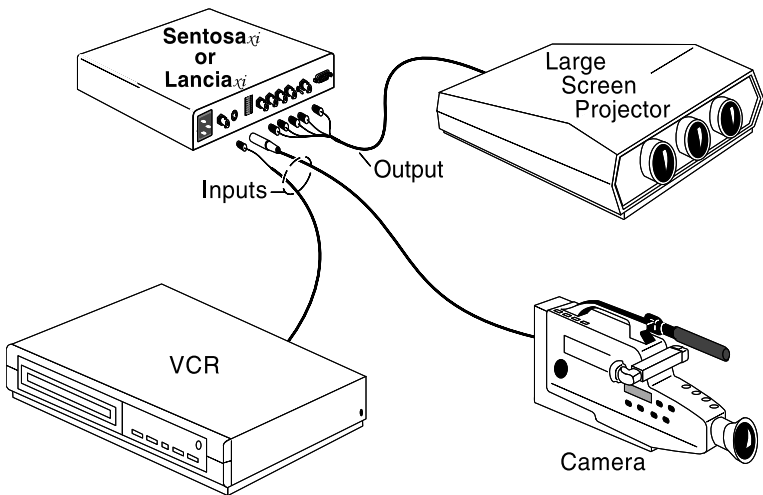

Application with inputs to the Sentosaxi or Lanciaxi provided by a VCR and a camcorder.

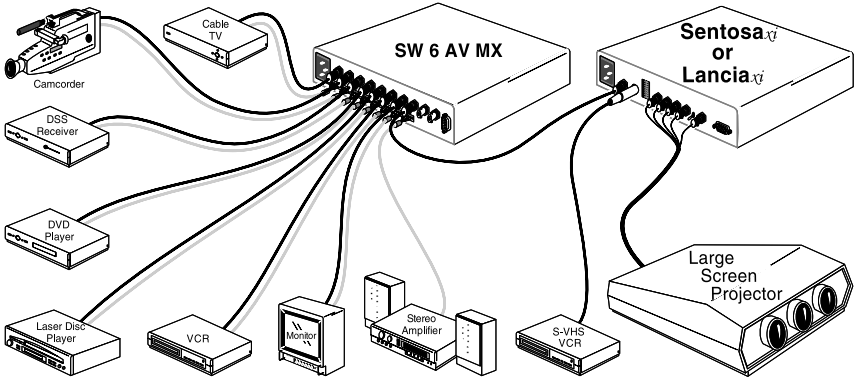

Application with one input to the Sentosaxi or Lanciaxi provided by an SW 6 AV MX switcher.

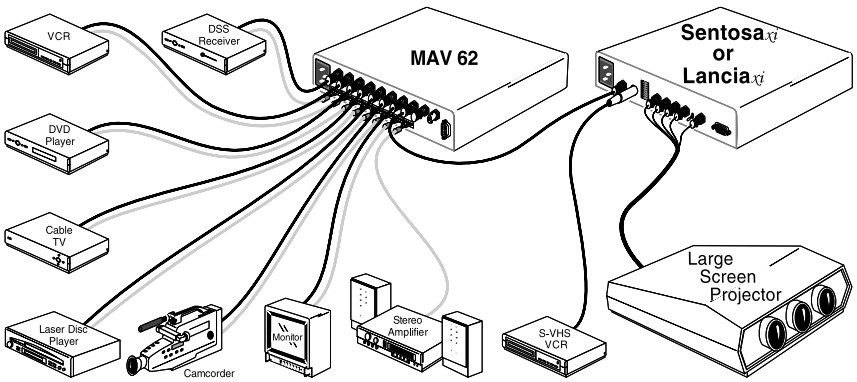

Application with one input to the Sentosaxi or Lanciaxi provided by a MAV 62 switcher.

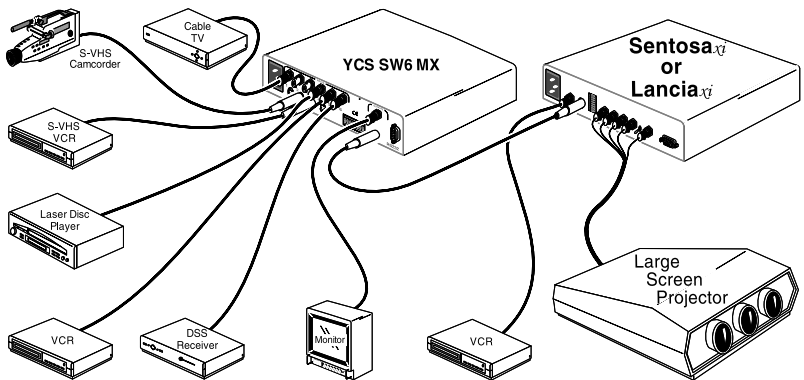

Application with one input to the Sentosaxi or Lanciaxi provided by a YCS SW6 MX switcher.

Video Loop-Back Application

Pictured below is an application using the Video Loop Back output from a System 8/10 PLUS Switcher as the input to a Sentosaxi LQ or a Lanciaxi LD. The output of the Sentosaxi/Lanciaxi is connected back to the last input (input 8 or 10) of the System 8/10 PLUS Switcher. This technique enables Line Doubling/Line Quadrupling for all inputs to the System 8/10 PLUS.

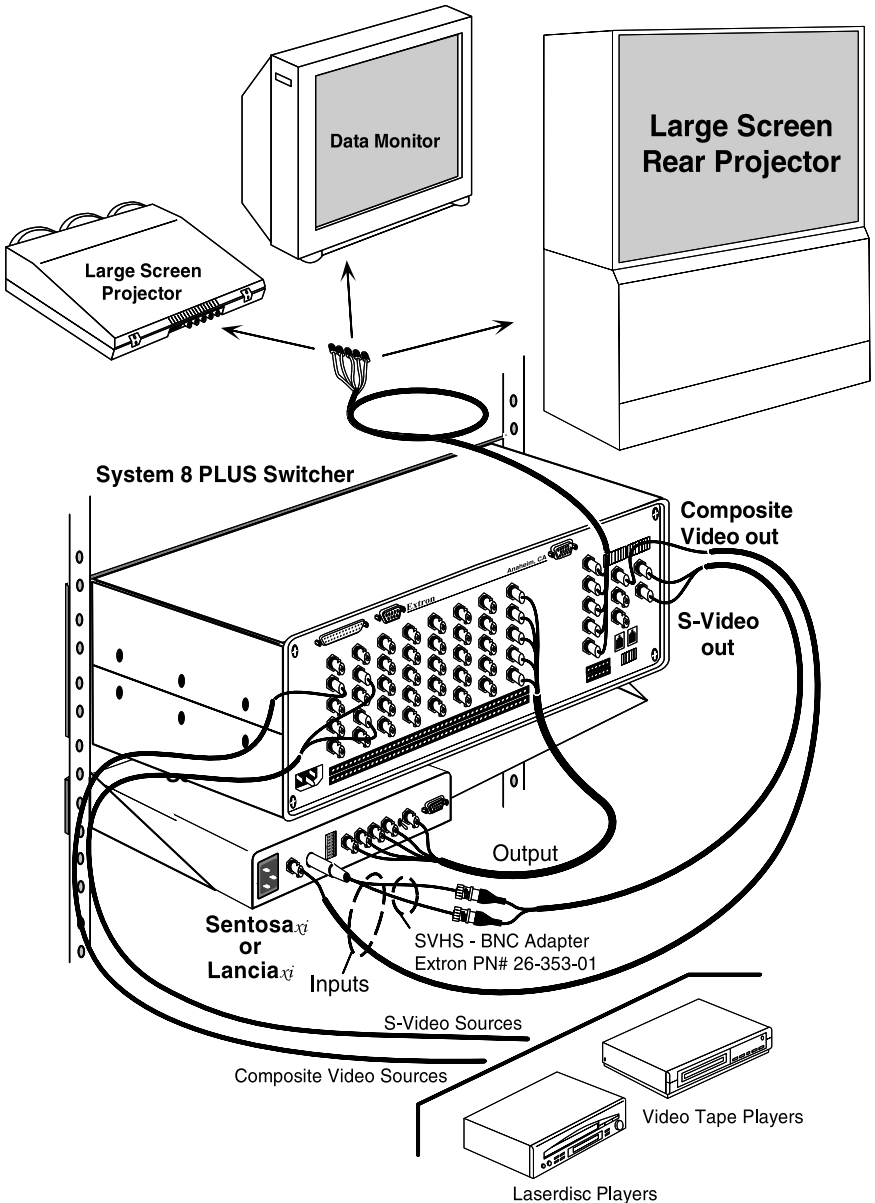

*Extron's SENTOSA_{xi}LQ & LANCIA_{xi}LD
User's Manual*



Chapter Three

RS-232/REMOTE Control

RS-232 Control

Windows Compatible Software

RS-232/REMOTE Control

The Sentosaxi/Lancixi include an RS-232 communications interface which allows it to be controlled from a Host device/system. RS-232 connector pin assignments and protocol are shown below.

Pin #	Function
2	Transmit Data (Tx)
3	Receive Data (Rx)
5	Ground (Gnd)

Protocol:

9600 Baud, 8 Data Bits
1 Stop Bit, No Parity

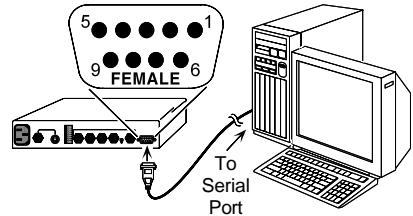

When RS-232 data is received by the Sentosaxi/Lancixi, the front panel MIN LED will blink once then the MAX LED will blink once to indicate that RS-232 data is being received. In EXEC mode the MIN and MAX LEDs are solid ON (see Page 2-5), they don't blink. A contact closure device may also be used on the RS-232 connector, See "Remote Contact Closure Operation" – Page 3-5.

Host/Sentosaxi/Lancixi Communications

The Sentosaxi/Lancixi treats any character that it receives on the RS-232 port as a possible command but accepts only a limited number as legal commands. There are no codes required to say that a command is coming, or that a command has ended. A simple command may be a single character typed on a keyboard and does not require any special characters before or after. (i.e. It is not necessary to press "enter" from the keyboard.) Simple commands could be from a terminal, or any other Host device.

When the Sentosaxi/Lancixi receives a command and determines that it is valid, it will execute the command and send a response back to the controlling (Host) device. If the Sentosaxi/Lancixi determines that the command is invalid, an error response will be returned to the Host. All responses from the Sentosaxi/Lancixi to the Host end with a carriage return and a line feed (CR/LF) signaling the end of the Response character string (string = one or more characters).

Using the Command/Response Table

The table on the following page lists those commands which the Sentosaxi/Lancixi recognizes as valid and the responses that will be returned to the Host. The Description column defines the Command, the results of executing the Command, or a definition of the response. An example of each command is shown to the right of the Command Description column. The error response format is shown at the bottom of the table. Possible error types and causes are shown on page 3-3 followed by Sentosaxi/Lancixi initiated messages.

A dot (·) when used in the table represents a space. It is not displayed.

COMMAND/RESPONSE TABLE

Definitions and Abbreviations: ␣ = CR/LF · = space [X1] = 1 or 2 (Input #) [X2] = 1 – 127 [X3] = 0 or 1, 0 = OFF, 1 = ON
 [X4] = Input type (T), 0 = no input, 1 = NTSC 3.58, 2 = PAL, 3 = NTSC 4.43, 4 = SECAM [X5] = Software version x.xx [X6] = 1 – 63

COMMAND		RESPONSE		Command Description	Example Commands and Responses		
ASCII	HEX	to Host			Command	Response	Action/Explanation
[X1]!	[X1] _h 21 _h	C[X1] ␣		Select input channel (C) [X1]	2!	C2 ␣	Select Input channel #2
F	7C _h	Frz1 ␣		Freeze ON (ASCII F or accepted)	F	Frz1 ␣	Freeze (Frame) Video
f	7E _h	Frz0 ␣		Freeze OFF (ASCII f or ~ accepted)	f	Frz0 ␣	Release Freeze Mode
i	69 _h	(Same as I below)		Information request	i	C2·T1·Col65·Tin70·Con100·Hph39·Frz0 ␣	
I	49 _h	C[X1]·T[X4]·Col[X2]·Tin[X2]·Con[X2]·Hph[X6]·Frz[X3] ␣			I	C2·T1·Col65·Tin70·Con100·Hph39·Frz0 ␣	
n	6E _h	(Same as N below)		Request for part number	n	N60-213-01 ␣	60-213-01 = Lancia
N	4E _h	N60-213-01 ␣		Request for part number	N	N60-229-01 ␣	60-229-01 = Sentosa
q	71 _h	(Same as Q below)		Query software version	q	QVER·1.23 ␣	(1.23 is example only)
Q	51 _h	QVER·[X5] ␣		Query software version	Q	QVER·1.23 ␣	Software version 1.23
[X2]C	[X2] _h 43 _h	Col[X2] ␣		Set color value (Col) to [X2]	25C	Col25 ␣	Color value to 25
{C	7B _h 43 _h	Col[X2] ␣		Increment color value	{C	Col26 ␣	Color value + 1
}C	7D _h 43 _h	Col[X2] ␣		Decrement color value	}C	Col25 ␣	Color value – 1
[X2]T	[X2] _h 54 _h	Tin[X2] ␣		Set tint value (Tin) to [X2]	32T	Tin32 ␣	Tint value to 32
{T	7B _h 54 _h	Tin[X2] ␣		Increment tint value	{T	Tin33 ␣	Tint value + 1
}T	7D _h 54 _h	Tin[X2] ␣		Decrement tint value	}T	Tin32 ␣	Tint value – 1
[X2]^	[X2] _h 5E _h	Con[X2] ␣		Set contrast value (Con)to [X2]	99^	Con99 ␣	Contrast value to 99
{^	7B _h 5E _h	Con[X2] ␣		Increment contrast value	{^	Con100 ␣	Contrast value + 1
}^	7D _h 5E _h	Con[X2] ␣		Decrement contrast value	}^	Con99 ␣	Contrast value – 1
[X6]H	[X6] _h 48 _h	Hph[X6] ␣		Set horizontal phase value (Hph) to [X6]	39H	Hph39 ␣	Set H. Phase Value to 39
{H	7B _h 48 _h	Hph[X6] ␣		Increment Hph value	{H	Hph40 ␣	Horiz. Phase Value + 1
}H	7D _h 48 _h	Hph[X6] ␣		Decrement Hph value	}H	Hph39 ␣	Horiz. Phase Value – 1
		Exx ␣		Error Response			see "Error Responses" – next page

Time-out

Pauses 10 seconds or longer between command sequence ASCII characters will result in a Time-out. The command operation is aborted with no other indication that a Time-out has occurred.

Error Responses

When a command is received from the Host, if the Sentosaxi/Lanciaxi detects an error, it will return an error response. Possible error responses with a brief description follow:

- E01 ↵ Invalid input channel number (out of range)
- E06 ↵ Auto-switch mode active (rear panel DIP switch #1 =enable)
- E10 ↵ Invalid command (Command received is invalid)
- E13 ↵ Invalid value (out of range)

Sentosaxi/Lanciaxi-Initiated Messages

When a local event takes place, such as a front panel operation or an error condition, the Sentosaxi/Lanciaxi responds by sending a message to the Host. No response from the Host is expected. These Sentosaxi/Lanciaxi-initiated messages are listed below (underlined to identify actual message).

(C) Copyright 1998, Extron Electronics (Model), V x.xx ↵

This message is initiated by the Sentosaxi/Lanciaxi when it is first powered on. (Model = Sentosaxi or Lanciaxi), (x.xx is the software version number)

Reconfig ↵ *This message is initiated by the Sentosaxi/Lanciaxi when there is a change in the selected input or any picture control setting.*

RS-232 - Overrun ↵ *These Sentosaxi/Lanciaxi-initiated messages indicate an RS-232 communication error.*
RS-232 - Noise ↵ *Possible causes are RS-232 connection problem, Baud rate, etc.*
RS-232 - Framing ↵
RS-232 - Overflow ↵

RAM Test Failed ↵

ROM Checksum Failed ↵

Serial EEPROM Checksum Failed ↵ *Call Extron Technical Support if any of these Sentosaxi/Lanciaxi-initiated messages are reported.*
6811 EEPROM Checksum Failed ↵

New 6811 Installed ↵

New Serial EEPROM Installed ↵

Invalid Jumpers - Unknown - xxxx ↵ *Call Extron Technical Support.*

Factory Defaults Reset on Channel #1 ↵ *Reported if Freeze button is depressed during power-up.*
Factory Defaults Reset on Channel #2 ↵

Lancia/Sentosa Control Software

The Lancia/Sentosa Control Program is Windows® compatible and provides remote control of the following functions:

- Input selection
- Video adjustments
- Freeze frame control

Installing the Software

The program is contained on a single 3.5" diskette and will run from the floppy drive. However, it will be more convenient to load and run it from the hard drive. It can be installed on the user's hard-drive as follows:

1. Insert the Extron software diskette into the floppy drive.
2. From the Windows Program Manager **File** menu, click on **Run**.
3. Specify the disk drive and type "setup". For example, type A:\SETUP ←if the diskette is in drive A.

The program will occupy approximately 1 MB of hard drive space. The Windows installation will create (by default) a C:\LANCIA directory and will place 2 icons (LANCIA/SENTOSA Control Program and LANCIA/SENTOSA Help) into a group titled "Extron Electronics".

Using the Software

1. For information about program features, double click on the LANCIA/SENTOSA Help ICON in the Extron Electronics group. [Help can be accessed from its Icon (stand-alone) or from within the program by the Menu on the Main screen or by pressing F1 from any point within the program.]
2. To run the software, double click on the LANCIA/SENTOSA Control Program ICON in the Extron Electronics group.
3. A Comm menu will be displayed on the screen. Click on the Comm Port that is connected to the Lancia*xi*/Sentosa*xi* RS-232 connector.
4. The Extron LANCIA/SENTOSA Control Program window displays current input selection and control values (see Figure 3-4 below).

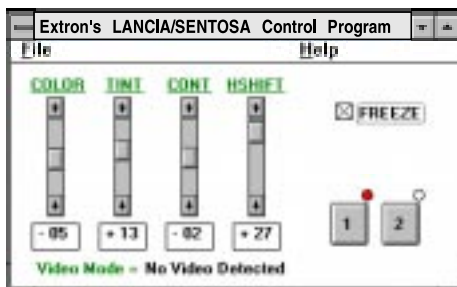
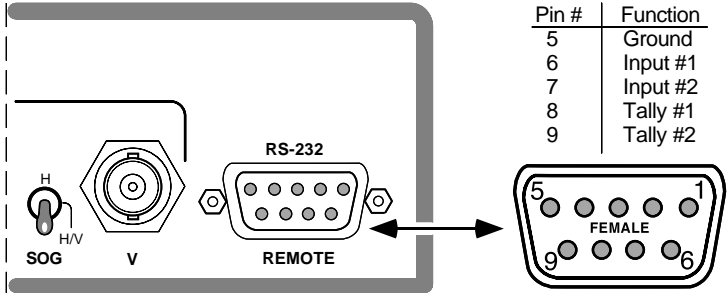

Figure 3-4

Remote Contact Closure Operation

The RS-232 connector provides a way to control the Sentosa*xi*/ Lanci*xi* using a remote contact closure device. This is made possible through the use of pins that are not normally used by the RS-232 interface. The contact closure pin assignments are shown below



To select a different input number through the RS-232 connector, momentarily short the pin for the desired input number (#) to logic ground (pin 5). To force one of the two inputs to be selected continuously, leave the short to logic ground in place, this will override front panel input selection.

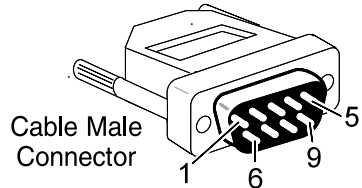

The Tally pins can be used for remote indication of the selected input. Tally #1 or Tally #2 (pins 8 and 9) will indicate the selected input # with a logic low (0 volts), the Tally pins are normally at logic high (5 volts).

The schematics shown below may be used as a guide to design and build indicator circuits for the Tally pins. Since there is no voltage source on the RS-232 connector, an external voltage source will be required.

LED Indicator Circuit

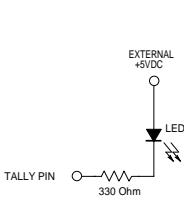

Incandescent Lamp Circuits

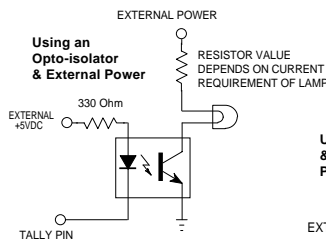

RECOMMENDED RELAYS		
MANUFACTURER	GENERAL	LOW CURRENT
Aromat	DS2	TQ
ITT/Panasonic	R-Z-5C	ASW
Omron	G5Y	G6H

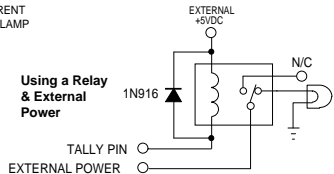



Appendix A

Other Reference Material

Remote Contact Closure Operation

Accessories and Part Numbers

Limited Warranty

Accessories/Part Numbers

BNC-4 HR Cable

BNC-4-3'HR (3 feet/0.9 meters)	26-210-01
BNC-4-6'HR (6 feet/1.8 meters)	26-210-02
BNC-4-12'HR (12 feet/3.6 meters)	26-210-03
BNC-4-25'HR (25 feet/7.5 meters)	26-210-04
BNC-4-50'HR (50 feet/15.0 meters)	26-210-05
BNC-4-75'HR (75 feet/23.0 meters)	26-210-06
BNC-4-100'HR (100 feet/30.0 meters)	26-210-07
BNC-4-150'HR (150 feet/45.0 meters)	26-210-08
BNC-4-200'HR (200 feet/60.0 meters)	26-210-09
BNC-4-250'HR (250 feet/75.0 meters)	26-210-54
BNC-4-300'HR (300 feet/90.0 meters)	26-210-53
BNC-4 Mini-HR Bulk (300'/90m up to 5000'/1500m)	22-073-01

BNC-5 HR Cable

BNC-5-3'HR (3 feet)	26-260-15
BNC-5-6'HR (6 feet/1.8 meters)	26-260-01
BNC-5-12'HR (12 feet/3.6 meters)	26-260-02
BNC-5-25'HR (25 feet/7.5 meters)	26-260-03
BNC-5-50'HR (50 feet/15.0 meters)	26-260-04
BNC-5-75'HR (75 feet/23.0 meters)	26-260-16
BNC-5-100'HR (100 feet/30.0 meters)	26-260-05
BNC-5-150'HR (150 feet/45.0 meters)	26-260-12
BNC-5-200'HR (200 feet/60.0 meters)	26-260-06
BNC-5-250'HR (250 feet/75.0 meters)	26-260-18
BNC-5-300'HR (300 feet/90.0 meters)	26-260-14
BNC-5 Mini-HR Bulk (300 feet up to 5000 feet)	22-008-01

Lancia <i>xi</i> Line Doubler	60-213-02
Sentosaxi Line Quadrupler	60-229-02

Sentosaxi/Lancia <i>xi</i> Label	33-244-01
Sentosaxi/Lancia <i>xi</i> User's Manual	68-254-01

19" 1U Universal Rack Shelf	60-190-01
-----------------------------------	-----------

RCA-6' - RCA Male to Male, 6 feet/1.8 meters	26-345-01
--	-----------

SVHS (S-Video) Extension Cables

SVHS-6' - Male to Male S-Video Cable, 6 feet/1.8 meters	26-316-02
SVHS-12' - Male to Male S-Video Cable, 12 feet/3.6 meters	26-316-03
SVHS-20' - Male to Male S-Video Cable, 20 feet/6 meters	26-316-01
SVHS-30' - Male to Male S-Video Cable, 30 feet/9.1 meters	26-316-04
SVHS-50' - Male to Male S-Video Cable, 50 feet/15 meters	26-316-05
SVHS-75' - Male to Male S-Video Cable, 75 feet/23 meters	26-316-06
SVHS-100' - Male to Male S-Video Cable, 100 feet/30 meters	26-316-07